

# JAGADIS CHANDRA BOSE: MILLIMETRE WAVE RESEARCH IN THE NINETEENTH CENTURY

Darrel T. Emerson  
National Radio Astronomy Observatory<sup>1</sup>  
949 N. Cherry Ave.; Bldg. 65  
Tucson, Arizona 85721  
demerson@nrao.edu

## ABSTRACT

In the last decade of the nineteenth century, many experimenters began working with the newly discovered “Hertzian Waves.” J.C. Bose in particular investigated the properties of waves and materials in the short cm- to mm-wave part of the spectrum. He used waveguides, horn antennas, dielectric lenses, various polarisers, and even semiconductors at frequencies as high as 60 GHz. Some of his work is surprisingly relevant today.

## 1. INTRODUCTION

More than 100 years ago, experiments were being carried out with electromagnetic radiation generated and detected at wavelengths as short as 5 mm (60 GHz.) The results were published in the scientific journals of the time, and scientific lectures and demonstrations were delivered before distinguished scientific audiences (Figure 1). However, at about the time of the first transatlantic signalling demonstrations by Marconi (1901), experimentation at these wavelengths gradually ceased. It was really not until World War II that interest in microwaves returned. Some of the early work in millimetre and short-centimetre waves was only rediscovered in the 1950s (e.g. review by Ramsay, 1958) [1]; parts of Bose’s work are surprisingly relevant today.

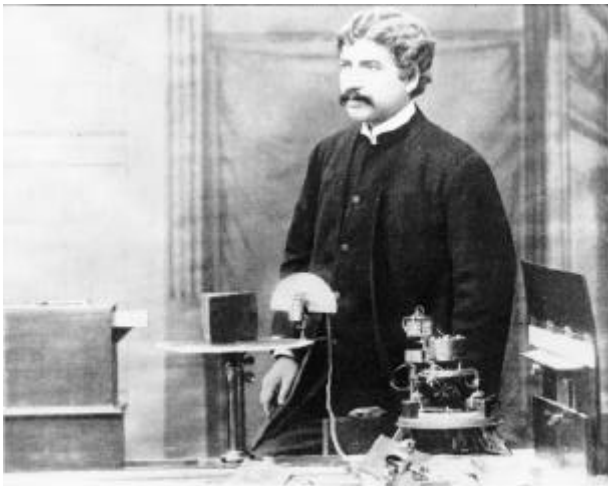

Figure 1. J.C. Bose at the Royal Institution, London, 1897 [8].

<sup>1</sup>The National Radio Astronomy Observatory is a facility of the National Science Foundation, operated under cooperative agreement by Associated Universities, Inc.

© 1997 IEEE. Some of this material is reprinted, with permission, from IEEE Transactions on Microwave Theory and Techniques; Vol. 45, No. 12, pp. 2267-2273; December 1997.

## 2. J.C. BOSE

Jagadis Chandra Bose was born in India in 1858; his early education was received in India [2] [3] [4] [5]. In 1880 he moved to London to study medicine, but because of ill health moved after one year to Cambridge. He won a scholarship to study Natural Science at Christ’s College, where his studies included Geology, Physics, Chemistry and Botany. He was a pupil of Lord Rayleigh, with whom he was to maintain a lifelong friendship. Figure 2 shows a handwritten greeting from Bose to Lord Rayleigh, at the front of one of his later books; the author recently discovered this at the library of the University of Arizona [6].

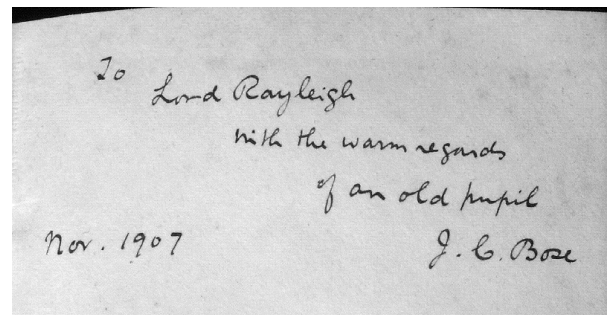

Figure 2. A handwritten note from Bose to Lord Rayleigh, found recently in a copy of Bose’s “Comparative Electrophysiology” at the library of the University of Arizona [6].

After gaining his degree in Natural Sciences at the University of Cambridge in 1884, J.C. Bose returned to India to take up the position of officiating professor of physics at the Presidency College, Calcutta. Strongly influenced by Rayleigh, his teaching included practical demonstrations. He set up a small laboratory at the Presidency College, and was able to demonstrate the newly discovered X-rays. The book “The Work of Hertz and his Successors” by Oliver Lodge [7] caught his interest, and he began research particularly into short wavelength electromagnetic radiation. In the last few years of the 19th century he used, and in some cases invented, many now commonplace microwave components, including waveguide, dielectric lenses and prisms, horn and lens-waveguide radiators, microwave absorber and semiconductor detectors. Soon after the turn of the century, he became interested more in plant growth and plant life, and to this day, at least in India, is much more well known for this later work. However, his earlier work with short wavelength electromagnetic waves may be much more important, and more epoch making.

## 3. MILLIMETRE WAVE RESEARCH

Figure 1 shows J.C. Bose lecturing at the Royal Institution in London, in 1897 [8]. He experimented using wavelengths from 2.5 cm or longer up to 5 mm (60 GHz). He developed a

portable version of his apparatus for demonstrations such as shown in Figures 1 and 3.

Figure 3 shows a matching diagram to Figure 1. He used circular waveguide, and the "collecting funnel" (F) is a pyramidal electromagnetic horn antenna, first used by Bose. The radiation was generated by spark transmissions, using resonant structures to define the wavelength of emission; the wavelength was measured by a reflecting diffraction grating

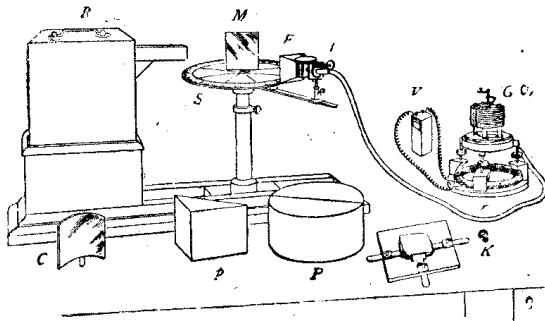

R, radiator; S, spectrometer-circle; M, plane mirror; C, cylindrical mirror; p, totally reflecting prism; P, semi-cylinders; X, crystal-holder; F, collecting funnel attached to the spiral spring receiver; t, tangent screw, by which the receiver is rotated; V, voltaic cell; r, circular rheostat; G, galvanometer.

**Figure 3.** Bose's apparatus demonstrated to the Royal Institution in London in 1897 [13]. Note the waveguide radiator on the transmitter at left, and that the "collecting funnel" (F) is in fact a pyramidal electromagnetic horn antenna, first used by Bose.

consisting of different dimensions and spacings of metal strips [9]. He invented and used the waveguide-lens and horn antennas, examples being shown in Figures 4 and 5.

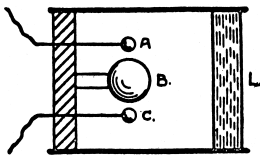

**Figure 4.** Bose's radiator with a lens (L) at the exit of the waveguide [1].

The antenna of Figure 5a shows the polarising grid built into the antenna; a similar system was used as a polarisation

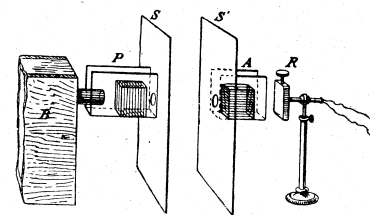

**Figure 5a.** One of Bose's transmitter antennas (being held on the right of the picture). Note the polarising grid; the spark gap is just visible behind the grid. In the background behind this antenna, part of the high voltage equipment used to generate the spark can be seen. At the left of the picture is the receiving horn.



**Figures 5b and 5c.** A closeup of the spark gaps normally mounted inside the transmitting antenna.

analyser at the receiving antenna. Bose studied the change in polarisation introduced by propagation through a variety of substances. Figure 6 is a diagram of his polarisation apparatus; the detector in this case is a spiral-spring receiver (see Figure 12)



Polarisation apparatus. B, the radiating box; P, the polariser; A, the analyser; S, S', the screens; R, the receiver.

**Figure 6.** Bose's diagram of his polarisation apparatus. Note the spiral-spring receiver to the right.

One of his free-space polarisers was a cut-off metal plate grating, consisting of a book (Bradshaw's Railway Timetable) with sheets of tinfoil interleaved in the pages, shown in Figure 7. He was able to demonstrate the polarising properties of the



**Figure 7.** One of Bose's polarisers was a cutoff metal-plate grating, consisting of a book (Bradshaw's Railway Timetable) with sheets of tinfoil interleaved within the pages.

book even without the tinfoil - the pages acting as dielectric sheets separated by small air gaps.

Another innovation introduced by Bose was the concept of macroscopic modelling, in this case using twisted jute polarisation elements as a molecular model, simulating the polarising effect on light of certain sugar solutions (Fig 8). Figure 9 shows one of the surviving twisted-jute polarisers used by Bose.

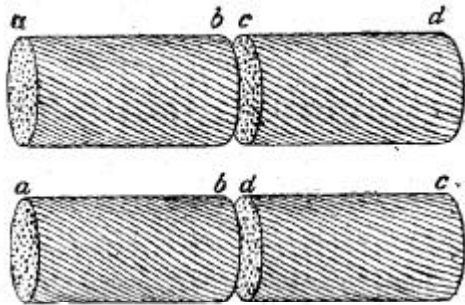

**Figure 8.** Bose's diagram of twisted-jute elements, simulating macroscopically the polarising effects of certain sugar solutions.



**Figure 9.** One of the twisted-jute polarisers used by Bose.

For detectors he used what are now recognised as semiconductor junctions - Bose later was awarded the world's first patent for a semiconductor. He characterised the I/V properties of his junctions, showing that they did not obey Ohm's law; in one experiment he even measured negative dynamic resistance in his junction [10]. Figure 10 shows examples of point-contact junctions used inside the receiving antenna of Figure 5a. Figure 11 shows the I-V characteristics measured by Bose, for different point contact pressures. The knee in the I-V curve is at about 0.45 volts - Bose had found that optimum detector sensitivity was obtained when a DC bias of this value was applied to his detectors.

He also used free-space detectors (Figure 12), which have since [11] been described as a "space-irradiated multi-contact semiconductor (using the natural oxide of the springs)." Figure 13 shows a photo of such a surviving receiver; it is a

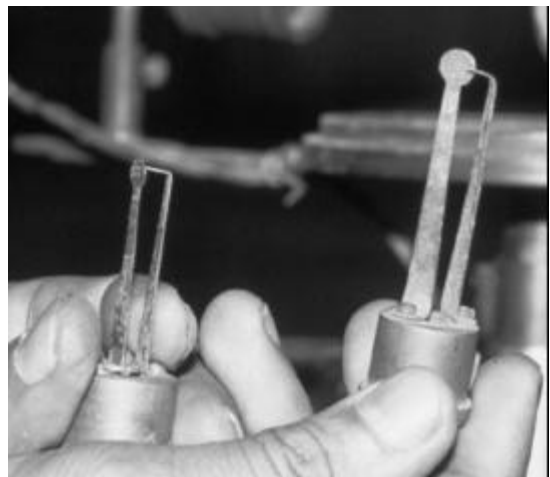

**Figure 10.** Two of Bose's point contact detectors, removed from the receiving antennas.

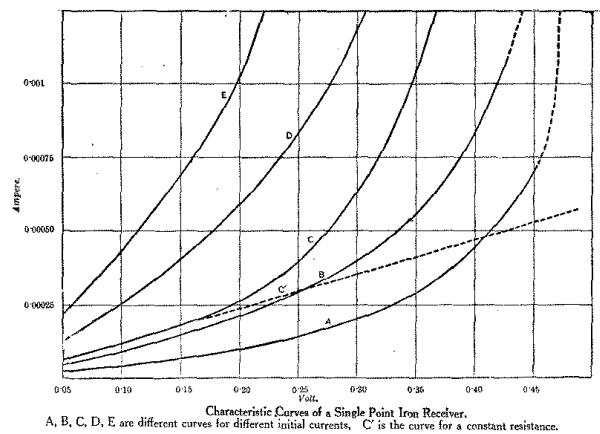

**Figure 11.** The I-V characteristics measured by Bose for a Single Point Iron Receiver. Note the similarity to modern semiconductor junctions, with a knee voltage of about 0.4 volts.

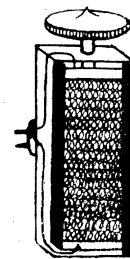

**Figure 12.** Bose's diagram of his spiral-spring receiver used for 5-mm radiation.



**Figure 13.** *One of Bose's free-space radiation receivers, recently described [11] as a "space-irradiated multi-contact semiconductor (using the natural oxide of the springs)." The springs are kept in place in their tray by a sheet of glass, seen to be partly broken in this photograph.*

tray of many small springs under slight compression; the oxide at the junctions causes semiconductor junctions which detect the radiation. Both the physical pressure, and the electrical bias (a value of 0.45 volts was found optimum) were adjusted to optimise sensitivity.

J.C. Bose made an automatic recorder to measure electrically the intensity of light from the sun and its variation throughout the day. The sensor was a selenium cell, and the intensity data were recorded automatically, plotting a graph via small sparks on a moving roll of paper [12]. He made an unsuccessful attempt to record short wavelength radio waves from the sun. He speculated in a discourse to the Royal Institution in 1897 (see p.88 of [13]) "It may be that the electric rays are absorbed by the solar or the terrestrial atmosphere." Solar radio emission was not detected, but at much longer wavelengths, until 1942. The 1.2 cm atmospheric water vapour absorption line, in the wavelength region where Bose carried out much of his research, was discovered during experimental radar work in 1944.

#### 4. THE DUAL PRISM ATTENUATOR, AND ESTIMATION OF WAVELENGTHS

One of the many devices studied by Bose was the double-prism attenuator. Two prisms (Figure 14) are arranged to be separated by a small, variable air gap. With a large air gap, the

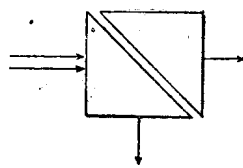

**Figure 14.** *Bose's 1897 diagram of the double-prism attenuator.*

incident radiation suffers total internal reflection, and is not transmitted into the dielectric of the second prism. With the prisms touching, the radiation sees no obstacle and passes right through the system. By adjusting the air gap, the attenuation is controlled. Figure 15 shows a photograph of a surviving adjustable dual prism, photographed at the Bose Institute in



**Figure 15.** *One of Bose's original double-prism attenuators, with adjustable air gap.*

1985. Figure 16 shows the prism between the transmitter antenna (left) and receiver in the typical arrangement used to measure the properties of the dual prism.

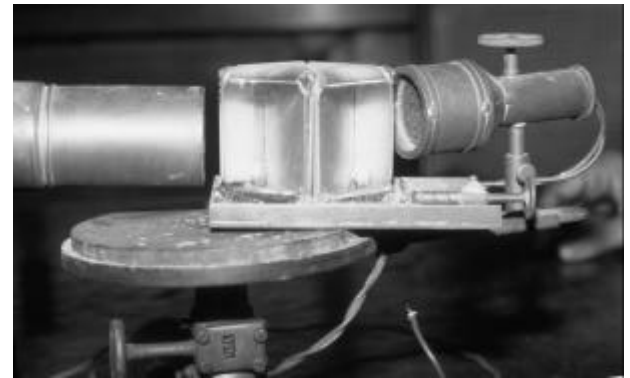

**Figure 16.** *A complete setup showing the transmitting antenna at left, with the receiving antenna at right. Note the adjustment screw on top of the receiving antenna, which is used to adjust the pressure of the point-contact detector (See Fig. 11). In the center is a rotating table (the "spectrometer circle" of Fig. 3) on which various microwave components (prisms, lenses, grids, polarisers, etc.) may be mounted for study. A dual-prism attenuator is shown in this photograph. The arrangement as shown is not yet properly aligned.*

The wavelength of emission from Bose's spark transmitters was defined by the resonant structure associated with his spark gaps and waveguide. He measured the wavelength associated with some of his structures using a reflection, concave diffraction grating; in his 1897 paper [9] he describes how with different structures he measured wavelengths of 1.84 and 2.36 cm. He showed that the wavelength of his emission scaled at least approximately with the dimensions associated with his spark generator. In other investigations, he assumed, reasonably, that the wavelength would scale with the physical dimensions of his emitter.

The theory of the dual-prism attenuator was published in 1910 by Schaeffer and Gross [14]. This theory, not available to Bose during his 19th century investigations, now permits an independent estimation of the wavelengths used by Bose for his dual prism experiments.

Bose measured the size of the air gap between the two prisms at which the intensity of the reflected and transmitted waves

were equal. In a separate experiment, using a measurement of the critical angle, at which total internal reflection inside the prism begins, he measured the refractive index of the dielectric - glass - at the wavelengths in use. His value is 2.04.

Figure 17 shows the calculated attenuation of the transmitted, and of the reflected rays, through a dual-prism system, the prisms having a refractive index of 2.04, as a function of the air gap between the prisms. The horizontal axis gives the air gap measured in wavelengths. It is seen that the reflected and transmitted powers are equal when the air gap is  $\sim 0.11$  wavelengths. To calculate the attenuation, equal powers were assumed in two orthogonal linear polarisations, parallel to and perpendicular to the plane of incidence. If the emission were to be 100% linearly polarised in either plane, the corresponding air gap would change by approximately  $\pm 20\%$ . Effects of diffraction have been ignored.

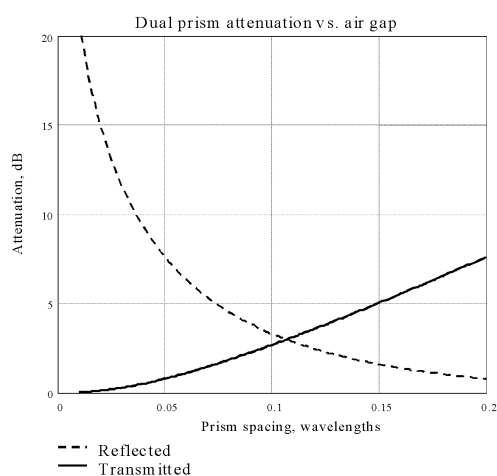

**Figure 17.** Attenuation of the transmitted and reflected waves vs. dual prism air gap in wavelengths.

For two different radiators, Bose found that gaps of 3.7 and 4.5 mm gave equal transmitted and reflected powers; the corresponding wavelengths derived from Fig 17 above are 3.45 and 4.17 cm. For the shorter wavelength, the radiator consisted of a conducting sphere of diameter 0.97 cm, with two smaller beads symmetrically either side. It is interesting to note that the fundamental mode of oscillation for an isolated conducting sphere this size (see Stratton [15]) corresponds to a wavelength of 3.54 cm, an estimate perhaps fortuitously close in value.

These wavelengths are somewhat greater than would be implied by a simple scaling of dimensions from the radiators used in Bose's diffraction grating wavelength measurements; however, the geometries used for the dual prism measurements were also somewhat different - a square waveguide, one inch on a side, was used during the diffraction grating measurements, as opposed to the somewhat larger circular waveguide during the dual prism experiment. It is also possible that in his diffraction grating experiments, a diffraction peak of emission from a higher resonance mode was detected, while the dual prism measurements respond to the total radiated energy. It would be very interesting to model the response of Bose's different transmitter configurations using modern software - or to make direct

measurements of the radiated spectra from the surviving equipment.

Recently at NRAO we have found the need for a quasi-optic attenuator for local oscillator injection at 230 GHz (1.3 mm) in a multi-feed system used for sensitive radio astronomical measurements at the 12 Meter Telescope at Kitt Peak. Bose's prism was the ideal solution; Figure 18 shows an array of 4 of the 8 adjustable dual-prism systems inside the receiver. In the published description of this NRAO system [16], Bose's paper published in the Proceedings of the Royal Society in London, in 1897, is rightly referenced.

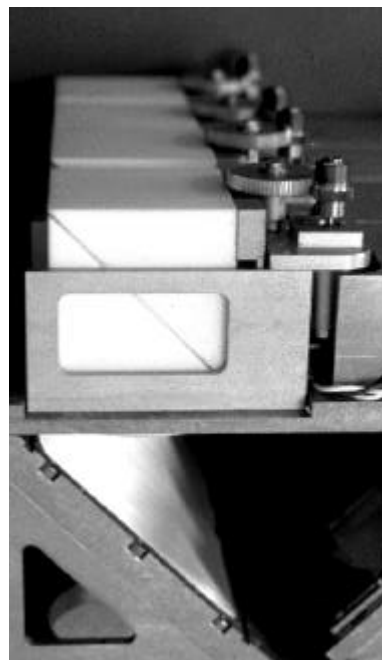
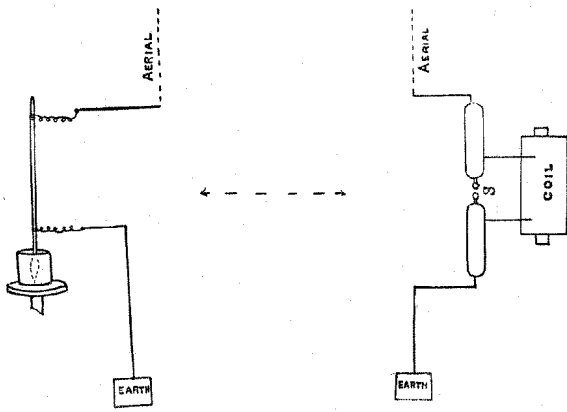

**Figure 18.** Four of the 8 double-prism attenuators used to control local oscillator injection into the NRAO 1.3-mm 8-beam receiver in use at the 12 Meter Telescope at Kitt Peak.

## 5. ENVIRONMENTAL STUDIES

Bose was always concerned about what we would today call environmental protection. One topic of great concern today is the biological effect of electromagnetic pollution. Bose began a study of the effect of longer wavelength electromagnetic radiation on plant growth; Figure 19 shows one of his experiments. The transmitter was situated 200 metres from the plant under study, and indeed a pronounced effect on the plant growth was found at different field strengths [17]. "Growing plants exhibit response to electric waves by modification of rate of growth. Feeble stimulus induces an acceleration, while strong stimulus causes a retardation in the rate of growth."

Another example of Bose being so remarkably ahead of his time is in the area of plant biophysics; his early measurements of action potentials and their propagation velocities have been precisely confirmed by quite recent work (e.g. Wayne 1994, Pickard 1973) [18] [19]. The whole subject of plant response to stimulation is becoming an important area of plant biophysics today [20].



**Figure 19.** Bose's measurement [17] of the effect of electromagnetic radiation on plant growth; the transmitter is situated 200 meters from the plant under study (left).

## 6. CONCLUSION

In his research into electromagnetic waves, his use and development of microwave components and the first use of semiconductors, Bose was clearly some 50 years ahead of his time. In 1895 he had demonstrated publicly remote signalling by wireless some two years before Marconi's famous Salisbury Plain demonstration of 1897. His work is still of value to us now, 100 years later - his speculation that that atmosphere was responsible for blocking short wavelength radio radiation, his groundbreaking measurements of the effect of electromagnetic radiation on plant growth, relate to topics of concern to many of us today, 100 years later.

## ACKNOWLEDGEMENTS

I wish to thank the Bose Institute in Calcutta for permission in 1985 to photograph some of the original equipment of J.C. Bose. I am grateful to Virginia Shepherd for pointing out recent references to J.C. Bose in the field of plant biophysics. I thank Mrs. Nancy Clarke for help and patience during the preparation of this manuscript.

## REFERENCES

- [1] John F. Ramsay, "Microwave Antenna and Waveguide Techniques before 1900," *Proc. IRE.*, pp. 405-415, February 1958.
- [2] Darrel T. Emerson, "The Work of Jagadis Chandra Bose: 100 Years of Millimeter-Wave Research," *IEEE Transactions on Microwave Theory and Techniques*, Vol. 45, No. 12, pp. 2267-2273, Dec. 1997.
- [3] Monoranjan Gupta, *Jagadis Chandra Bose, A Biography*. Bombay, India: Bhavan's Book University, 1952.
- [4] Bimalendu Mitra, *Sir Jagadis Chandra Bose: A Biography for Students*. Hyderabad-Bombay-Calcutta, India: Orient Longman, Ltd., 1982.
- [5] B. Mitra, "Early Microwave Engineering: J. C. Bose's Physical Researches during 1895-1900," *Science and Culture*, vol.50, pp.147-154, 1984.
- [6] Handwritten note found in *Comparative Electrophysiology*, J.C. Bose, Longmans, Green and Co., 1907; the Special Collections of the library of the University of Arizona.
- [7] Oliver Lodge, *Signalling Across Space Without Wires*. Fleet Street, London, U.K.: "The Electrician" Printing & Publishing Company, 1908, 4<sup>th</sup> Ed., p. 83. (First edition published in 1894 under the title, *The Work of Hertz and His Successors*.)
- [8] Photograph from *Acharya Jagadis Chandra Bose, Birth Centenary, 1858-1958*. Calcutta: published by the Birth Centenary Committee, printed by P.C. Ray, November 1958.
- [9] J.C. Bose, "On the determination of the wavelength of electric radiation by a diffraction grating," *Proc. Roy. Soc.*, vol. 60, pp.167-178, 1897.
- [10] J.C. Bose, "On the Change of Conductivity of Metallic Particles under Cyclic Electromotive Variation," originally presented to the British Association at Glasgow, September 1901, reproduced in *Collected Physical Papers*, J.C. Bose, Ed. New York, N.Y.: Longmans, Green and Co., 1927.
- [11] K.L. Smith, "Victorian Microwaves," *Wireless World*, pp. 93-95, September 1979.
- [12] "Life Movements in Plants," Vol IV, 1923, reproduced in *Collected Physical Papers*, J.C. Bose, Ed. New York, N.Y.: Longmans, Green and Co., 1927 pp 338-346
- [13] J.C. Bose, *Collected Physical Papers*. New York, N.Y.: Longmans, Green and Co., 1927.
- [14] C. Schaefer and G. Gross, "Untersuchungen ueber die Totalreflexion," *Annalen der Physik*, vol 32, p.648, 1910.
- [15] Stratton, J.A., 1941. "Electromagnetic Theory," McGraw-Hill Company. Chapter IX, p.558.
- [16] J.M. Payne & P.R. Jewell, "The Upgrade of the NRAO 8-beam Receiver," in *Multi-feed Systems for Radio Telescopes*, D.T. Emerson & J.M. Payne, Eds. San Francisco: ASP Conference Series, 1995, vol. 75, p.144.
- [17] "Response to Wireless Stimulation" in "Life Movements in Plants," pp. 418-424, published by the Bose Research Institute, Calcutta, 1919.
- [18] Wayne, R 1994. "The Excitability of Plant Cells: with a special emphasis on characean internodes" *Bot.Rev.*60, pp.265-367
- [19] Pickard, B, 1973: "Action Potentials in Higher Plants" *Bot.Rev.* 39, pp.172-201.
- [20] Virginia Shepherd (1998), University of New South Wales, private communication.