



PB137

POSITIVE VOLTAGE REGULATOR FOR BATTERY CHARGER

- REVERSE LEAKAGE CURRENT LESS THAN 10 μ A
- THREE TERMINAL FIXED VERSION (13.7V) OUTPUT CURRENT IN EXCESS OF 1.5A
- AVAILABLE IN $\pm 1\%$ (AC) SELECTION AT 25°C
- TYPICAL DROPOUT VOLTAGE 2V
- TEMPERATURE RANGE 0°C TO 150°C

DESCRIPTION

The PB137 is a positive voltage regulator able to provide 1.5A, at $V_{OUT}=13.7V$ and is intended as a charger for lead acid battery. The main feature is a reverse leakage current (Max 10 μ A at $T_J = 0$ to 40°C V_{IN} = floating and $V_{OUT} = 13.7V$). It is available in TO-220 and it employs internal current limiting, thermal shut-down and safe area protection, making it essentially indestructible. If adequate heat-sinking is provided, they can deliver over 1A output current.

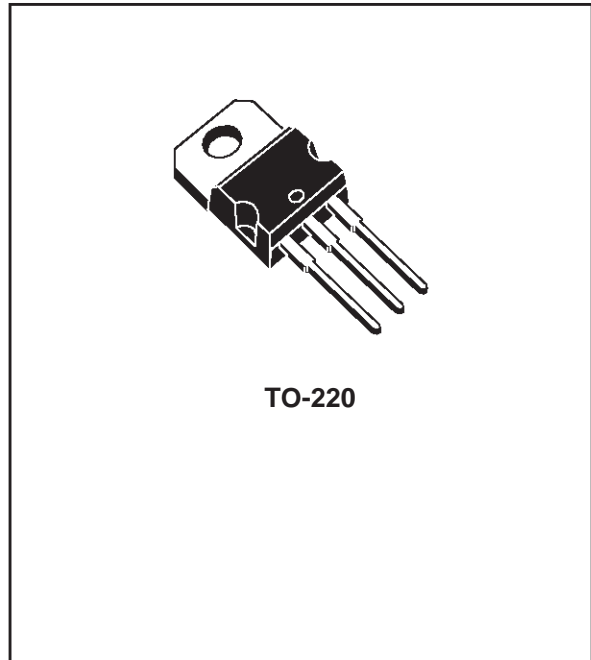

SCHEMATIC DIAGRAM

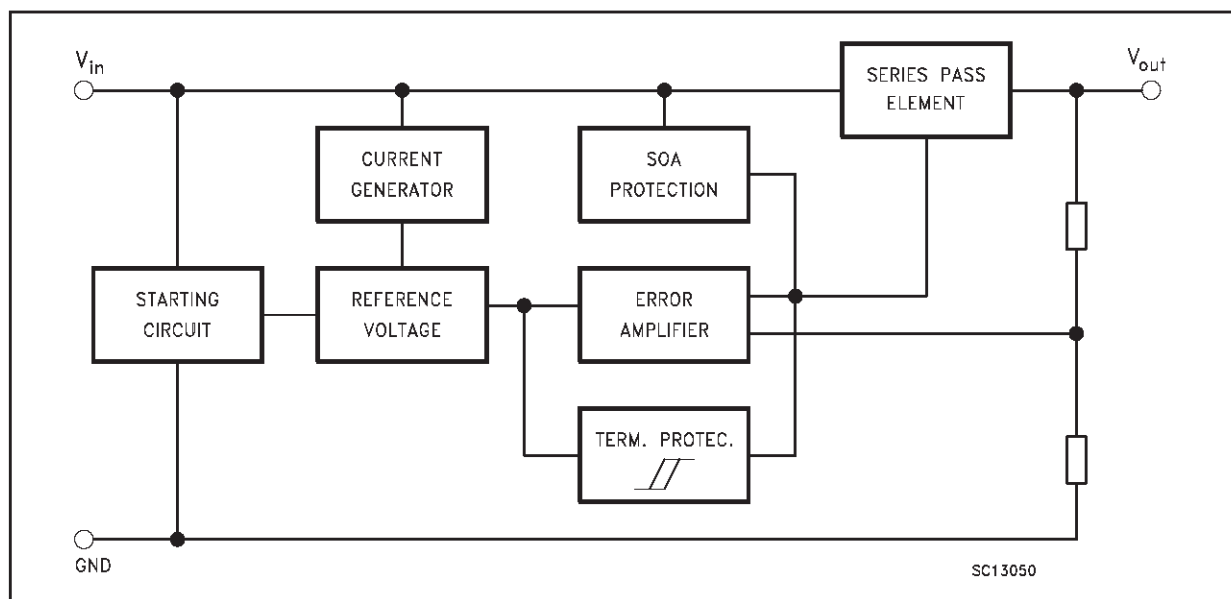

ABSOLUTE MAXIMUM RATINGS

| Symbol | Parameter | Value | Unit |
|-----------|--------------------------------------|--------------------|------|
| V_i | DC Input Voltage | 40 | V |
| I_o | Output Current | Internally limited | mA |
| P_{tot} | Power Dissipation | Internally limited | mW |
| T_{stg} | Storage Temperature Range | - 65 to 150 | °C |
| T_{op} | Operating Junction Temperature Range | 0 to 150 | °C |

Absolute Maximum Rating are those values beyond wick damage to the device may occur. Functional operation under these conditions is not implied.

THERMAL DATA

| Symbol | Parameter | Value | Unit |
|----------------|-------------------------------------|-------|------|
| $R_{thj-case}$ | Thermal Resistance Junction-case | 3 | °C/W |
| $R_{thj-amb}$ | Thermal Resistance Junction-ambient | 50 | °C/W |

CONNECTION DIAGRAM (top view)

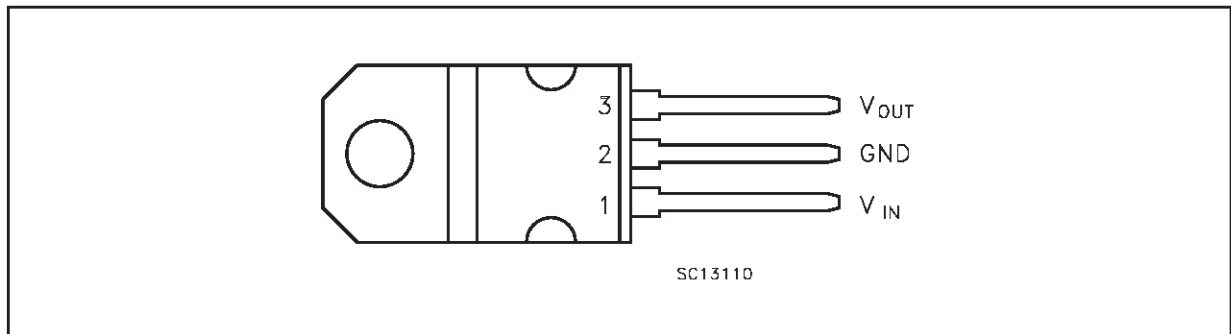

ORDERING NUMBERS

| Type | Output Voltage |
|----------|----------------|
| PB137ACV | 13.7 V |

APPLICATION CIRCUIT

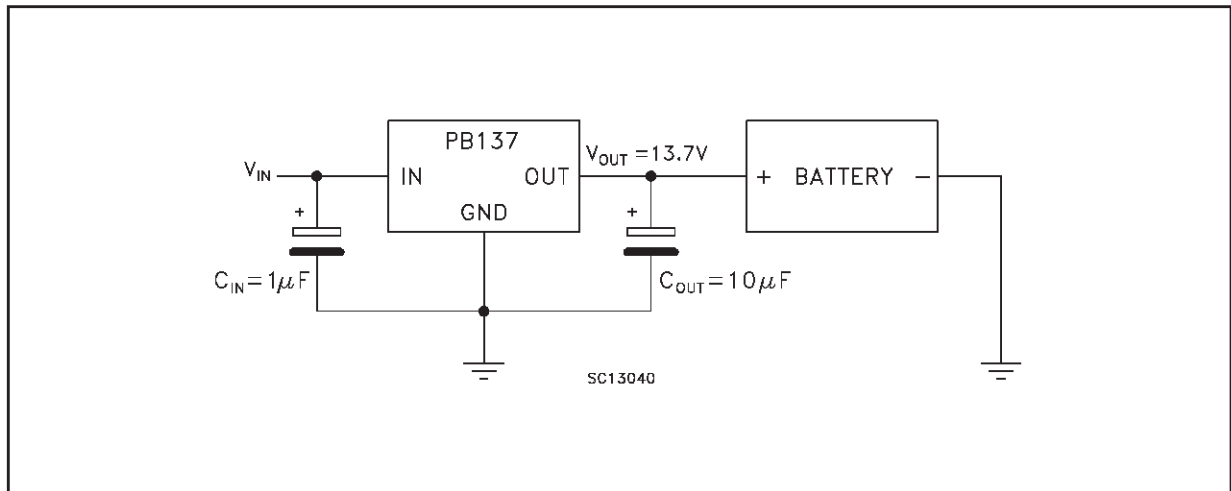

ELECTRICAL CHARACTERISTICS FOR PB137 (refer to the test circuits, $V_I = 18\text{ V}$, $I_{OUT} = 500\text{ mA}$, $T_j = 0\text{ to }150\text{ }^\circ\text{C}$, $C_{OUT} = 10\text{ }\mu\text{F}$ unless otherwise specified)

| Symbol | Parameter | Test Conditions | Min. | Typ. | Max. | Unit |
|--------------|---------------------------------|--|-------|------|-------|------------------|
| V_o | Output Voltage | $T_j = 25\text{ }^\circ\text{C}$ | 13.56 | 13.7 | 13.84 | V |
| | | | 13.43 | 13.7 | 13.97 | V |
| ΔV_o | Line Regulation | $V_i = 16\text{ to }28.7\text{ V}$, $T_j = 25\text{ }^\circ\text{C}$ | | 60 | 150 | mV |
| ΔV_o | Load Regulation | $I_o = 5\text{ to }1500\text{ mA}$, $T_j = 25\text{ }^\circ\text{C}$ | | 65 | 100 | mV |
| I_d | Quiescent Current | $T_j = 25\text{ }^\circ\text{C}$ | | 4 | 8 | mA |
| ΔI_d | Delta Quiescent Current vs Line | $V_i = 16\text{ to }28.7\text{ V}$ | | | 4 | mA |
| ΔI_d | Delta Quiescent Current vs Load | $I_o = 5\text{ to }1000\text{ mA}$ | | | 1.2 | mA |
| V_d | Dropout Voltage | $I_o = 1\text{ A}$, $T_j = 25\text{ }^\circ\text{C}$ | | 2.1 | 2.6 | V |
| I_{SC} | Short Circuit Current | $V_i - V_o = 5\text{ V}$, $T_j = 25\text{ }^\circ\text{C}$ | | 2.2 | | A |
| eN | Output Noise Voltage | $B = 10\text{ Hz to }10\text{ KHz}$, $T_j = 25\text{ }^\circ\text{C}$ | | 300 | | μVrms |
| SVR | Supply Voltage Rejection | $f = 120\text{ Hz}$, $T_j = 25\text{ }^\circ\text{C}$ | | 58 | | dB |
| I_{REV} | Reverse Leakage Current | $V_{OUT} = 13.7\text{ V}$, $V_{IN} = \text{floating}$, $T_j = 0\text{ to }40\text{ }^\circ\text{C}$ | | 0.1 | 10 | μA |
| S | Long Term Stability | $T_j = 125\text{ }^\circ\text{C}$, 1000hrs | | | 0.5 | % |

TYPICAL PERFORMANCE CHARACTERISTICS ($T_J=25^{\circ}\text{C}$)

Output Voltage vs Temperature

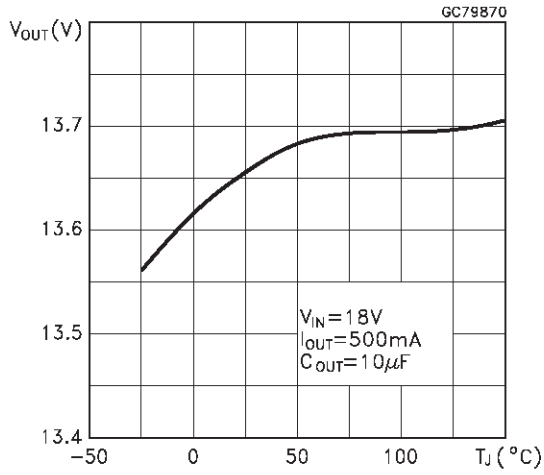

Output Voltage vs Input Voltage

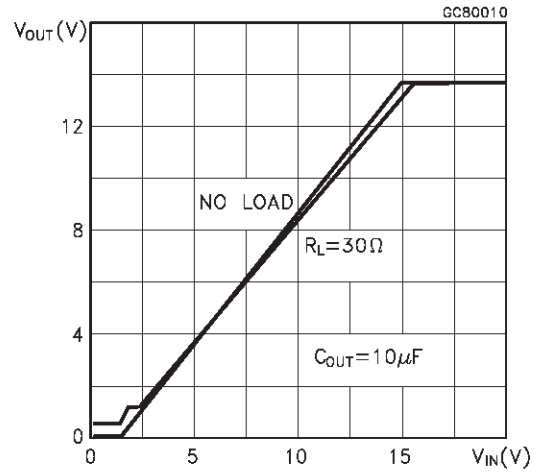

Output Voltage vs Output Current

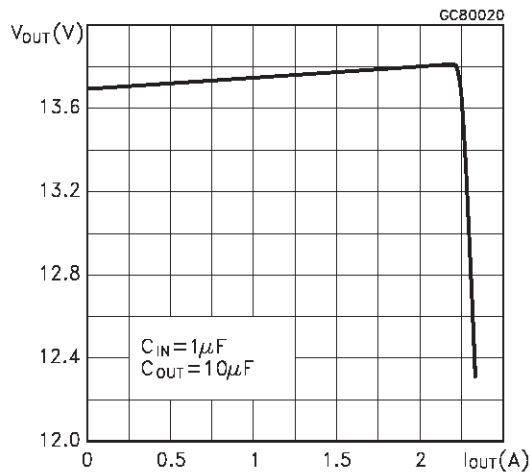

Load Regulation vs Temperature

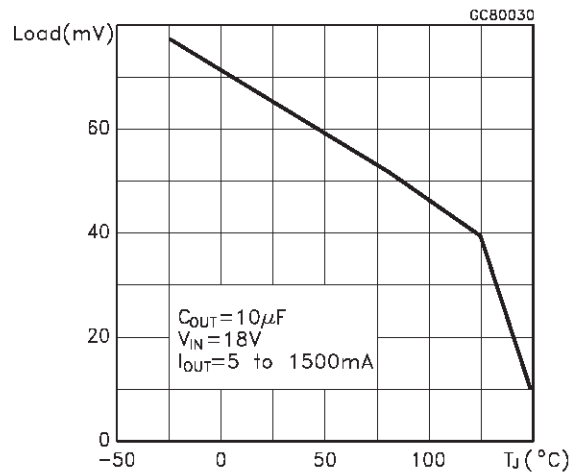

Line Regulation vs Temperature

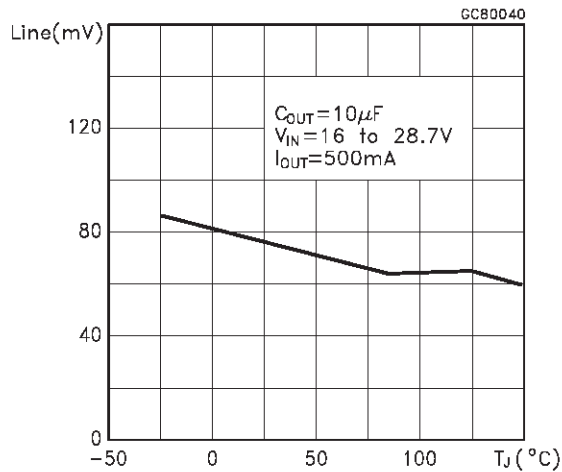

Dropout Voltage vs Temperature

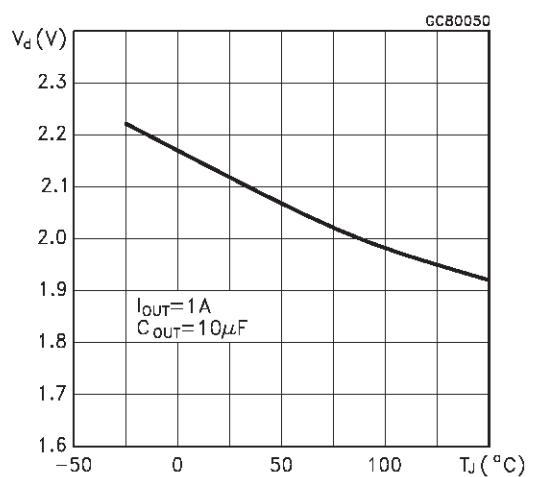

TYPICAL PERFORMANCE CHARACTERISTICS (continued)

Dropout Voltage vs Output Current

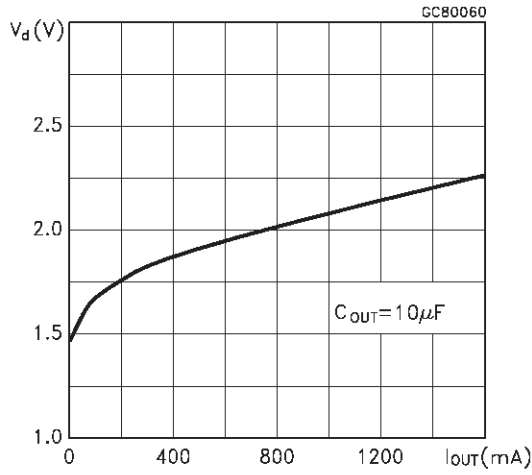

Short Circuit Current vs Dropout Voltage

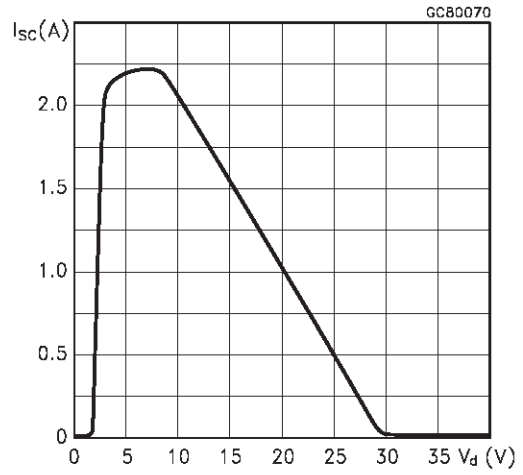

Short Circuit Current vs Temperature

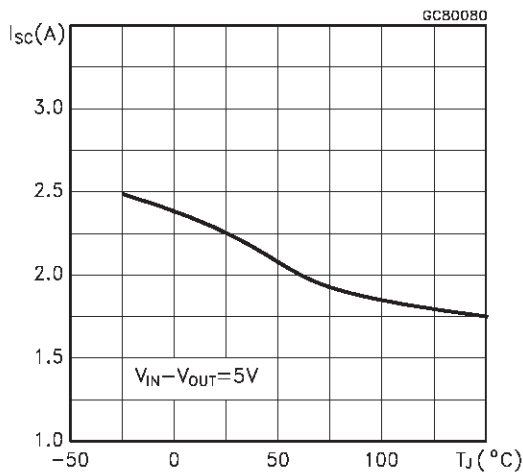

Reverse Leakage Current vs Temperature

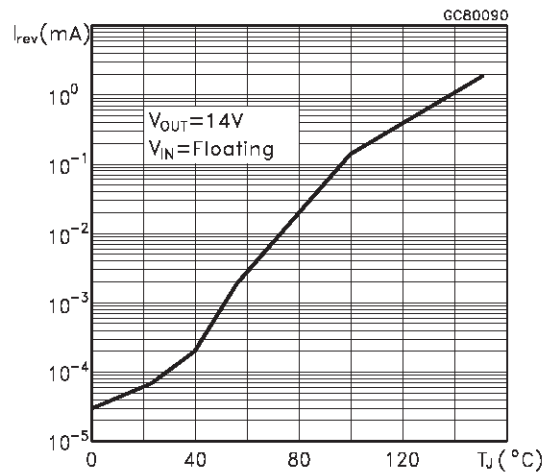

Quiescent Current vs Temperature

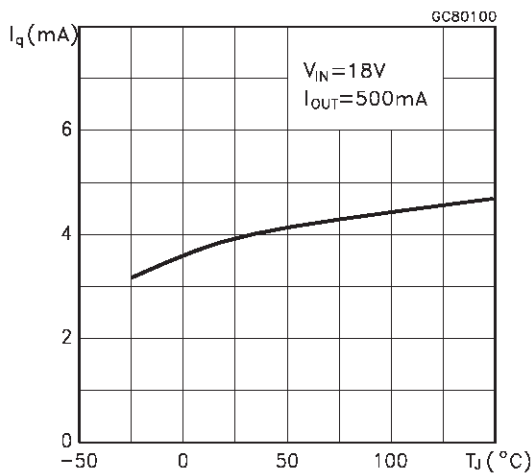

Quiescent Current vs Output Current

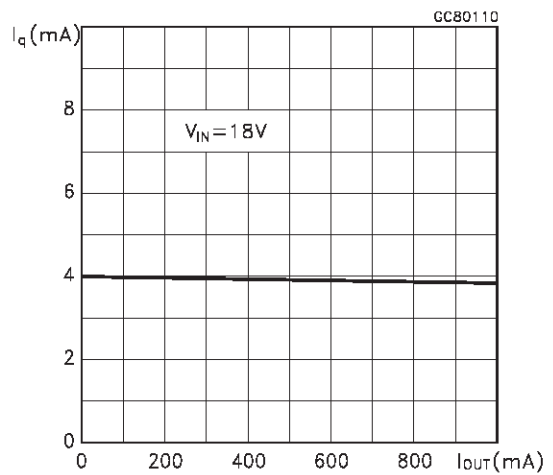

TYPICAL PERFORMANCE CHARACTERISTICS (continued)

Quiescent Current vs Input Voltage

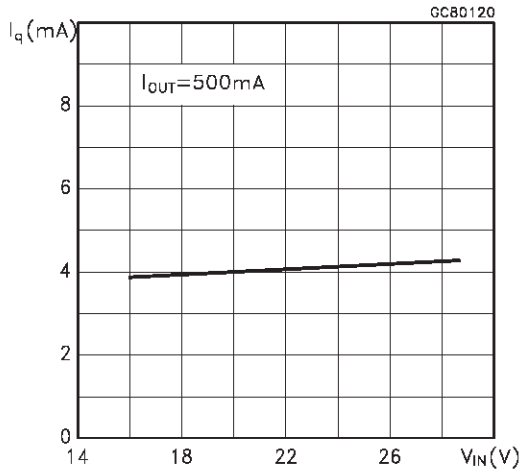

Thermal Protection

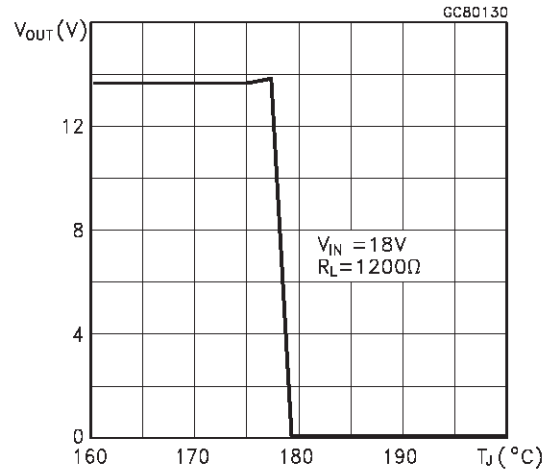

Supply Voltage Rejection vs Output Current

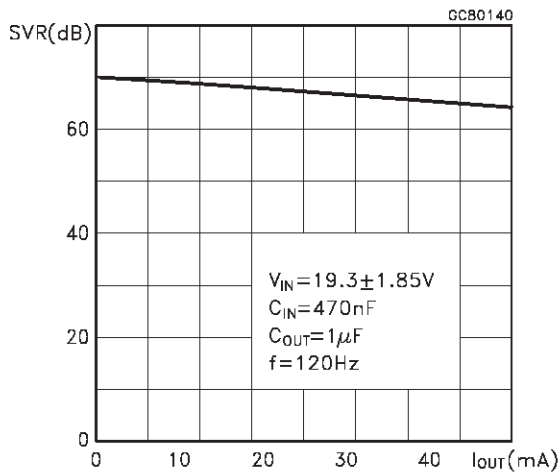

Supply Voltage Rejection vs Temperature

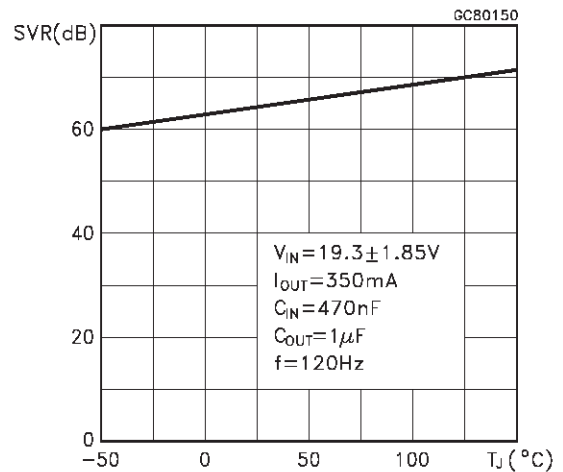

Line Transient Response

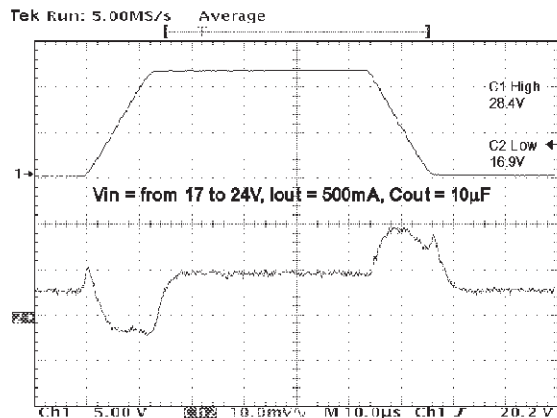

$V_{IN} = 17 \text{ to } 28.4\text{V}, I_{OUT} = 0.5\text{A}, C_{OUT} = 10\mu\text{F}$

Load Transient Response

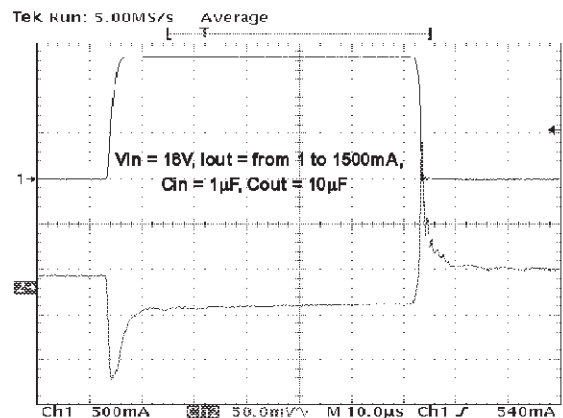

$V_{IN} = 18\text{V}, I_{OUT} = 5 \text{ to } 1.5\text{A}, C_{IN} = 1\mu\text{F}, C_{OUT} = 10\mu\text{F}$

TO-220 MECHANICAL DATA

| DIM. | mm | | | inch | | |
|------|-------|------|-------|-------|-------|-------|
| | MIN. | TYP. | MAX. | MIN. | TYP. | MAX. |
| A | 4.40 | | 4.60 | 0.173 | | 0.181 |
| C | 1.23 | | 1.32 | 0.048 | | 0.051 |
| D | 2.40 | | 2.72 | 0.094 | | 0.107 |
| D1 | | 1.27 | | | 0.050 | |
| E | 0.49 | | 0.70 | 0.019 | | 0.027 |
| F | 0.61 | | 0.88 | 0.024 | | 0.034 |
| F1 | 1.14 | | 1.70 | 0.044 | | 0.067 |
| F2 | 1.14 | | 1.70 | 0.044 | | 0.067 |
| G | 4.95 | | 5.15 | 0.194 | | 0.203 |
| G1 | 2.4 | | 2.7 | 0.094 | | 0.106 |
| H2 | 10.0 | | 10.40 | 0.393 | | 0.409 |
| L2 | | 16.4 | | | 0.645 | |
| L4 | 13.0 | | 14.0 | 0.511 | | 0.551 |
| L5 | 2.65 | | 2.95 | 0.104 | | 0.116 |
| L6 | 15.25 | | 15.75 | 0.600 | | 0.620 |
| L7 | 6.2 | | 6.6 | 0.244 | | 0.260 |
| L9 | 3.5 | | 3.93 | 0.137 | | 0.154 |
| DIA. | 3.75 | | 3.85 | 0.147 | | 0.151 |

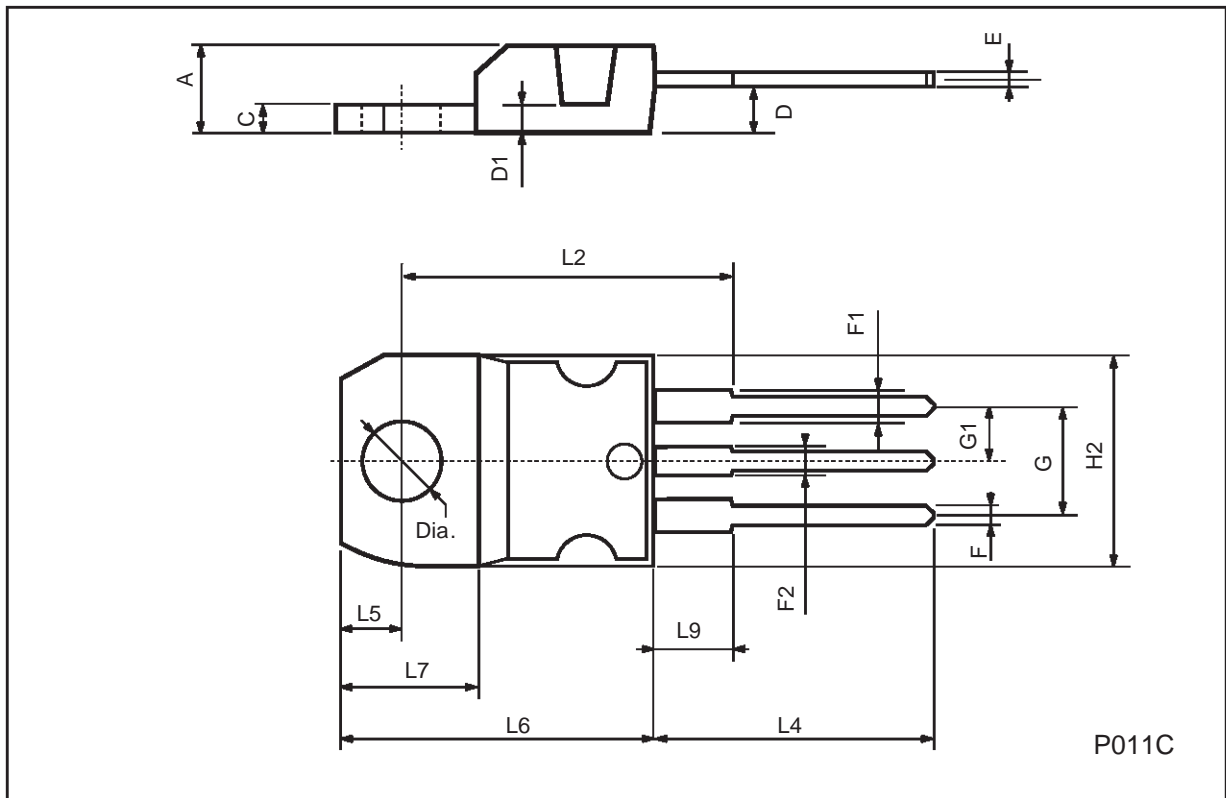

Information furnished is believed to be accurate and reliable. However, STMicroelectronics assumes no responsibility for the consequences of use of such information nor for any infringement of patents or other rights of third parties which may result from its use. No license is granted by implication or otherwise under any patent or patent rights of STMicroelectronics. Specification mentioned in this publication are subject to change without notice. This publication supersedes and replaces all information previously supplied. STMicroelectronics products are not authorized for use as critical components in life support devices or systems without express written approval of STMicroelectronics.

The ST logo is a registered trademark of STMicroelectronics

© 1998 STMicroelectronics – Printed in Italy – All Rights Reserved
STMicroelectronics GROUP OF COMPANIES

Australia - Brazil - Canada - China - France - Germany - Italy - Japan - Korea - Malaysia - Malta - Mexico - Morocco - The Netherlands -
Singapore - Spain - Sweden - Switzerland - Taiwan - Thailand - United Kingdom - U.S.A.

<http://www.st.com>

This datasheet has been download from:

www.datasheetcatalog.com

Datasheets for electronics components.