

## **RGM-3600 Operational Manual**

Version 1.2  
2008/05/02

This document contains information highly confidential to RoyalTek Company LTD (RoyalTek). It is provided for the sole purpose of the business discussions between supplier and RoyalTek and is covered under the terms of the applicable Non-Disclosure Agreements. Disclosure of this information to other parties is prohibited without the written consent of RoyalTek.

Prepared by RoyalTek Company LTD.

4F., No.188, Wen Hwa 2nd Rd., Kuei Shan,  
Tao Yuan 333, Taiwan

TEL: 886-3-3960001

FAX: 886-3-3960065

<http://www.royaltek.com/contact>

## Content

1.	Introduction .....	3
2.	RGM-3600 Picture .....	4
3.	RGM-3600 System Block Diagram.....	5
4.	RGM-3600 Technique Specification .....	6
5.	Mechanical Layout.....	10
6.	Software Specification and NMEA Protocol.....	11
7.	Package Specification and Order Information .....	17
8.	Revision History .....	22

## **RoyalTek GPS Receiver: RGM-3600 Operational Manual**

### **1. Introduction**

Congratulation on your purchase of RGM-3600, offering diverse GPS (Global Positioning System) applications. RGM-3600 represents the latest ingenious GPS technology from the leading GPS receiver manufacturer.

Connecting to the notebook PC or Handheld PC implementing map or navigation software, RGM-3600 helps you locate one or multiple objects, conduct personal & vehicle navigation, and/or apply for geographical surveys.

#### **Contents prepackaged with your RGM-3600 purchase:**

1. RGM-3600
2. Companion CD

#### **Product Features**

- 2 20 parallel channels.
- 2 -159 dBm high GPS sensitivity.
- 2 TCXO design.
- 2 NMEA-0183 compliant protocol/custom protocol.
- 2 Enhanced algorithm for navigation stability
- 2 SBAS (WAAS, EGNOS and MSAS) support and the default SBAS is enable
- 2 Lead-free
- 2 Backup battery (installed)

## 2. RGM-3600 Picture



### 3. RGM-3600 System Block Diagram

System block diagram description:

- a. Patch antenna with 1 Stage LNA
- b. 4Mega bits flash memory on chip
- c. 6pin I/O pin (pin 5, pin6 for internal)

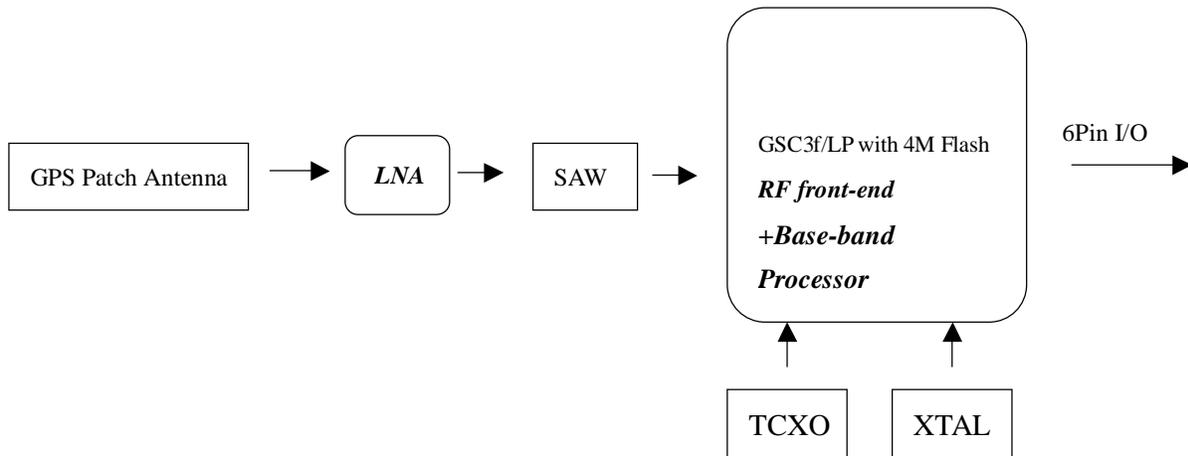

#### 4. RGM-3600LP Technique Specification

No	Function	Specification
<b>GPS receiver</b>		
1	Chipset	SiRF GSC3f/LP
2	Frequency	L1 1575.42MHz.
3	Code	C.A. Code.
4	Channels	20.
5	Chipset Sensitivity	-159dBm
6	Chipset cold start	35 sec @ open sky
7	Chipset warm start	35 sec @ open sky
8	Chipset hot start	1 sec @ open sky
9	Reacquisition	0.1sec typical
10	Position accuracy	10meters at 2D RMS.
11	Maximum altitude	18000 m
12	Maximum velocity	514 m/s
13	Trickle power mode	Duty cycle $\leq$ 34%. (Variable)
14	Update rate	Continuous operation: 1Hz
17	Testability	It shall be able to be tested by SiRF test mode IV and single channel simulator.
18	Protocol setup	It shall store the protocol setup in the SRAM memory.
<b>Interface Description</b>		
19	I/O Pin	6 Pin Pin1:RX Pin2:TX Pin3:GND Pin4:VCC Pin5:NC Pin6: BOOT
<b>Mechanical requirements</b>		
20	Dimension	(L)48.4 mm * (W)48.4 mm * (H)15.1mm $\pm$ 3mm
21	Weight	$\leq$ 30g
<b>Power consumption</b>		
22	Vcc	DC 5V $\pm$ 5%
23	Current	<b>TTL Version</b> Acquisition: 55mA (typical) Tracking: 50mA (typical) <b>RS-232 Version</b> Acquisition: 60mA (typical) Tracking: 55 mA (typical)

24	SRAM backup battery	3.3mAh Li-Ion rechargeable battery. Battery life at full charge is $\geq 7$ days.
<b>Environment</b>		
25	Operating temperature	-20 ~ +60°C
26	Storage temperature	-20 ~ +60°C
27	Humidity	$\leq 95\%$

### Hardware Interface

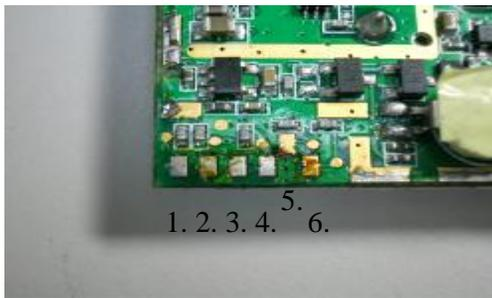

#### Module Interface Pin Number:

(VDD=2.85V $\pm$ 2%)

Pin #	Signal Name	I/O	Description	Characteristics
1	RX	I	UART	TTL: $V_{IH} \geq 0.7 * VDD$ $V_{IL} \leq 0.3 * VDD$ RS-232 $V_{IH} \geq 2.4V$ $V_{IL} \leq 0.6V$
2	TX	O	UART	TTL: $V_{OH} \geq 0.75 * VDD$ $V_{OL} \leq 0.25VDD$ RS-232 $V_{OH} \geq 5V$ $V_{OL} \leq -5V$
3	GND	G	System Power Ground	Reference Ground
4	VCC	I	System Power	VCC: 5V $\pm$ 5%
5	NC	NC		
6	Boot	I	Boot mode	$V_{IH} \geq 0.7 * VDD$ $V_{IL} \leq 0.3 * VDD$

- **VCC(5V DC power Input)**

This is the main DC power supply input pin. That provides voltage to the module.

- **GND**

GND provides the reference ground

• **RXA**

This is the main receiver channel and is used for receiving software commands to the board from SiRFDemo software or software written by users themselves.

PS: Pull up if not used.

• **TXA**

This is the main transmitting channel and is used for outputting navigation and measurement data for SiRFDemo software or software written by users themselves.

• **Boot**

Set this pin to high for programming flash.

**Cable connector**

- 6Pin Male PS2 RS-232 Interface Pin Number:

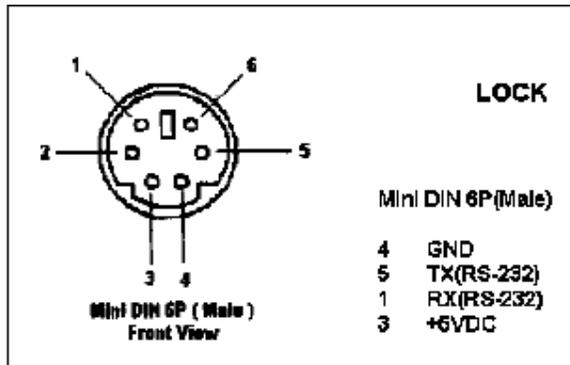

- 6Pin Male PS2 TTL Interface Pin Number:

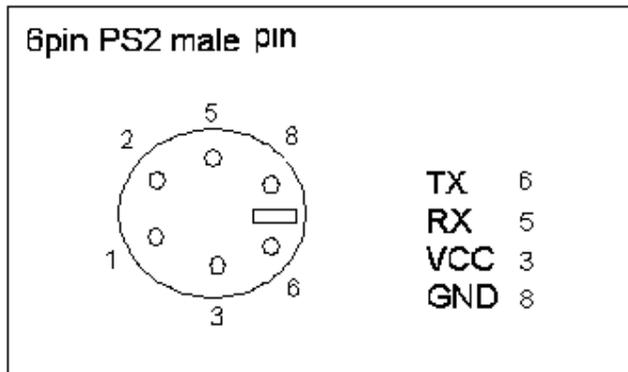



**- (Y cable) 9 pin D-SUB Interface Pin Number:**

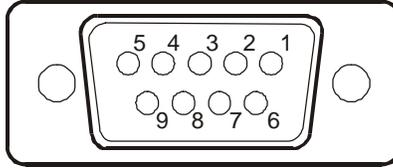

**Table 2**

Pin NO	Signal Name	I/O	Description	Characteristics
1	No connect			
2	TX	O	Serial Data Output	High: -3V ~ -15V Low: +3V ~ +15V
3	RX	I	Serial Data Input	High: -3V ~ -15V Low: +3V ~ +15V
4	No connect			
5	GND	G	Ground	
6	No connect			
7	No connect			
8	No connect			
9	No connect			

**- (Y cable) 6Pin Male PS2 Interface Pin Number:**

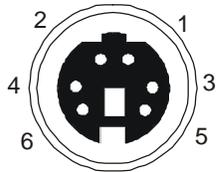

Pin #	Signal Name
1	NC
2	NC
3	GND
4	VCC
5	NC
6	NC

**- USB Interface Pin Number:**

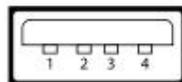

Pin #	Signal Name
1	$V_{bus}$ (4.75-5.25volts)
2	D-
3	D+
4	GND

## 5. Mechanical Layout

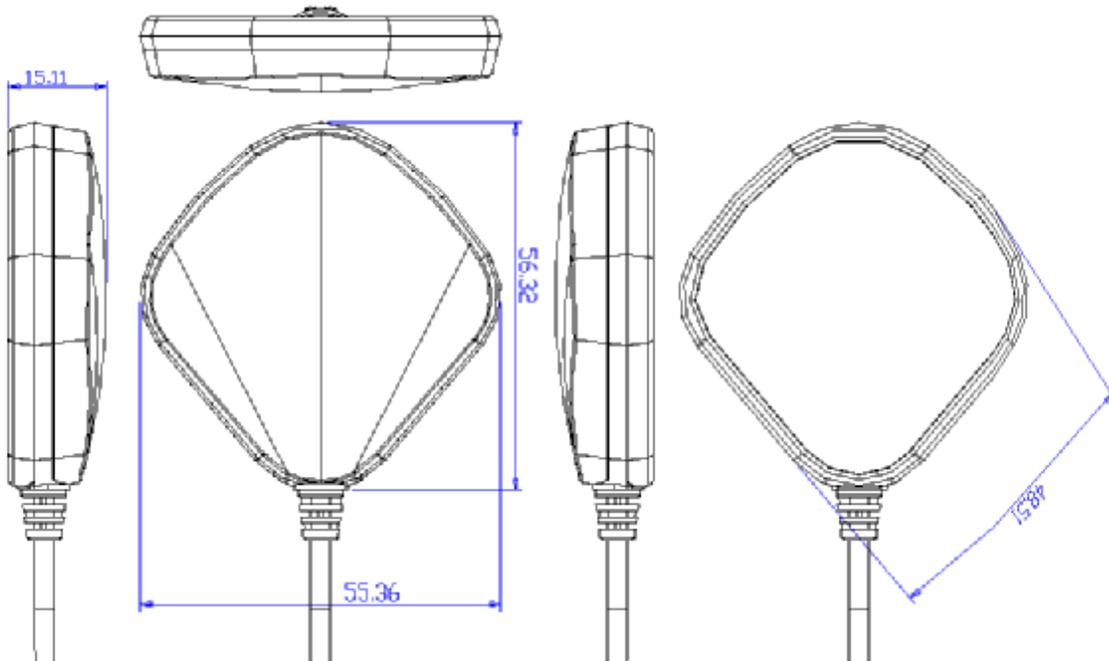

Unit : mm

## 6. Software Specification and NMEA Protocol

### Software Specification

GPS Firmware	[GSW3] GGA(1),GSA(1),GSV(5),RMC(1) 4800 GPS Firmware
GPS Utility	- A GPS performance diagnostic utility is required - C/NO, TTFF
WAAS	- Enable

### NMEA V3.0 Protocol

Its output signal level is TTL: 4800 bps (default), 8 bit data, 1 stop bit and no parity. It supports the following NMEA-0183

Messages: GGA, GLL, GSA, GSV, RMC and VTG.

NMEA Output Messages: the Engine board outputs the following messages as shown in Table 1:

Table 1 NMEA-0183 Output Messages

NMEA Record	Description
GGA	Global positioning system fixed data
GLL	Geographic position – latitude / longitude
GSA	GNSS DOP and active satellites
GSV	GNSS satellites in view
RMC	Recommended minimum specific GNSS data
VTG	Course over ground and ground speed

GGA-Global Positioning System Fixed Data

Table 2 contains the values of the following example:

\$GPGGA, 161229.487, 3723.2475, N, 12158.3416, W, 1, 07, 1.0, 9.0, M, , , ,0000\*18

Table 2 GGA Data Format

Name	Example	Units	Description
Message ID	\$GPGGA		GGA protocol header
UTC Position	161229.487		hhmmss.sss
Latitude	3723.2475		ddmm.mmmm
N/S Indicator	N		N=north or S=south
Longitude	12158.3416		Dddmm.mmmm
E/W Indicator	W		E=east or W=west

Position Fix Indicator	1		See Table 2-1
Satellites Used	07		Range 0 to 12
HDOP	1.0		Horizontal Dilution of Precision
MSL Altitude	9.0	meters	

Units	M	meters	
Geoid Separation		meters	
Units	M	meters	
Age of Diff. Corr.		second	Null fields when DGPS is not used
Diff. Ref. Station ID	0000		
Checksum	*18		
<CR> <LF>			End of message termination

*Table 3 Position Fix Indicators*

Value	Description
0	Fix not available or invalid
1	GPS SPS Mode, fix valid
2	Differential GPS, SPS Mode, fix valid
3	GPS PPS Mode, fix valid

GLL-Geographic Position –Latitude/Longitude

Table 3 contains the values of the following

Example: \$GPGLL, 3723.2475, N, 12158.3416, W, 161229.487, A\*2C

*Table 3 GLL Data Format*

Name	Example	Units	Description
Message ID	\$GPGLL		GLL protocol header
Latitude	3723.2475		ddmm.mmmm
N/S Indicator	N		N=north or S=south
Longitude	12158.3416		Dddmm.mmmm
E/W Indicator	W		E=east or W=west
UTC Position	161229.487		hhmmss.ss
Status	A		A=data valid or V=data not valid
Checksum	*2C		
<CR> <LF>			End of message termination

Table 4 contains the values of the following example:

\$GPGSA, A, 3, 07, 02, 26, 27, 09, 04, 15, , , , , 1.8,1.0,1.5\*33

Table 4 GSA Data Format

Name	Example	Units	Description
Message ID	\$GPGSA		GSA protocol header
Mode 1	A		See Table 4-2
Mode 2	3		See Table 4-1
Satellite Used	07		Sv on Channel 1
Satellite Used	02		Sv on Channel 2
....			....
Satellite Used			Sv on Channel 12
PDOP	1.8		Position Dilution of Precision
HDOP	1.0		Horizontal Dilution of Precision
VDOP	1.5		Vertical Dilution of Precision
Checksum	*33		
<CR> <LF>			End of message termination

Table 4-1 Mode 1

Value	Description
1	Fix not available
2	2D
3	3D

Table 4-2 Mode 2

Value	Description
M	Manual-forced to operate in 2D or 3D mode
A	Automatic-allowed to automatically switch 2D/3D

GSV-GNSS Satellites in View

Table 5 contains the values of the following example:

\$GPGSV, 2, 1, 07, 07, 79, 048, 42, 02, 51, 062, 43, 26, 36, 256, 42, 27, 27, 138, 42\*71\$GPGSV, 2, 2, 07, 09, 23, 313, 42, 04, 19, 159, 41, 15, 12, 041, 42\*41

Table 5 GGA Data Format

Name	Example	Units	Description
Message ID	\$GPGSV		GSV protocol header

Number of Messages <sup>1</sup>	2		Range 1 to 3
Messages Number <sup>1</sup>	1		Range 1 to 3
Satellites in View	07		
Satellite ID	07		Channel 1(Range 1 to 32)
Elevation	79	degrees	Channel 1(Maximum 90)
Azimuth	048	degrees	Channel 1(True, Range 0 to 359)
SNR (C/No)	42	dBHz	Range 0 to 99, null when not tracking
....			....
Satellite ID	27		Channel 4(Range 1 to 32)
Elevation	27	degrees	Channel 4(Maximum 90)
Azimuth	138	degrees	Channel 4(True, Range 0 to 359)
SNR (C/No)	42	dBHz	Range 0 to 99, null when not tracking
Checksum	*71		
<CR> <LF>			End of message termination

<sup>1</sup>Depending on the number of satellites tracked multiple messages of GSV data may be required.

RMC-Recommended Minimum Specific GNSS Data

Table 6 contains the values of the following example:

\$GPRMC, 161229.487, A, 3723.2475, N, 12158.3416, W, 0.13, 309.62, 120598, \*,10

Table 6 GGA Data Format

Name	Example	Units	Description
Message ID	\$GPRMC		RMC protocol header
UTC Position	161229.487		hhmmss.sss
Status	A		A=data valid or V=data not valid
Latitude	3723.2475		ddmm.mmmm
N/S Indicator	N		N=north or S=south
Longitude	12158.3416		dddmm.mmmm
E/W Indicator	W		E=east or W=west
Speed Over Ground	0.13	knots	
Course Over Ground	309.62	degrees	True
Date	120598		ddmmyy
Magnetic Variation		degrees	E=east or W=west

Checksum	*10		
<CR> <LF>			End of message termination

VTG-Course Over Ground and Ground Speed

Table 7 contains the values of the following example:

\$GPVTG, 309.62, T, , M, 0.13, N, 0.2, K\*6E

Table 7 VTG Data Format

Name	Example	Units	Description
Message ID	\$GPVTG		VTG protocol header
Course	309.62	degrees	Measured heading
Reference	T		True
Course		degrees	Measured heading
Reference	M		Magnetic
Speed	0.13	knots	Measured horizontal speed
Units	N		Knots
Speed	0.2	km/hr	Measured horizontal speed
Units	K		Kilometer per hour
Checksum	*6E		
<CR> <LF>			End of message termination

## **GPS Receiver User's Tip**

- A. GPS signals are affected by weather and environmental conditions. It is suggested to use the GPS receiver under less shielding environments to ensure GPS receiver has better receiving performance.
- B. When GPS receiver is in moving condition, it will prolong the time to fix the position. It is suggested to wait for the satellite signals to be locked at a fixed point when first power-on the GPS receiver before using.
- C. The following situations will affect the GPS receiving performance:
  - i. Solar control filmed windows.
  - ii. Metal shielded, such as umbrella, or in vehicle.
  - iii. Among high buildings.
  - iv. Under bridges and tunnels.
  - v. Under high voltage cables and near by radio wave sources, such as mobile phone base stations.
  - vi. Bad and heavy cloudy weather.
- D. If the satellite signals can not be locked or have encountered receiving problem (within the urban area), the following steps are suggested:
  - i. Plug the external active antenna into the GPS receiver and set the antenna outdoor or on the roof of the vehicle for better receiving..
  - ii. Move to another open space or reposition the GPS receiver towards the direction with fewer blockages.
  - iii. Move the GPS receiver away from sources of interference
  - iv. Wait until the weather condition has improved.
- E. With a backup battery, the GPS receiver can fix a position immediately at next power-on if the built-in backup battery is fully charged.



鼎天國際股份有限公司

## 7. Package Specification and Order Information

主體標籤貼附型式

標籤樣式 Label Specification

❶ 品名:主體標籤  
料號 3L0DNN08N3G  
依照製程控管序號編碼  
標準印製

7 碼外包 PO NUMBER

7 碼流水號

❷

表示法如下

Bar code	Bar code													
	1	2~7	8	9	10	11	12	13	14					
表示	製令代碼	外包 PO 後六碼	廠別	生產年	生產月	流水號								
內容	A	8	X	0	0	0	0	0	1					

Serial No 給予方法

- 製令代碼(0:正常製令,S: Sample making,R: Rework)
- 生產廠別"中環書均"是以 A 表示
- 生產年:西曆的末尾 1 位表示 例:2008 年以數字"8"表示
- 生產月:生產月表示 1 月是以 1、2 月是以 2、...、10 月是以 A、11 月是以 B、12 月是以 C 表示

❸ 品名: 止滑墊  
料號 3L0DNN21N6G

❸ 品名: 測試條碼標籤 34\*11mm  
P/N:3L034N08\*\*G  
序號條碼依照製程控管序號編碼標準印製

7 碼外包 PO NUMBER P+7 碼流水號

標籤貼附位置 Label Position

先貼主體標籤❶ 須依照定位標記貼附,上方再貼附置止滑墊❷

❸ 測試條碼標籤 (11x34 mm) : 貼附於流程卡上  
Printing is done prior to receiving the labels.

### 彩盒標籤貼附型式

#### 標籤樣式 Label Specification

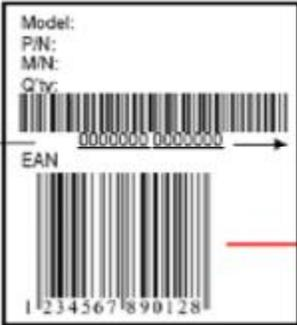

7碼外包 PO NUMBER

7碼流水號

表示法如下

		Bar code													
		1	2~7	8	9	10	11	12	13	14					
Bar code	製令	外	廠	生	生	流				水					
表示	代	包	別	產	產	水				號					
內容	碼	後	A	S	X	0	0	0	1						
	後	六													
	碼	碼													

Serial No 給予方法

- ① 製令代碼(0:正常製令,S: Sample making,R: Rework)
- ② 生產廠別:"中樞睿均"是以 A 表示
- ③ 生產年:西曆的末尾 1 位表示 例:2008 年以數字"8"表示
- ④ 生產月:生產月表示 1 月是以 1、2 月是以 2、...、10 月是以 A、11 月是以 B、12 月是以 C 表示

Name: Product Serial Number Label 序號標籤 45\*45mm  
 Number: 3L0ZKN08N9G  
 印製內容:序號條碼依照製程控管序號編碼標準印製  
 EAN 條碼,依據成品料號品名規格說明中有註明

#### 標籤貼附位置 Label Position

標籤 貼附於彩盒側邊留白處,如圖  
位置居中不得歪斜

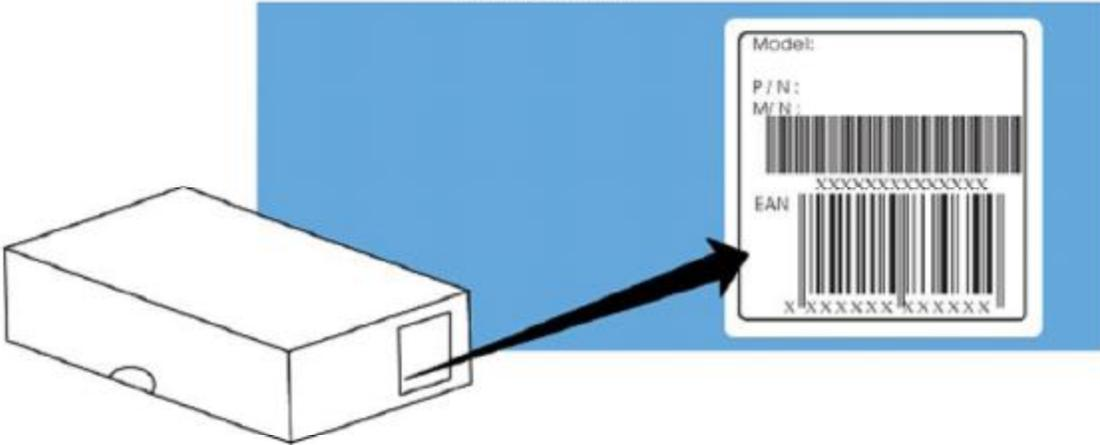

外箱標籤貼附型式

**標籤樣式 Label Specification**



1 碼固定碼 (C)+外包 PO 後七碼 +6 碼流水碼

**Serial No:**  
第一碼：固定碼 (C)  
第二至八碼：外包 PO 後七碼  
第九至十四碼：流水碼,表示法如下

	Bar code													
	1	2~8	9	10	11	12	13	14						
Bar code 表示	固定碼 C	外包 PO 後 7 碼	流水號											
內容	0	0	0	0	0	0	0	0	0	0	0	0	0	1

品名: 外箱序號標籤 30\*60mm  
料號: 3L060N08N7\*  
印刷內容: (依照製程控管序號編碼標準印製)

---

**標籤貼附位置 Label Position**

Packaging label should be applied to the upper right corner of the packaging box.

外箱序號標籤置於外箱右上角,但避開封箱膠帶貼附

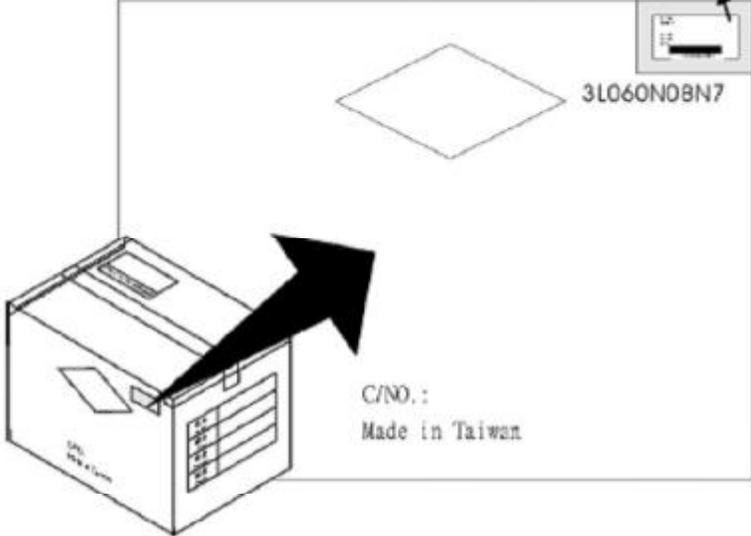

### 蜂巢包裝

項次	料號	品名
①	2B00YA10N5G	PE BAG
②	3H03PA44N9G	ISOLATION(V)
③	3H04PA44N0G	ISOLATION(H)
④	3H0A6A44N7G	ISOLATE(T)
⑤	3H0A6N23B1G	CONTAINER
⑥	5CJEN10000G	CD

SET01: 將 Isolation 隔板②片及 Isolation 隔板③片相互交叉組裝，並置於 Isolation-T 隔板④上

SET02: 主體放 PE 袋①對摺;包裝好的主體 2pcs 放入 Isolation 隔板之隔間裡，共裝 2 列 x8 行=32pcs./層

SET03: 一箱放置 5 層，共裝(4 列 x8 行)x5 層=160pcs./箱，最上方放置光碟⑥，如圖

Final: 再將外箱⑤蓋上並打包即完成包裝;如圖;標籤型式及貼附位置，請參照標籤規格書

外箱序號標籤置於外箱右上角，但避開封箱膠帶貼附

CND.:  
Made in Taiwan

### 彩盒包裝

項次	料號	品名
①	2B0UKN10N7G	PE BAG
②	3H09YN23N9G	CONTAINER
③	3H0DNN22N7G	GIFT BOX
④	3H0JNA44N2G	內襯摺紙板
⑤	3H0JNN44N1G	ISOLATE(T)
⑥	3S005N24N6G	SILICA GEL
⑦	5CJEN10000G	CD

主體

SET01: 主體置入 PE BAG ①中，線材不需要置入

項次 料號 品名

① 2B0UKN10N7G PE BAG

② 3H09YN23N9G CONTAINER

③ 3H0DNN22N7G GIFT BOX

④ 3H0JNA44N2G 內襯摺紙板

⑤ 3H0JNN44N1G ISOLATE(T)

⑥ 3S005N24N6G SILICA GEL

⑦ 5CJEN10000G CD

SET02: 將隔板 ④ 依摺痕組合;如圖

SET03: 主體放置於隔板 ④ 中間凹槽，主體線部分穿過隔板，放在隔板 ④ 下層，如圖示

SET03: 主體放置於隔板 ④ 中間凹槽，主體線部分穿過隔板，放在隔板 ④ 下層，如圖示

SET04: 乾燥劑 ⑥ 放在盒 ③ 下方，再將隔板 ④ 置入盒 ③，最上方放置光碟 ⑦，如圖

SET05: 包裝好的彩盒 ③ 放進外箱 ② 內，天地板 ⑤ 放置上中下三片，共裝 2 盒 x 2 盒 x 10 層=40 盒/箱

外箱序號標籤置於外箱左上角，用黏膠封鎖膠帶粘附

Final: 再將外箱 ② 蓋上並打包即完成包裝;如圖;標籤型式及貼附位置，請參照標籤規格書

鼎天國際股份有限公司

### 8. Revision History

Title	RGM-3600 GPS Receiver		
Doc Type	Operational Manual		
Revision Number	Date	Author	Change notice
1.0	2007/03/26	Amy.liu	Initial Release
1.1	2007/05/15	Amy.liu	Modify 4. RGM-3600LP Technique Specification - Chipset Sensitivity 、 cold start 、 warm start 、 hot start
1.2	2008/05/02	Amy.liu	Modify company's address 、 tel. 、 7. Package Specification and Order Information, add 4. RGM-3600LP Technique Specification cable connector type.

#### Contact Information Section

Contact: [sales@royaltek.com](mailto:sales@royaltek.com)

Headquarter:

Address: 4F., No.188, Wen Hwa 2nd Rd., Kuei Shan, Tao Yuan 333, Taiwan

TEL: 886-3-3960001

FAX: 886-3-3960065

Web Site: <http://www.royaltek.com>

Web Site Customer Service: <http://www.royaltek.com/contact>