



## Funk-Positionsschalter // RF 95

### Merkmale/Optionen

- Befestigungsmaße nach DIN EN 50 047
- Ausgangssignal individuell am Empfänger konfigurierbar
- EnOcean-Protokoll
- Datenrate 120 kbps

- Keine Energieversorgung, Verdrahtung und Leitungsverlegung erforderlich
- Multi-netzwerkfähig
- Einfache Programmierung auf der Empfängerseite
- Ex Version erhältlich  
[/Ex Funkpositionsschalter Ex RF 95](#)

### Maßzeichnung

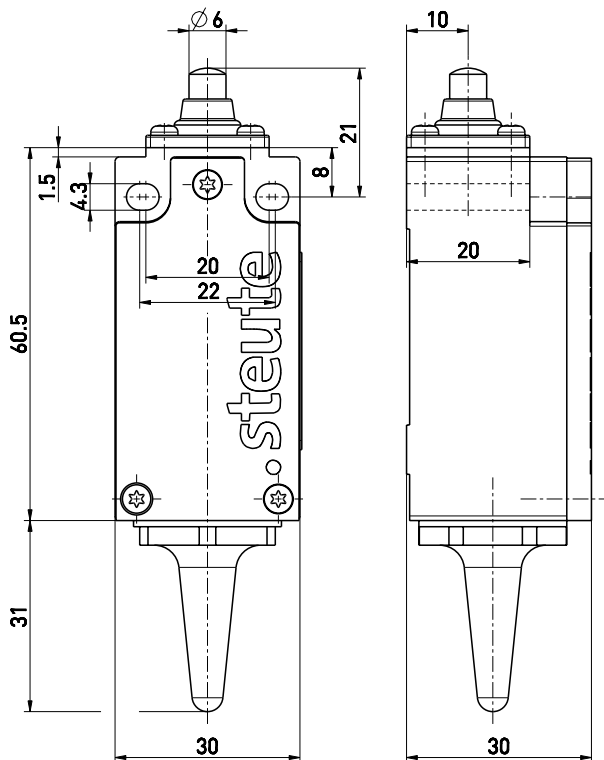

### Technische Daten

Vorschriften	EN 60947-5-1; EN 61000-6-2; EN 301 489-1; EN 301 489-3; EN 300 220-2
Gehäuse	glasfaserverstärkter, schlagfester Thermoplast, selbstverlöschend UL 94-V0
Deckel	glasfaserverstärkter, schlagfester Thermoplast, selbstverlöschend UL 94-V0
Schutzart	IP 67 nach IEC/EN 60529
Protokoll	EnOcean
Schaltfrequenz	ca. 9000 Telegramme mit Wiederholungen/h
Umgebungstemperatur	-20 °C ... +65 °C
Spannungsversorgung	Elektrodynamischer Energiegenerator
Frequenz	868,3 MHz
Sendeleistung	max. 10 mW
Datenrate	120 kbps
Kanalbandbreite	280 kHz
Reichweite	max. 300 m im Außenbereich, max. 30 m im Innenbereich
Mech. Lebensdauer	> 1 Million Schaltspiele
Betätigungsdauer	min. 80 ms
Hinweis	kein Statussignal
Prüfzeichen	

Irrtümer und technische Änderung vorbehalten.



## Funk-Positionsschalter // RF 95

### Bestelldaten

Stößel W

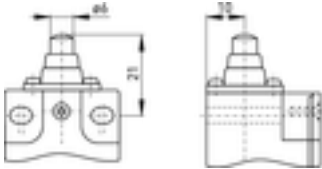

Typ  
RF 95 W EN868

Best.-Nr.  
95902901

Kappe WK

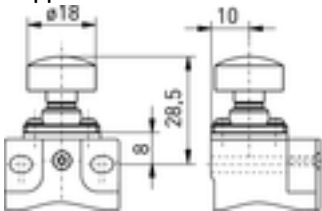

Typ  
RF 95 WK EN868

Best.-Nr.  
95902902

Rollenstößel R

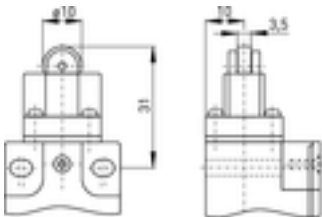

Typ  
RF 95 R EN868

Best.-Nr.  
95909901

Langer Rollenstößel RL

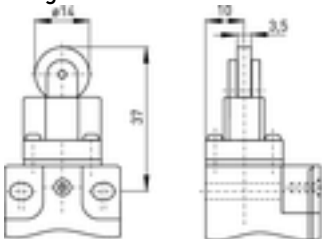

Typ  
RF 95 RL EN868

Best.-Nr.  
95911001

Kunststoff-Rollenhebel WH

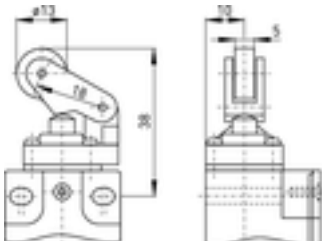

Typ  
RF 95 WH EN868

Best.-Nr.  
95914001



## Funk-Positionsschalter // RF 95

### Bestelldaten

Metall-Rollenhebel WHM

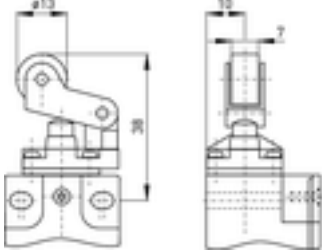

Typ  
RF 95 WHM EN868

Best.-Nr.  
95914902

Langer Metall-Rollenhebel WHLM

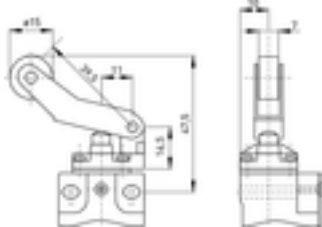

Typ  
RF 95 WHLM EN868

Best.-Nr.  
95916001

Kunststoff-Rollenhebel 4K

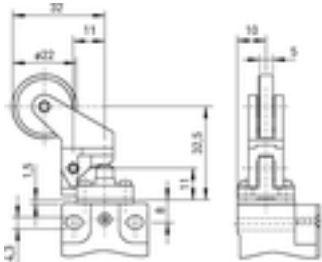

Typ  
RF 95 4K EN868

Best.-Nr.  
95964001

Kunststoff-Parallelhebel WPH

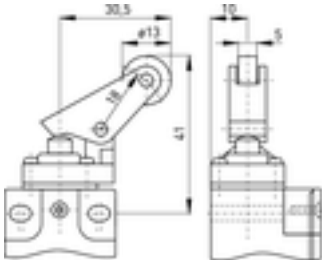

Typ  
RF 95 WPH EN868

Best.-Nr.  
95920002



## Funk-Positionsschalter // RF 95

### Bestelldaten

Metall-Parallelhebel WPHM

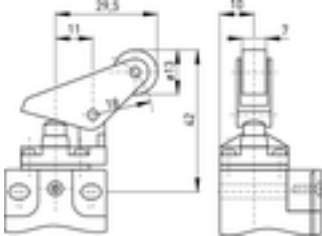

Typ  
RF 95 WPHM EN868

Best.-Nr.  
95920001

Kipphebel WHKM

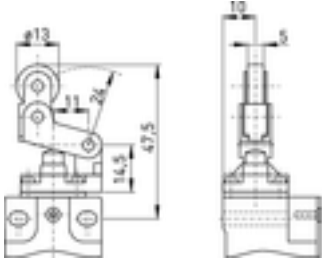

Typ  
RF 95 WHKM EN868

Best.-Nr.  
95918001

Drehhebel D

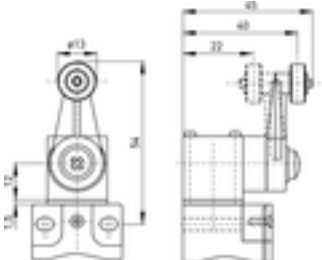

Typ  
RF 95 D EN868

Best.-Nr.  
95921901

Stellbarer Drehhebel DS

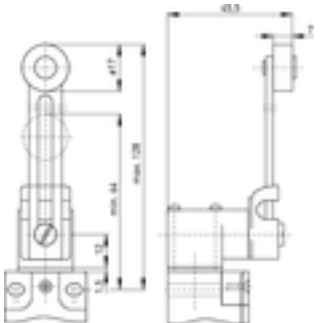

Typ  
RF 95 DS EN868

Best.-Nr.  
95929001



## Funk-Positionsschalter // RF 95

### Bestelldaten

Feder-Drehhebel DF

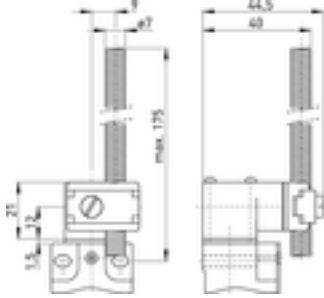

Typ  
RF 95 DF EN868

Best.-Nr.  
95927901

Draht-Drehhebel DD

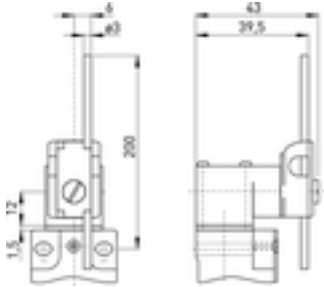

Typ  
RF 95 DD EN868

Best.-Nr.  
95925001

### Zubehör

Funkempfänger  
1 Wechslerkontakt, DC-Version



Typ  
RF Rx EN868-1W, 24 VDC

Best.-Nr.  
90590001



## Funk-Positionsschalter // RF 95

### Zubehör

Funkempfänger  
NPN-Ausgang, DC-Version



Typ  
RF Rx EN868-NPN, 24 VDC

Best.-Nr.  
90590002

Funkempfänger  
PNP-Ausgang, DC-Version



Typ  
RF Rx EN868-PNP, 24 VDC

Best.-Nr.  
90590003

Funkempfänger  
1 Wechslerkontakt, AC/DC-Version



Typ  
RF Rx EN868-1W, 24 VAC/DC

Best.-Nr.  
90590007



## Funk-Positionsschalter // RF 95

### Zubehör

Funkempfänger  
RF Rx EN868-2W-RS232

Typ  
RF Rx EN868-2W-RS232

Best.-Nr.  
90590008



Funkempfänger  
RF Rx EN868-2W

Typ  
RF Rx EN868-2W

Best.-Nr.  
90590012



Funkempfänger  
4 Wechsler

Typ  
RF Rx EN868-4W

Best.-Nr.  
90590006





## Funk-Positionsschalter // RF 95

### Zubehör

Funkrepeater



Typ  
RF RxT EN868-1K

Best.-Nr.  
90590004

Handsender R 101



Typ  
Handsender R 101

Best.-Nr.  
01.08.0282

Feldstärke Messgerät EPM 300



Typ  
Feldstärke Messgerät EPM 300

Best.-Nr.  
90598005





## Funk-Positionsschalter // RF 95

### Zubehör

Netzteil 24 V DC



Typ  
Netzteil 24V DC

Best.-Nr.  
90598012

RF Magnet-Antenne 868 MHz



Typ  
RF Magnet-Antenne 868 MHz 2,5 m

Best.-Nr.  
01.08.0386

RF SMA Antenneneinbaubuchse



Typ  
RF SMA Antenneneinbaubuchse 0,5 m

Best.-Nr.  
90598001

RF SMA Antennenverlängerung



Typ  
RF SMA Antennenverlängerung 3 m

Best.-Nr.  
90598002



## Funk-Positionsschalter // RF 95

### Zubehör

RF Sperrtopf-Antenne 868 MHz



Typ  
RF Sperrtopf-Antenne 868 MHz

Best.-Nr.  
90598003