

# System Multimeter PM2534

Operation Manual/Gebrauchsanleitung/Notice d'emploi

4822 872 30333  
860117

---

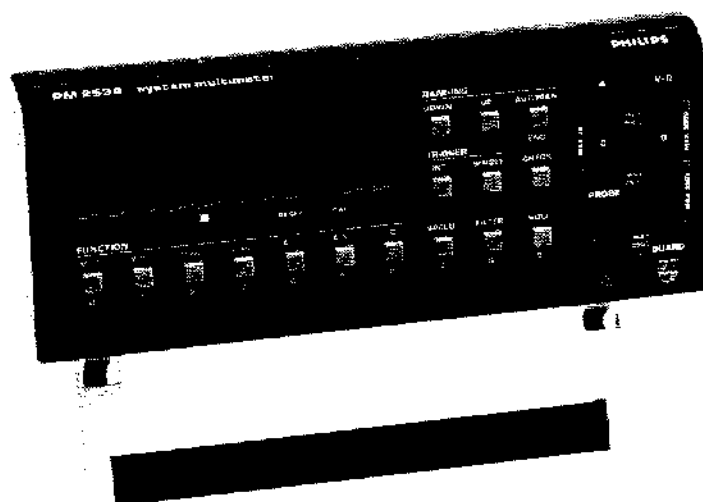

**PHILIPS**

## 2. GENERAL INFORMATION

### 2.1 INTRODUCTION

The PM2534 is a digital, automatic multimeter controlled by a microcomputer. The type of the microcomputer is a 8031 extended with a 16 k ROM. The instrument can perform the measurements as listed below.

- Direct voltages ( $V_{\text{DC}}$ )
- Alternating voltages ( $V_{\text{AC}}$ ) true RMS
- Direct currents ( $A_{\text{DC}}$ )
- Alternating currents ( $A_{\text{AC}}$ ) true RMS
- Resistance, in two-wire ( $\Omega$ -2 W) and four-wire ( $\Omega$ -4 W) configuration
- Temperature  $^{\circ}\text{C}$

Ranges can be selected manually, automatically or remote.

Beside the standard functions the user can alter the speed to increase the number of measurements per second, or to obtain a higher resolution.

The filter function switches in a frequency filter in the function  $V_{\text{AC}}$  and  $A_{\text{AC}}$ ; in all other functions (except  $^{\circ}\text{C}$ ) it acts as a digital filter.

Offset in the lowest dc range can be compensated by using the NULL function.

Measurements can be started with an internal, manual or external facility. External starting is possible via the external start input, or via the IEC/IEEE-bus interface.

All the above mentioned-functions are also selectable via the IEC-625/IEEE-488 interface.

The PM2534 is equipped with an internal guard, which is externally accessible. Therefore, very low levels in a noisy ambient can be measured with high accuracy.

### 2.2 CHARACTERISTICS

#### 2.2.1 Safety Characteristics

This apparatus has been designed and tested in accordance with Safety Class I requirements of IEC Publication 348, Safety Requirements for Electronic Measuring Apparatus and CSA 556B, and has been supplied in a safe condition.

This manual contains information and warnings which must be followed to ensure safe operation and to retain the instrument in a safe condition.

This instrument:

- satisfies the requirements of EEC Council Directive NO. 73/23 EEC in that it conforms with IEC Publication 348.
- is listed by the Canadian Standards Association as certified.
- is certified by the Independent German Testing and Approvals Institute VDE (and has been tested according to VDE 0411, Part 1).

**2.2.8 Temperature (°C)**

Measuring principle	Pt-100 probe, according to DIN 43760, in 4-wire configuration via PROBE input									
Recommended probe	Philips PM 9249 (-60 °C up to +200 °C)									
Range	-100 °C up to 850 °C									
Resolution	Speed 2: 0.1 °C Speed 3: 1 °C									
Measuring current	1 mA									
Linearisation	Probe characteristics according DIN 43760 is linearised within stated accuracy limits									
Accuracy	Excl. probe $\pm$ (0.3 % of reading + 0.2 °C)									
Temperature coefficient	$\pm$ (0.01 % of reading + 0.003 % range)/K									
Response time (excl. probe)	<table border="1" data-bbox="857 820 1377 937"> <thead> <tr> <th></th> <th>internal trig</th> <th>single trig</th> </tr> </thead> <tbody> <tr> <td>Speed 2</td> <td>&lt;750 ms</td> <td>&lt;550 ms</td> </tr> <tr> <td>Speed 3</td> <td>&lt;75 ms</td> <td>&lt;65 ms</td> </tr> </tbody> </table>		internal trig	single trig	Speed 2	<750 ms	<550 ms	Speed 3	<75 ms	<65 ms
	internal trig	single trig								
Speed 2	<750 ms	<550 ms								
Speed 3	<75 ms	<65 ms								
Max. voltage between "0" and guard	30 Vac or dc, 42 Vpeak									
Max. voltage at probe tip	Depending on probe									

**2.2.9 Converter characteristics (of analog-to-digital converter)**

Type of conversion	Linear
Operating principle	Integrating ADC
Commutation point	At the end of each representation unit
Basic mode of operation: - manually triggered - externally triggered	Via "SINGLE" pushbutton on front. In "SINGLE TRIGGER" mode via rear input "EXT TRIG" (BNC). Starting a measurement via the interface is possible in SINGLE TRIGGER mode.
- repetitive triggered	In "INT TRIGGER" mode a new measurement is started automatically after completing the previous one.
Range setting	Selectable between AUTO and MANUAL ranging - Manual with UP and DOWN switches - Automatic: . upranging at about 100 % of scale, 3 000/30 000/300 000/3 000 000 . downranging at about 9 % of scale, 270/2700/27 000/270 000
Polarity setting	Automatic setting on Vdc, Adc, °C. blanked in other functions

Resolution  
 1 : 3 000  
 1 : 30 000  
 1 : 300 000  
 1 : 3 000 000  
 depending on selected function, range and speed mode

Initial settings after power on or reset  
 V<sub>---</sub>, Auto ranging, Speed 2, Internal-trigger, Filter off, Null off

### 2.2.10 Time function

Input settling time

Automatically adapted to obtain a correct measuring result when input signal and trigger signal are given simultaneously in Single Trigger mode

Sampling time

Speed \ Version	50 Hz	60 Hz
1, 2, 3	20 ms	16 $\frac{2}{3}$ ms
4	2 ms	2 ms

### 2.2.11 Input terminal arrangement

Number of sockets

- 5x safe 4 mm terminal on removable input unit mounted in front; can also be mounted on rear (guard, 0 V- $\Omega$ , 0A, V- $\Omega$ , A).
- 2x 8 pin DIN connector for PROBE, one on front and one on rear. Only one socket accessible at a time.

Input configuration

Asymmetrical, floating, guarded

Impedance between sockets

guard - ground	>10 G $\Omega$ // <1000 pF
guard - "0"	>10 G $\Omega$ // <1000 pF
"0" - ground	>20 G $\Omega$ // < 500 pF
"0" - V- $\Omega$	depending on function and range, see relevant spec. points.
"0" - A	
"0V- $\Omega$ " - "0A"	directly connected

Maximum voltage between input sockets

guard - ground	250 Vac or dc, 350 Vpeak
guard - "0"	250 Vac or dc, 350 Vpeak
"0" - ground	250 Vac or dc, 350 Vpeak
V- $\Omega$ - ground	450 Vac or dc, 600 Vpeak
A - "0"	250 Vac or dc, 350 Vpeak fuse protected I <sub>max</sub> 3 A
V- $\Omega$ - "0"	depending on function and range; see relevant specification

## 2.3 OPERATIONAL DATA

Warm-up time	30 minutes to reach specified 90 days accuracy 2 hours before calibration and for 24 h specification
Safety	According to IEC-348/VDE 0411 Safety Class I CSA 556-B
Mechanical characteristics	Dimensions: 280 x 210 x 86 mm Mass: 2.85 kg. Cabinet material: Aluminium case plastic front
Recalibration interval	1 year
Back-up battery life-time	5 years

### 2.3.1 Display

#### Visual representation

Number of digits	6.5, 5.5, 4.5, 3.5, depending on function, range and speed mode	
Number of representation units	3 000 30 000 300 000 3 000 000	depending on function, range and speed mode
Means of representation of output value	7-segment, reflective LCD display, 9 mm	
Polarity representation	Automatic indication of + or - , or blanked according to measured quantity	
Decimal point representation	Indicated in LCD display	
Means of function representation	Selected function is indicated in LCD via units indication and annunciators	
Means of units representation	Via 16-segment characters in LCD; mV, V, $\Omega$ , k $\Omega$ , M $\Omega$ , $\mu$ A, mA, $^{\circ}$ C	
Overload representation	Display indicates "OL"	
Indication of exceeding crest-factor or clipping input circuit	"1" in LCD, measured value remains on display	
Data hold	Possible in SINGLE TRIGGER mode via "SINGLE" pushbutton or EXT TRIG input on rear, or by using Data Hold Probe PM9267	
Range hold	Possible via RANGING "AUT/MAN" switch	
Acoustic representation	Signal is given: - at Vdc and Vac when overload occurs on 300 V range (cannot be switched off) - at Adc and Aac when overload occurs on 3 A range (cannot be switched off)	

**2.3.2 IEC/IEEE interface**

IEC/IEEE interface According to IEC-625, IEEE-488  
See section 4.4. for specification

**2.3.3 System 21 interface**

Interface function Master function System 21 bus  
Connector type 9-pin female D-connector  
Available supply current 200 mA

**2.3.4 External control**

Remote programmable Via IEC/IEEE-bus  
External triggering Via BNC on rear  
- Trigger pulse negative-going, width  $> 15 \mu\text{s}$   
H = +2.4 ... +20 V  
L = -20 ... +1 V  
- By short-circuiting EXT TRIG input one measurement is performed.  
Recovery time  $> 10 \text{ ms}$   
- EXT TRIG input is protected up to 60 Vac or dc, 85 V<sub>peak</sub>

**2.4 ENVIRONMENTAL CONDITIONS****General**

The environmental data mentioned in this manual are based on the results of the manufacturer's checking procedures.  
Details on these procedures and failure criteria are supplied on request by the PHILIPS organisation in your country, or by PHILIPS, INDUSTRIAL & ELECTRO-ACOUSTICAL EQUIPMENT DIVISION, EINDHOVEN, THE NETHERLANDS.

Operating conditions are specified according to IEC 359.

**2.4.1 Climatic conditions**

Group I with extension of the temperature limits

**Temperature**

Reference temperature 23 °C  $\pm$  1 °C  
Rated range of use 0 °C ... 50 °C  
Limit range of operation 0 °C ... 55 °C  
Limit range of storage and transport -25 °C ... +70 °C

**Humidity**

Reference rel. hum. 45 - 75 % RH  
Rated range of use 20 - 80 % RH (no condensing)  
Limit range of operation 20 - 80 % RH  
Limit range of storage and transport 5 - 95 % RH  
Max. dew-point 25 °C

**Barometric pressure**

Rated range of use 70 kPa to 106 kPa (up to 2200 m)  
Limit range for storage and transport 53.3 kPa to 106 kPa (up to 4300 m)

**2.4.2 Mechanical conditions**

Group	2
-------	---

**2.4.3 Line supply conditions**

Group	S2
-------	----

**Voltage**

Reference value	230 V $\pm$ 1 %
Rated range of use	230 V $\pm$ 10 %

*Note: Instrument can be altered internally for a nominal mains voltage of 115 V.*

**Frequency**

Reference value	50 Hz $\pm$ 1 %
Rated range of use	50 Hz $\pm$ 1 %

*Note: Instrument can be altered internally for a nominal mains frequency of 60 Hz*

**Interruptions**

Interruption	<10 ms: no influence >10 <500 ms: instrument may either restart or continue >500 ms: instrument will restart, condition equals situation after switching on power
--------------	---

**2.4.4 Power consumption**

Power consumption	<20 VA
-------------------	--------

**Electromagnetic compatibility**

Conducted interference	CISPR publ 11 and 14 VDE 871-B and 875-K
------------------------	---

Radiated interference Susceptibility	VFG 1046/84 VFG 1046/84
---	----------------------------

**2.4.5 Accessories**

<b>Supplied with instrument:</b>	Measuring leads PM9266 (incl. probes) Mains supply cable Spare fuses Operating manual 8-pin DIN connector
----------------------------------	---

**Optionally available**

Specific accessories for PM2534	4-wire $\Omega$ cable	PM9264/01
	Shielded measuring cable	PM9265/01

**Universal accessories**

High frequency probe	PM9210
High frequency probe	PM9213
Current shunt	PM9244
Current transformer	PM9245
Current probe	PM9101
EHT probe	PM9246
Temp. probe (Pt-100)	PM9249
Data hold probe	PM9267
Rack mounting set	PM9280/02

### 2.2.2 Performance Characteristics

- Properties expressed in numerical values with stated tolerance are guaranteed by PHILIPS. Specified non-tolerance numerical values indicate those that could be **nominally** expected from the mean of a range of identical instruments.
- This specification is valid after the instrument has warmed up for 30 minutes (reference temperature 23 °C  $\pm$  2 °C) to reach the 90 days accuracy. The warm-up time to reach the 24 hours specification is 2 hours.

### 2.2.3 Vdc

Ranges 300 mV, 3 V, 30 V, 300 V

Measuring modes:

Speed mode	Measuring speed (depending on measured value)	Nominal scale length	Resolution on 300 mV range
Speed 1	0.2 up to 0.3 meas/s	3 000 000	100 nV
Speed 2	2 up to 3 meas/s	300 000	1 $\mu$ V
Speed 3	20 up to 30 meas/s	30 000	10 $\mu$ V
Speed 4	>100 meas/s	3 000	100 $\mu$ V

Notes: - stated measuring speed is excluding IEC/IEEE controller.

- At speed 1 display value will be updated within 0.5 s after a step-change of input signal

Accuracy is given in:

$\pm$ (% of reading + % of range) relative to calibration values

Speed mode	Range	Accuracy 24 h, tcal $\pm$ 1 °C	Accuracy 90 days, tcal $\pm$ 5 °C	Accuracy 1 year, tcal $\pm$ 5 °C
Speed 1 and 2	300 mV	0.0025 + 0.0013*	0.007 + 0.0017*	0.012 + 0.0017*
	3 V	0.0020 + 0.0010	0.005 + 0.0013	0.010 + 0.0013
	30 V	0.0025 + 0.0013	0.006 + 0.0017	0.015 + 0.0017
	300 V	0.0025 + 0.0010	0.006 + 0.0013	0.010 + 0.0013
Speed 3	300 mV - 300 V	0.0033 + 0.0033	0.008 + 0.005	0.010 + 0.005
Speed 4	300 mV - 300 V	0.033 + 0.033	0.04 + 0.05	0.05 + 0.05

\* valid when using "NULL".

Temperature coefficient in range outside: tcal  $\pm$  5 °C

$\pm$ (0.002 % of reading + 0.0005 % of range)/K

Input impedance:

10 M $\Omega$  // 30 pF  
at overload on 300 mV and 3 V ranges:  
100 k $\Omega$  // 30 pF

Offset current in input:

<30 pA



Clip indication

Signals clipping in input circuit during measuring cycle. Measuring cycle is normally finished and displayed including a warning symbol. "11"

Filter

Digital filter can be switched on/off via "FILTER" pushbutton. Filter characteristic: exponential with automatic reset after step change.

Zeroing

Offset voltage and thermal voltages on 300 mV range can be compensated via "NULL" pushbutton. Nulling range  $\pm 100 \mu\text{V}$ .

Maximum input voltage

Ranges 300 mV and 3 V: 400 V for  $< 30 \text{ s}$   
 300 V continuously  
 600 Vpeak  
 Ranges 30 V and 300 V: 400 V continuously  
 600 Vpeak  
 Max. allowable V·Hz product 10<sup>6</sup>

\* Ranging over max. number of ranges.

Speed 1	< 5.0 s	< 4.4 s	< 5.1 s	< 5.1 s	< 5.1 s
Speed 2	< 950 ms	< 540 ms	< 750 ms	< 800 ms	< 800 ms
Speed 3	< 100 ms	< 50 ms	< 210 ms	< 220 ms	< 220 ms
Speed 4	< 30 ms	< 15 ms	< 80 ms	< 80 ms	< 80 ms
	internal triggering	single triggering	internal triggering	single triggering	digits from final value
	excl. ranging		incl. ranging *		

Response time (Filter off): (at single trigger first reading is within specified distance from final value when step-input and trigger command are given simultaneously).

Max. CM voltage

250 Vac or dc, 350 Vpeak between "0" and guard  
 250 Vac or dc, 350 Vpeak between guard and ground

\* valid for 50 Hz or 60 Hz version respectively

Speed 1	> 140 dB	> 160 dB	> 140 dB
Speed 2	> 140 dB	> 150 dB	> 130 dB
Speed 3	> 140 dB	> 140 dB	> 120 dB
Speed 4	> 140 dB	> 80 dB	> 80 dB
	DC signal	50 or 60 Hz $\pm 0.1 \%$ *	50 or 60 Hz $\pm 1 \%$ *

Common Mode Rejection (measured with 1 k $\Omega$  unbalance, guard connected to CM voltage)

Max. SM signal

Peak value 140 % of range

\* valid for 50 Hz or 60 Hz version respectively

Speed 1	> 80 dB	> 60 dB
Speed 2	> 70 dB	> 50 dB
Speed 3	> 60 dB	> 40 dB
Speed 4	0	0
	50 or 60 Hz $\pm 0.1 \%$ *	50 or 60 Hz $\pm 1 \%$ *

Series Mode Rejection

## 2.2.4 Vac

Converter type	AC-coupled RMS
Ranges	300 mV, 3 V, 30 V, 300 V
Frequency range	Filter on 40 Hz - 100 kHz (default) Filter off 400 Hz - 100 kHz

Measuring modes:

Speed mode	Measuring speed (int trig) (depending on measured value)	Nominal scale length	Resolution on 300 mV range
Speed 2	2.2 up to 3 meas/s	30 000	10 $\mu$ V
Speed 3	20 up to 30 meas/s	3 000	100 $\mu$ V

Accuracy is:

Valid over 1-100 % of range;  
 $\pm$  (% of reading + % of range) relative  
to calibrated values

Speed 2 and 3	Frequency range	Accuracy 24 h, $t_{cal} \pm 1$ °C	Accuracy 90 days, $t_{cal} \pm 5$ °C	Accuracy 1 year, $t_{cal} \pm 5$ °C
Filter on Filter off	40 Hz - 5 kHz	0.1 + 0.1	0.2 + 0.1	0.3 + 0.1
	400 Hz - 5 kHz	0.1 + 0.1	0.2 + 0.1	0.3 + 0.1
Filter on and off	5 kHz - 100 kHz	0.02 + 0.02	0.04 + 0.02	0.06 + 0.02

Temperature coefficient in range outside  
 $t_{cal} \pm 5$  °C $\pm 0.03$  % of reading/K

Input impedance

Ranges 300 mV and 3 V: 1.2 M $\Omega$  // 30 pF  
Ranges 30 V and 300 V: 0.93 M $\Omega$  // 30 pFCommon Mode Rejection  
(guard connected to "0"  
1 k $\Omega$  unbalance)120 dB for dc signals  
80 dB for ac signals of 50 Hz,  
decreasing with 20 dB/dec

Maximum CM voltage

250 Vac or dc, 350 V<sub>peak</sub> between "0" and guard  
250 Vac or dc, 350 V<sub>peak</sub> between guard and groundResponse time: (at single trigger first reading is within specified distance from final value when step-input  
and trigger command are given simultaneously).

	Excl. ranging				Incl. ranging				Digits from final value
	Filter on		Filter off		Filter on		Filter off		
	Trigger		Trigger		Trigger		Trigger		
	internal	single	internal	single	internal	single	internal	single	
Speed 2	<1.8 s	<1.5 s	<1.1 s	<650 ms	<2.1 s	<3.1 s	<1.3 s	<1.5 s	10
Speed 3	<0.9 s	<1.0 s	<200 ms	<200 ms	<1.7 s	<2.7 s	<800 ms	<900 ms	10

Crest factor	>3.3 at full scale, increasing down scale by $3.3 \times \frac{\text{full scale}}{\text{reading}}$ with maximum of 33.  Warning on display when clipping occurs, by symbol "1"
Maximum input voltage	All ranges 400 Vac or dc, 600 Vpeak.
Maximum V.Hz	product $10^7$
Maximum dc voltage on input	400 V

### 2.2.5 Resistance (2-wire, 4-wire)

Input configuration	2-wire via "0" and "V-Ohm" 4-wire via PROBE
Ranges 2-wire	3 k $\Omega$ , 30 k $\Omega$ , 300 k $\Omega$ , 3 M $\Omega$ , 30 M $\Omega$ , 300 M $\Omega$ .
4-wire	3 k $\Omega$ , 30 k $\Omega$ , 300 k $\Omega$ , 3 M $\Omega$ .

Measuring modes:

Speed mode	Ranges	Measuring speed (depending on measured value)	Nominal scale length	Resolution
Speed 1	3 k $\Omega$ -3 M $\Omega$ 30 M $\Omega$ 300 M $\Omega$	.2 up to .3 meas/s .2 up to .3 meas/s .2 up to .3 meas/s	3 000 000 300 000 30 000	1 m $\Omega$ - 1 $\Omega$ 100 $\Omega$ 10 k $\Omega$
Speed 2	3 k $\Omega$ -3 M $\Omega$ 30 M $\Omega$ 300 M $\Omega$	2 up to 3 meas/s 2 up to 3 meas/s 2 up to 3 meas/s	300 000 30 000 3 000	10 m $\Omega$ - 10 $\Omega$ 1 k $\Omega$ 100 k $\Omega$
Speed 3	3 k $\Omega$ -3 M $\Omega$ 30 M $\Omega$ 300 M $\Omega$	20 up to 30 meas/s 20 up to 30 meas/s 20 up to 30 meas/s	30 000 3 000 300	100 m $\Omega$ - 100 $\Omega$ 10 k $\Omega$ 1 M $\Omega$
Speed 4	3 k $\Omega$ -300 k $\Omega$	>65 meas/s	3 000	1 $\Omega$ - 100 $\Omega$

Notes: - Stated measuring speed is excluding IEC/IEEE controller.  
- At Speed 1 display value will be updated within 0.5 s after a step-change of input signal.

Accuracy is given in:  $\pm$  (% of reading + % of range) relative to calibration values

Speed mode	Range	Accuracy 24 h, tcal $\pm 1$ $^{\circ}$ C	Accuracy 90 days, tcal $\pm 5$ $^{\circ}$ C	Accuracy 1 year, tcal $\pm 5$ $^{\circ}$ C
Speed 1, 2 and 3	3 k $\Omega$ - 300 k $\Omega$ 3 M $\Omega$ 30 M $\Omega$ 300 M $\Omega$	0.01 + 0.0033 0.02 + 0.0033 0.06 + 0.0033 0.8 + 0.033	0.02 + 0.0033 0.04 + 0.0033 0.10 + 0.0033 1.6 + 0.033	0.03 + 0.0033 0.05 + 0.0033 0.15 + 0.0033 2.0 + 0.033
Speed 4	3 k $\Omega$ -300 k $\Omega$	0.0033 + 0.033	0.05 + 0.033	0.06 + 0.033

Temperature coefficient in range outside:  
 $t_{cal} \pm 5 \text{ }^\circ\text{C}$

Ranges 3 k $\Omega$  - 3 M $\Omega$   
 30 M $\Omega$   
 300 M $\Omega$

$\pm 0.005 \%$  of reading/K  
 $\pm 0.02 \%$  of reading/K  
 $\pm 0.05 \%$  of reading/K

Measuring current

1 mA at 3 k $\Omega$  down to 10 nA at  
 300 M $\Omega$  (non-linear)

Maximum lead resistance in  
 4-wire configuration

100  $\Omega$

Maximum voltage at open input

<10 V

Polarity input sockets

"V- $\Omega$ " negative, "0" positive

Testing semiconductor junctions

Possible in forward (up to  $V_f = 3 \text{ V}$ ) and  
 reverse direction

Protection

2-wire terminals: up to 250 Vac or dc, 350 Vpeak  
 4-wire terminals: up to 30 Vac or dc, 42 Vpeak

Common Mode voltage influence  
 (measured with "guard" and "0" connected to CM voltage)

Speed	DC signal	50 or 60 Hz $\pm 0.1 \%$	50 or 60 Hz $\pm 1 \%$
1, 2, 3	0.00002	0.00002	0.0002
4	0.002	0.01	0.01

Maximum CM voltage:

- 2-wire configuration

250 Vac or dc, 350 Vpeak between "0" and guard  
 250 Vac or dc, 350 Vpeak between guard  
 and ground

- 4-wire configuration

30 Vac or dc, 42 Vpeak between "0" and  
 ground; guard must be connected to "0"

Response time: (filter off)

(at single trigger first reading is within specified distance from final value when step-input  
 and trigger command are given simultaneously)

Speed Mode	Ranges	Excl. ranging		Incl. ranging		Digits from final value
		internal trigger	single trigger	internal trigger	single trigger	
Speed 1	3 k $\Omega$ - 3 M $\Omega$	<5.0 s	<4.4 s	<5.2 s	<5.2 s	50
	30 M $\Omega$	<5.2 s	<4.6 s	<5.6 s	<5.8 s	50
	300 M $\Omega$	<5.5 s	<4.9 s	<5.8 s	<6.0 s	50
Speed 2	3 k $\Omega$ - 3 M $\Omega$	<950 ms	<540 ms	<750 ms	<800 ms	10
	30 M $\Omega$	<1.3 s	<700 ms	<1.1 s	<1.2 s	10
	300 M $\Omega$	<2.0 s	<1.0 s	<1.3 s	<1.4 s	10
Speed 3	3 k $\Omega$ - 3 M $\Omega$	<110 ms	<60 ms	<220 ms	<230 ms	10
	30 M $\Omega$	<140 ms	<90 ms	<500 ms	<500 ms	10
	300 M $\Omega$	<300 ms	<300 ms	<1.0 s	<1.0 s	10
	300 M $\Omega$	<500 ms	<500 ms	<1.5 s	<1.5 s	10
Speed 4	3 k $\Omega$ - 300 k $\Omega$	<40 ms	<25 ms	<90 ms	<90 ms	5

Filter	Digital filter can be switched on/off via "FILTER" pushbutton. Filter characteristic: exponential with automatic reset after step change
Clip indication	Signals clipping in input circuit during measuring cycle. Measuring cycle is normally finished and displayed including a warning symbol "1"

2.2.6 I<sub>dc</sub>

Ranges 30 mA, 3 A

Measuring modes:

Speed mode	Measuring speed (depending on measured value)	Nominal scale length	Resolution on 30 mA range
Speed 2	2 up to 3 meas/s	300 000	100 nA
Speed 3	20 up to 30 meas/s	30 000	1 μA
Speed 4	>100 meas/s	3 000	10 μA

Note: - stated measuring speed is excluding IEC/IEEE controller.

Accuracy is given in: ± (% of reading + % of range) relative to calibration values

Speed mode	Range	Accuracy 24 h, tcal ± 1 °C	Accuracy 90 days, tcal ± 5 °C	Accuracy 1 year, tcal ± 5 °C
Speed 2 and 3	30 mA and 3 A	0.01 + 0.003 0.1 + 0.01	0.03 + 0.003 0.15 + 0.01	0.05 + 0.003 0.2 + 0.01
	<1 A >1 A			
Speed 4	30 mA and 3 A	0.01 + 0.03 0.1 + 0.05	0.03 + 0.03 0.15 + 0.05	0.05 + 0.03 0.2 + 0.05
	<1 A >1 A			

Temperature coefficient outside range tcal ± 5 °C ± (0.005 % of reading + 0.001 % of range)/K

Voltage drop Range 30 mA <250 mV  
Range 3 A <600 mV

Protection By fuse 3.15 AF  
Up to 250 Vac or dc, 350 Vpeak.

Series Mode Rejection

	Mains frequency	
	50 or 60 Hz ± 0.1 % *	50 or 60 Hz ± 1 % *
Speed 2	>70 dB	>50 dB
Speed 3	>60 dB	>40 dB
Speed 4	0	0

\* valid for 50 Hz or 60 Hz version respectively

Max. SM signal

Peak value 150 % of range

Common Mode voltage  
influence $\pm$  (% of range/V)

	DC signals	50 or 60 Hz $\pm 0.1$ % *	50 or 60 Hz $\pm 1$ % *
Speed 2, 3	0.00002	0.00002	0.0002
Speed 4	0.002	0.01	0.01

\* valid for 50 Hz or 60 Hz respectively

Max CM voltage

250 Vac or dc, 350 Vpeak between "0" and guard  
250 Vac or dc, 350 Vpeak between guard and  
groundResponse time: (at single trigger first reading is within specified distance from final value when step-input  
and trigger command are given simultaneously)

	excl. ranging		incl. ranging		Digits
	internal trigger	single trigger	internal trigger	single trigger	from final value
Speed 2	<950 ms	<540 ms	<750 ms	<800 ms	10
Speed 3	<100 ms	<50 ms	<210 ms	<220 ms	10
Speed 4	<30 ms	<15 ms	<80 ms	<80 ms	5

Filter

Digital filter can be switched on/off via "FILTER"  
pushbutton.  
Filter characteristic exponential with automatic reset  
at step change

Clip indication

Signals clipping in input circuit during measuring  
cycle.  
Measuring cycle is normally finished and displayed  
including a warning symbol "!"**2.2.7 Iac**

Converter type

AC-coupled RMS, no DC component allowed.

Ranges

30 mA, 3 A

Frequency range

Filter on: 40 Hz - 1 kHz (default)  
Filter off: 400 Hz - 1 kHz

Measuring modes:

Speed mode	Measuring speed (int trig) (depending on measured value)	Nominal scale length	Resolution on 30 mA range
Speed 2	2.2 up to 3 meas/s	30 000	1 $\mu$ A
Speed 3	20 up to 30 meas/s	3 000	10 $\mu$ A

Accuracy is:

Valid over 1-100 % of range;  
 $\pm$  (% of reading + % of range) relative to  
 calibrated values

Speed 2 and 3	Frequency range	Accuracy 24 h, tcal $\pm 1$ °C	Accuracy 90 days, tcal $\pm 5$ °C	Accuracy 1 year, tcal $\pm 5$ °C
Filter on	40 Hz - 1 kHz	0.1 + 0.1	0.2 + 0.1	0.3 + 0.1
Filter off	400 Hz - 1 kHz	0.1 + 0.1	0.2 + 0.1	0.3 + 0.1

Temperature coefficient in range outside  
 tcal  $\pm 5$  °C

 $\pm 0.03$  % of reading/K

Voltage drop

Range 30 mA < 250 mV  
 Range 3 A < 600 mV

Protection

By fuse 3.15 AF  
 Up to 250 Vac or dc, 350 Vpeak

Common Mode voltage  
 influence

$\pm 0.0001$  % of range/V for DC signals  
 $\pm 0.0001$  % of range/V for AC signals up to 100 Hz

Maximum CM voltage

250 Vac or dc, 350 Vpeak between "0" and guard  
 250 Vac or dc, 350 Vpeak between guard and  
 ground

Response time: (filter off)

(at single trigger first reading is within specified distance from final value when step-input  
 and trigger command are given simultaneously)

	Excl. ranging				Incl. ranging				Digits from final value
	Filter on		Filter off		Filter on		Filter off		
	Trigger		Trigger		Trigger		Trigger		
	internal	single	internal	single	internal	single	internal	single	
Speed 2	<1.8 s	<1.5 s	<1.1 s	<650 ms	<2.1 s	<3.1 s	<1.3 s	<1.5 s	10
Speed 3	<0.9 s	<1.0 s	<200 ms	<200 ms	<1.7 s	<2.7 s	<800 ms	<900 ms	10

Crest-factor

>3.3 at full scale, increasing down scale by  
 $3.3 \times \frac{\text{full scale}}{\text{reading}}$   
 with maximum of 33.

Warning on display when clipping occurs, by  
 symbol "\*\*\*\*"

### 3. INSTALLATION INSTRUCTIONS

#### 3.1 INITIAL INSPECTION

Check the contents of the shipment for completeness and note whether any damage has occurred during transport. If the contents are incomplete, or there is damage, a claim should be filed with the carrier immediately, and the Philips Sales or Service organisation should be notified in order to facilitate the repair or replacement of the instrument.

#### 3.2 SAFETY INSTRUCTIONS

##### 3.2.1 Earthing (Grounding)

Before any other connection is made, the instrument shall be connected to a protective earth conductor via the three-core mains cable.

The mains plug shall be inserted only into a socket outlet provided with a protective earth contact. The protective action shall not be negated by use of an extension cord without protective conductor.

**WARNING:** Any interruption of the protective conductor inside or outside the instrument, or disconnection of the protective earth terminal, is likely to make the instrument dangerous. Intentional interruption is prohibited.

##### 3.2.2 Mains voltage setting and fuses

**WARNING:** The instrument shall be disconnected from all voltage sources when a fuse is to be renewed, or when the instrument is to be adapted to a different mains voltage.

- Before inserting the mains plug into the mains socket, make sure that the instrument is set to the local mains voltage.

*Note: If the mains plug has to be adapted to the local situation it should only be done by a qualified person.*

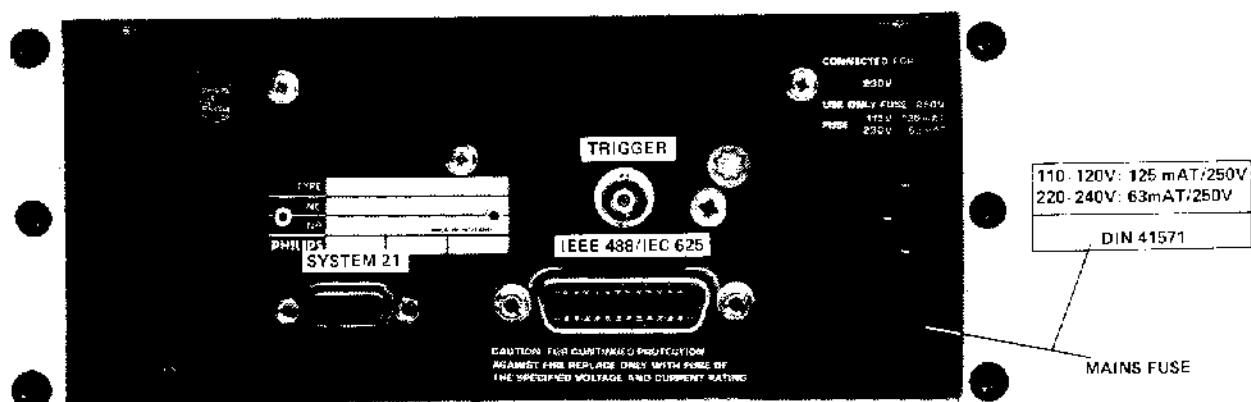

Figure 3.1 Mains fuse location



- The instrument shall be set to the local mains voltage only by a qualified person who is aware of the hazards involved.
- Make sure that only fuses of the required current rating, and specified type are used for renewal. The use of repaired fuses, and/or the short-circuiting of fuse holders, is prohibited.
- Fuses shall only be renewed by a qualified person who is aware of the hazard involved.

#### Mains voltage

When despatched from the factory, the PM2534 is set to the local mains voltage of 230 V/50 Hz. For modification to 115 V, or for modification to 60 Hz refer to the service manual of this instrument.

#### Mains fuse

The mains fuse is located in a holder on the rear panel, adjacent to the mains socket. To replace it, first remove the mains cable and prise out the lift-out lug with a screwdriver.

### 3.3 OPERATING POSITION OF THE INSTRUMENT

- The instrument may not only be used in horizontal position, but can also be used in a sloping position by folding down the handle. The characteristics mentioned in section 2.2 are guaranteed for both positions.
- Do not position the instrument on any surface which produces or radiates heat, or in direct sunlight.

### 3.4 19-INCH RACK-MOUNTING

The PM9280/02 is a rack-mounting set for mounting two instruments (e.g. 2x PM2534) into a 19-inch rack. If a PM2534 has to be built-in, the feet of the PM2534 must be removed. The instrument can be mounted in the rack and fastened with the screws, delivered with the rack-mounting set. (The holes of the PM2534, without the feet correspond to the holes (A) in the rack).

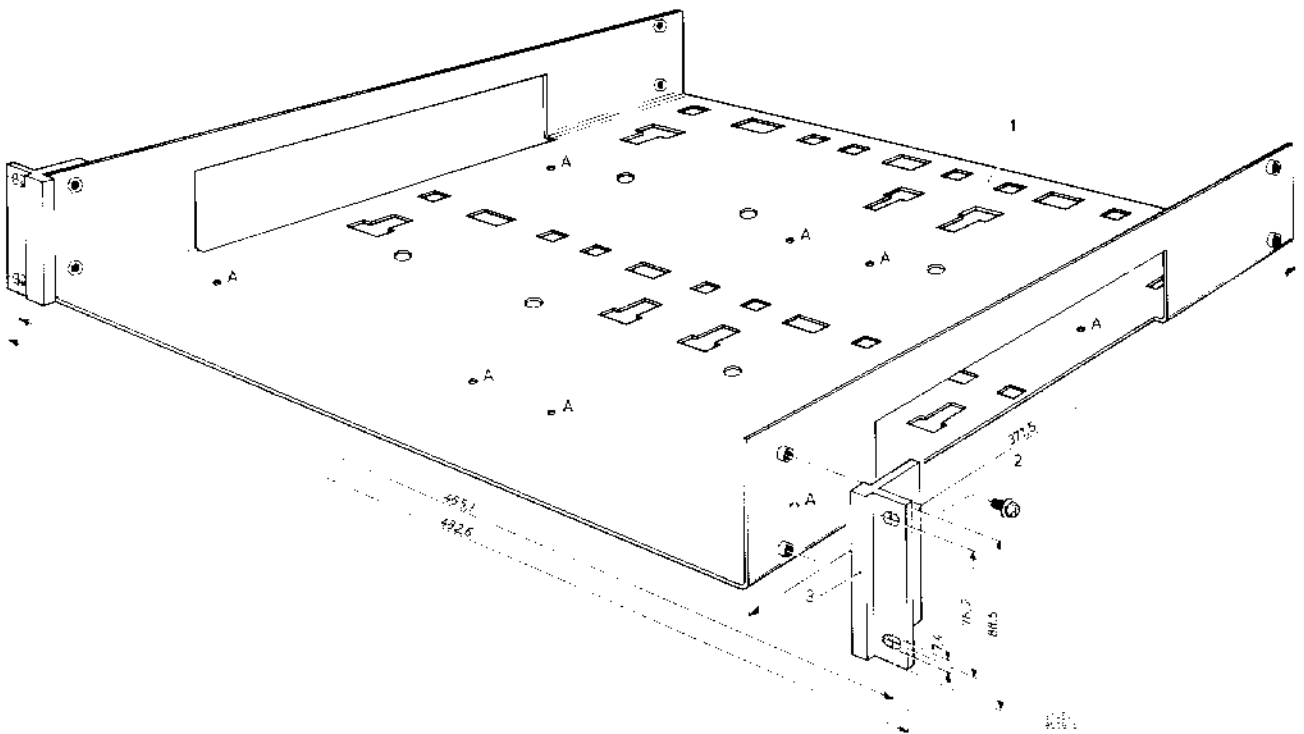

## 4. OPERATING INSTRUCTIONS

### 4.1 GENERAL INFORMATION

This section outlines the procedures and precautions necessary for operation.

It is subdivided into three main parts viz:

- Manual operation (local) of the PM2534

This part identifies and briefly describes the functions of the front and rear panel controls and indicators. It also explains the practical aspects of operation to enable an operator to evaluate quickly the instrument's main functions.

- Operation via a IEEE controller (Remote)

This section describes how to operate the instrument in a IEEE-488/IEC-625 configuration via a controller. It gives a detailed description of the functions, input and output data.

- Operation in combination with System 21

This section describes the practical use of the PM2534, in which the master function of System 21 is already included.

### 4.2 SWITCHING-ON

The instrument may be switched "ON" after making sure that the installation instructions, described in section 3 have been followed.

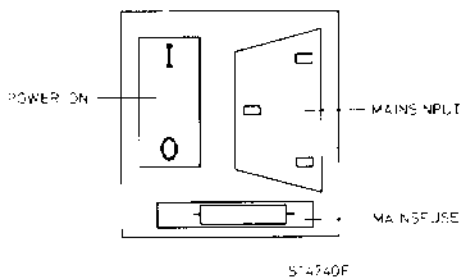

Having switched on, the PM2534 is immediately ready for use. After a warming-up time of 30 minutes the instrument meets the specifications listed in section 2 (90 days specification).

*Note: To meet the specifications use a shielded low thermal voltage cable. Recommended cable: PM9265/01*

The initial states after Power On:



Function :  $V_{DC}$   
 Range : Automatic  
 Speed : 2  
 Trigger : Internal  
 Filter : Off  
 Null : Off

### 4.3 MANUAL OPERATION

#### 4.3.1 General information

This section describes the functions of the PM2534 that can be controlled and operated by hand.

The input signals have to be supplied to the V- $\Omega$ , A,  $\theta$ , GUARD and PROBE sockets.

The first part describes the front panel controls such as display, keyboard and inputs.

In the second part of this section the specific modes such as: Ranging, Triggering, Speed, Filter and Null are described. These modes can be used in several main functions.

In the third part of this section the measuring of the different main functions such as  $V_{DC}$ ,  $V_{AC}$ ,  $\Omega$ -2w etc. are described.

#### 4.3.3.7 Check/end

The CHECK pushbutton enables, the several IEC/IEEE-bus parameters to be set. Also with this function a service test can be selected. Setting a parameter or selecting a test must be terminated with the END button.

For setting these IEC-625/IEEE-488 parameters see also section 4.3.3. To select a test, refer to the service manual.

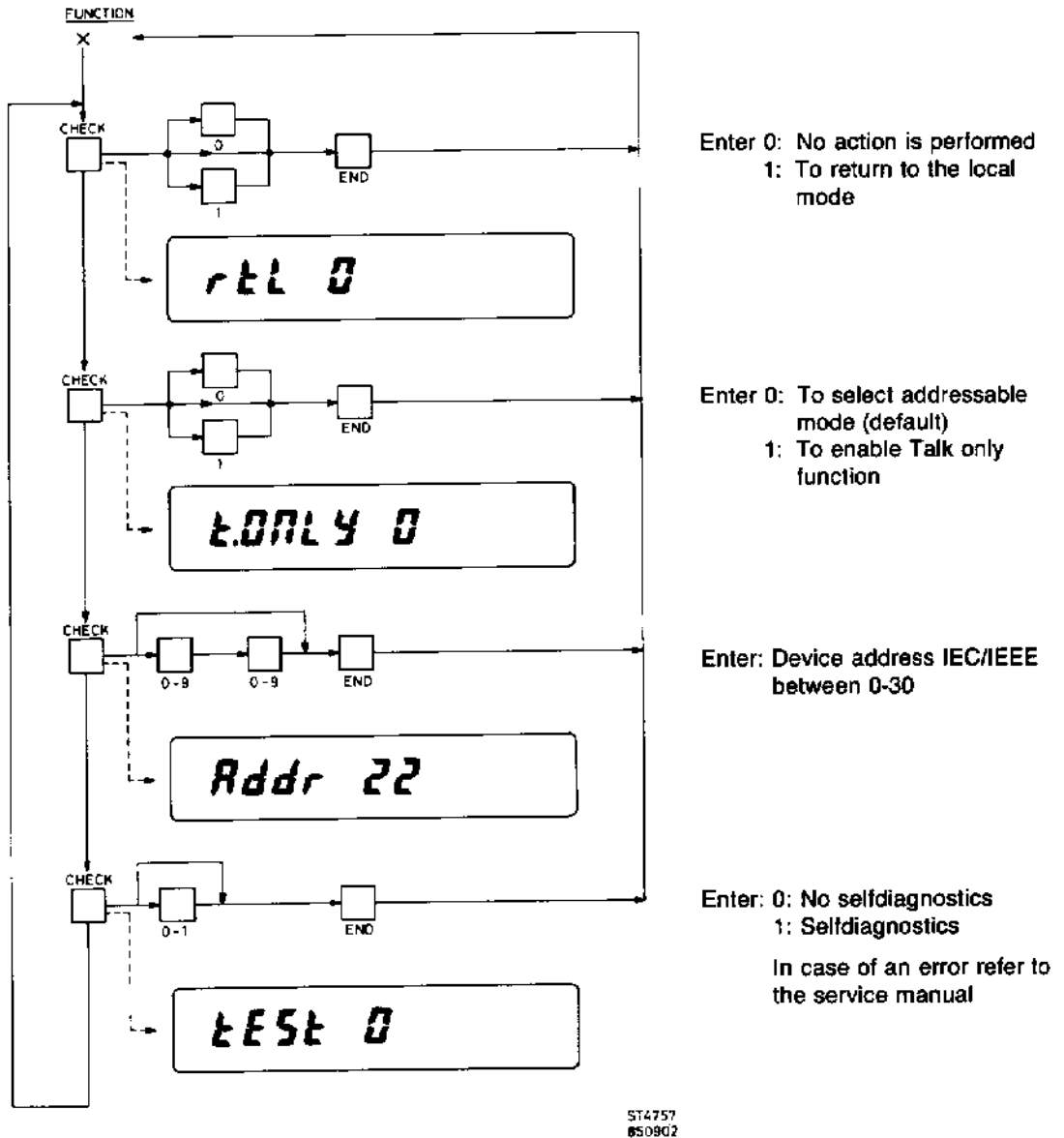

#### 4.3.3.8 Reset

The Reset switch (pencil-operation to avoid an unwanted reset) is used to give a reset. The instrument jumps to its initial state. All the functions are selected that are also valid after a power-on.

#### 4.3.3.9 Cal

Via the CAL switch (pencil operation) the electronic calibration mode is enabled. While pressing the CAL switch the RESET switch must be pressed. Release the RESET switch before releasing the CAL switch (cal on display).  
The calibration mode is entered after pushing the CHECK button.

In the calibration mode the separate functions and ranges can be calibrated successively. The new calibration values are stored in a non-volatile RAM.

The calibration mode is left with the END push button and disabled with the RESET switch.

For detailed calibration information refer to the service manual of the PM2534.

### 4.3.4 Measuring functions

The measuring functions, available on the PM2534 are selected by the appropriate function switch. Having selected the required function, further actions that are necessary are referred to in the following quick-check measuring procedure.

#### 4.3.4.1 Direct voltage measurements

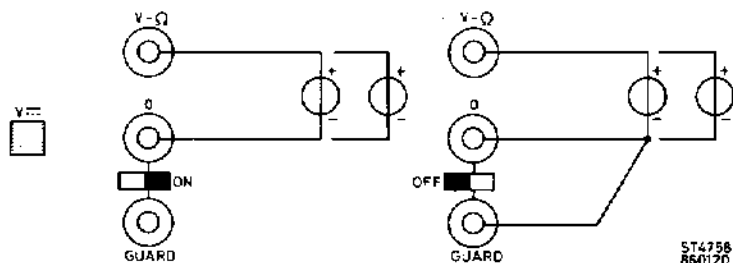

#### Valid modes

Ranging			Trigger		Speed				Filter		Null	Check/
Down	Up	Aut/Man	INT	Single	1	2	3	4	Freq	Dig		End
*	*	*	*	*	*	*	*	*		*	* )*	*

)\* 300 mV only

Range	Speed			
	1	2	3	4
1 300 mV	300.0000	300.000	300.00	300.0
2 3 V	3.000000	3.00000	3.0000	3.000
3 30 V	30.00000	30.0000	30.000	30.00
4 300 V	300.0000	300.000	300.00	300.0

#### Remarks:

Maximum input voltage

Range: 300 mV/3 V

400 V for <30 s  
300 V continuously  
600 V peak

30 V/300 V

400 V continuously  
600 V peak

Warning indications

Audible: >300 V in 300 V range  
Visual: Clip indication  
OL Overload

4.3.4.2 Alternating voltage measurements

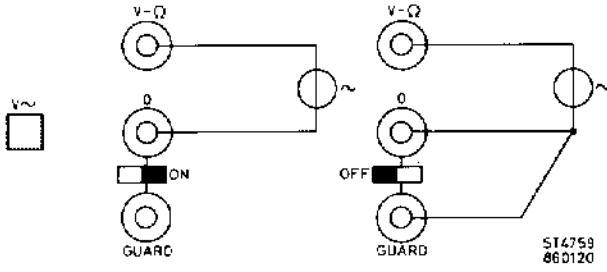

Valid modes

Ranging			Trigger		Speed				Filter		Null	Check/
Down	Up	Aut/Man	INT	Single	1	2	3	4	Freq	Dig		End
*	*	*	*	*		*	*		*			*

Range	Speed	2	3
	1 300 mV		300.00
2 3 V		3.0000	3.000
3 30 V		30.000	30.00
4 300 V		300.00	300.0

Remarks:

Maximum input voltage

All ranges

400 V ac or 400 Vdc  
continuously  
600 V peak

Warning indications

Audible: >300 V in 300 V range  
Visual: | Crest factor exceeded  
OL Overload

4.3.4.3 Resistance two-wire measurements

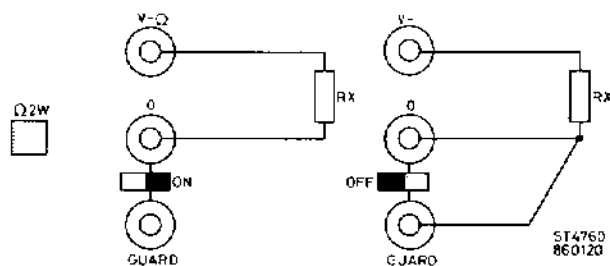

Valid modes

Ranging			Trigger		Speed				Filter		Null	Check/
Down	Up	Aut/Man	INT	Single	1	2	3	4	Freq	Dig		End
*	*	*	*	*	*	*	*	*		*		*

Range \ Speed	Speed			
	1	2	3	4
1 3 kΩ	3.000000	3.000000	3.000000	3.000000
2 30 kΩ	30.000000	30.000000	30.000000	30.000000
3 300 kΩ	300.000000	300.000000	300.000000	300.000000
4 3 MΩ	3.000000	3.000000	3.000000	--
5 30 MΩ	30.000000	30.000000	30.000000	--
6 300 MΩ	300.000000	300.000000	300.000000	--

Remarks:

Protection

2-wire terminals  
250 V ac or dc  
350 V peak

Warning indications

Visual: 1 Clip indication  
OL Overload.

4.3.4.4 Resistance four-wire measurements

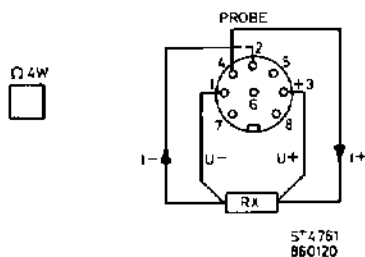

Valid modes

Ranging			Trigger		Speed				Filter		Null	Check/
Down	Up	Aut/Man	INT	Single	1	2	3	4	Freq	Dig		End
*	*	*	*	*	*	*	*	*		*		*

Range \ Speed	Speed			
	1	2	3	4
1 3 kΩ	3.000000	3.00000	3.0000	3.000
2 30 kΩ	30.00000	30.0000	30.000	30.00
3 300 kΩ	300.0000	300.000	300.00	300.0
4 3 MΩ	3.000000	3.00000	3.0000	--

Remarks:

Protection

4-wire terminals  
30 V ac or dc  
continuously  
42 V peak

Warning indications:

Visual: 1 Clip indication  
OL Overload

4.3.4.5 Direct current measurement

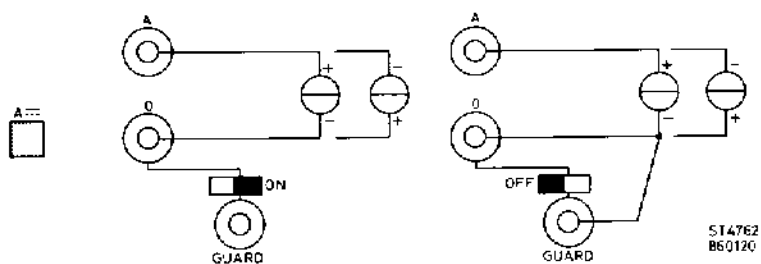

Valid modes

Ranging			Trigger		Speed				Filter		Null	Check/
Down	Up	Aut/Man	INT	Single	1	2	3	4	Freq	Dig		End
*	*	*	*	*		*	*	*		*		*

Range	Speed		
	2	3	4
1 30 mA	30.0000	30.000	30.00
2 3 A	3.00000	3.0000	3.000

Remarks:

Protection

With a fuse of 3.15 A (fast blow)

Warning indications

Visual: 1 Clip indication  
 OL Overload  
 Audible: >3 A in 3 A range



4.3.4.6 Alternating current measurements

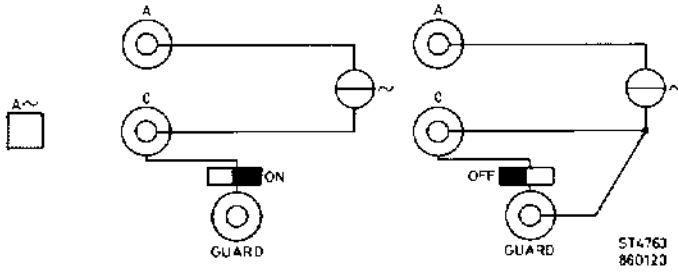

Valid modes

Ranging			Trigger		Speed				Filter		Null	Check/
Down	Up	Aut/Man	INT	Single	1	2	3	4	Freq	Dig		End
*	*	*	*	*		*	*		*			*

Range \ Speed	2	3
	1 30 mA	30.000
2 3 A	3.0000	3.000

Remarks:

Protection

With a fuse of 3.15 A (fast blow)

Warning indications

Visual: 1 Crest factor exceeded  
OL overload

Audible:  $\approx$  >3 A in 3 A range

## 4.3.4.7 Temperature measurements

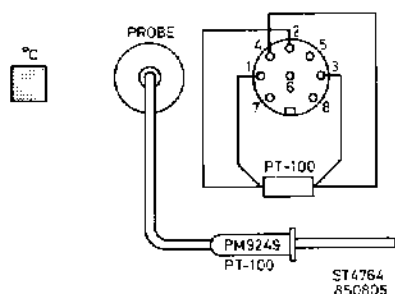

## Valid modes

Ranging			Trigger		Speed				Filter		Null	Check/
Down	Up	Aut/Man	INT	Single	1	2	3	4	Freq	Dig		End
			*	*		*	*					*

Range	Speed	2	3
	- 100 °C up to 850 °C		3000.0

## 4.3.4.8 Clipping- Crest- factor indication

Measuring dc voltages or currents with spikes can give an incorrect reading. The reading appears to be good but due to spikes the input circuit is overloaded and the reading is incorrect. The PM2534 indicates this with a 1 on the display.

When the display shows 1, a higher range must be selected until the 1 disappears.

Example:

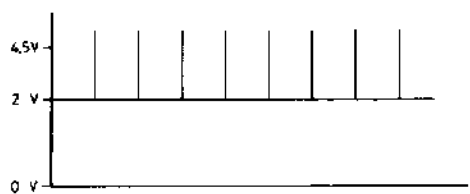

S\*4744

If a spike exceeds a level of 1,5x full scale value the clip indication is displayed.

In V $\sim$  or A $\sim$  the 1 symbol is used to indicate that the max. allowable crest-factor has been exceeded.

#### 4.4 IEC-625/IEEE-488 interface

##### 4.4.1 General

The PM2534 is an automatic ranging multimeter equipped as standard with an IEC/IEEE interface. It is designed to comply with the IEC-625/1 publication and has full remote control capabilities.

This section deals with hardware and software aspects of bus operation and describes programming functions in detail. Included are: general bus commands, device-dependent commands, status word and other operating commands. Via the interface, all functions are controllable that are normally selected by the front push-buttons. However, a number of special commands are implemented to meet the requirements of a system multimeter.

##### 4.4.2 Specifications

###### 4.4.2.1 Functional specification

Function	Identification	Description
Source-handshake	SH1	Complete capability
Acceptor	AH1	Complete capability
Talker	T5	Basic talker Serial poll possible Talk-only possible Unaddressed if "MY LISTEN ADDRESS"
Listener	L4	Basic listener Unaddressed if "MY TALK ADDRESS"
Service Request	SR1	Complete capability
Remote/Local	RL1	Complete local LOCK-OUT capability
Device Trigger	DT1	Complete capability
Device clear	DC1	Complete capability
Bus Drivers	E1	Open collector Isink 48 mA

###### 4.4.2.2 Code specification

Code in use:

Separator for input data:

Separator for output data:

ISO 7-bit (ISO-646).

Fully programmable; initial separator after POWER-ON; LF or the END message (EOI).

Same as the input separator; always with the END message.

4.4.2.3 Connector pinning  
Type of connector:

24-pin female connector, contact assignment in accordance with IEEE-488.

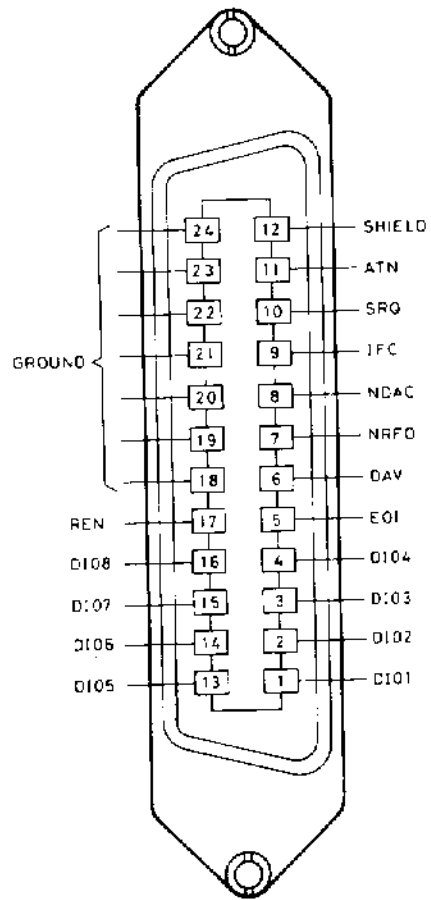

IEEE-488/IEC-625

ST 3891

4.3.2 Front rear panel

4.3.2.1 Display

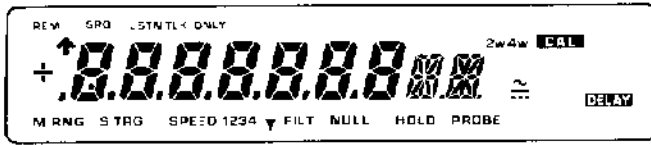

ST4743

IEC/IEEE MESSAGES

- REM = Remote
- LSTN = Listener
- TLK = Talk
- TLK ONLY = Talk-only
- SRQ = Service Request

**Cal** : Calibration mode on

**Delay**: Delay switched on (only via IEEE)

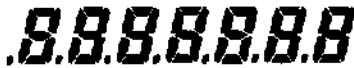

Display with decimal point (Result)



Messages Unit indication mV, V, Ω, A etc.

**Clip** (V<sub>max</sub>, A<sub>max</sub>) or Crest factor (V<sub>~</sub>, A<sub>~</sub>) indication

**2w4w** Configuration indication Ω  
 2W = 2 wire } resistance measurements  
 4W = 4 wire } via probe input

**÷** Polarity indication  
 V<sub>max</sub>, A<sub>max</sub>, °C

**~** ac/dc indication  
 ~ in V<sub>~</sub>, A<sub>~</sub>  
 = in V<sub>max</sub>, A<sub>max</sub>

**M RNG** Manual ranging indication

**PROBE** Message: This function needs a probe.

**S TRG** Single trigger indication

**HOLD** Data hold indication, in combination with a DATA HOLD probe.

**SPEED 1234** Measuring speed indication

**NULL** Zero point correction indication (V<sub>max</sub>, 300 mV).

**▼** Blue mode indication (Blue text is valid)

**NoCal** instrument must be adjusted (refer to the service manual)

**FILT** Filter on indication  
 \* 40 Hz in functions V<sub>~</sub>, A<sub>~</sub>  
 \* Digital filter in functions V<sub>max</sub>, A<sub>max</sub>, Ω-2W, Ω-4W,

4.4.2.4 Timing specification

Interface messages (with ATN = 1) received e.g. MLA, MTA, UNL, GTL.

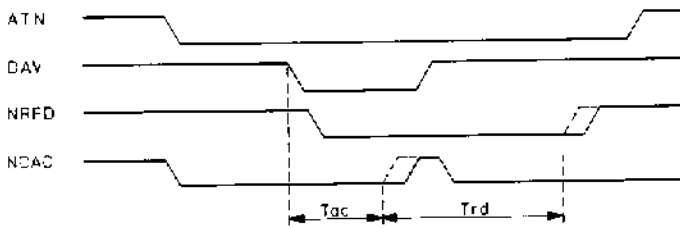

ST 3558

T<sub>ac</sub> = accept time; time needed to accept the interface message: 70 μs.  
 T<sub>rd</sub> = ready time; time needed until acceptor can receive new data: >220 μs.

Data bytes (any input) received (with ATN = 0)

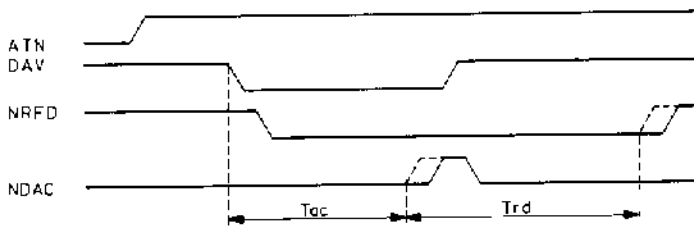

ST 3559

T<sub>ac</sub> = accept time; time needed to accept the data byte.  
 - for the first data byte (after addressing): 90 μs.  
 - for the second and following data bytes: 90 μs.  
 T<sub>rd</sub> = ready time; time needed until acceptor can receive new data: >350 μs.

Output data (measuring data and status data)

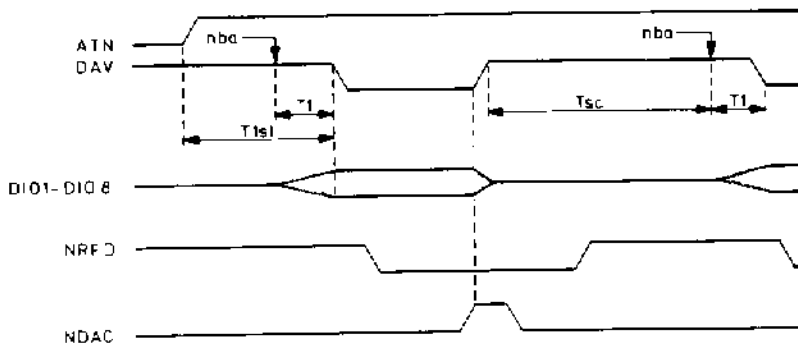

ST 3563

T<sub>1</sub> = settling time (according IEC625-1, section 3 cl 24): >150 μs.  
 T<sub>1st</sub> = time needed for the first data byte to become available on the bus: >400 μs (only if valid data is available).  
 T<sub>sc</sub> = source time needed for next data byte to become available: >250 μs.

**Execution time of the GET command (Group execute trigger)**

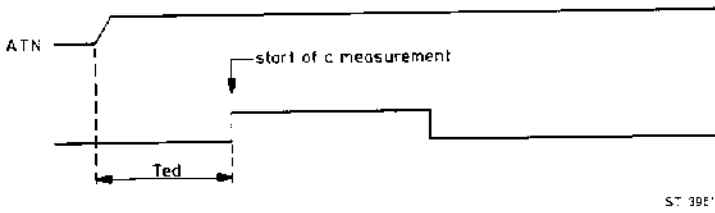

ST 39E'E

Ted = execution delay time for the GET command: >500 μs.

**4.4.2.5 Switch specification**

To select the address, talk only, etc. the CHECK mode, must be used. In this mode, all the numeral buttons (0-9) can be used to change the settings. The END button terminates the input given in the CHECK mode (see also section 4.3.2.3). The settings are stored in RAM and will be kept in memory even when the POWER is switched off.

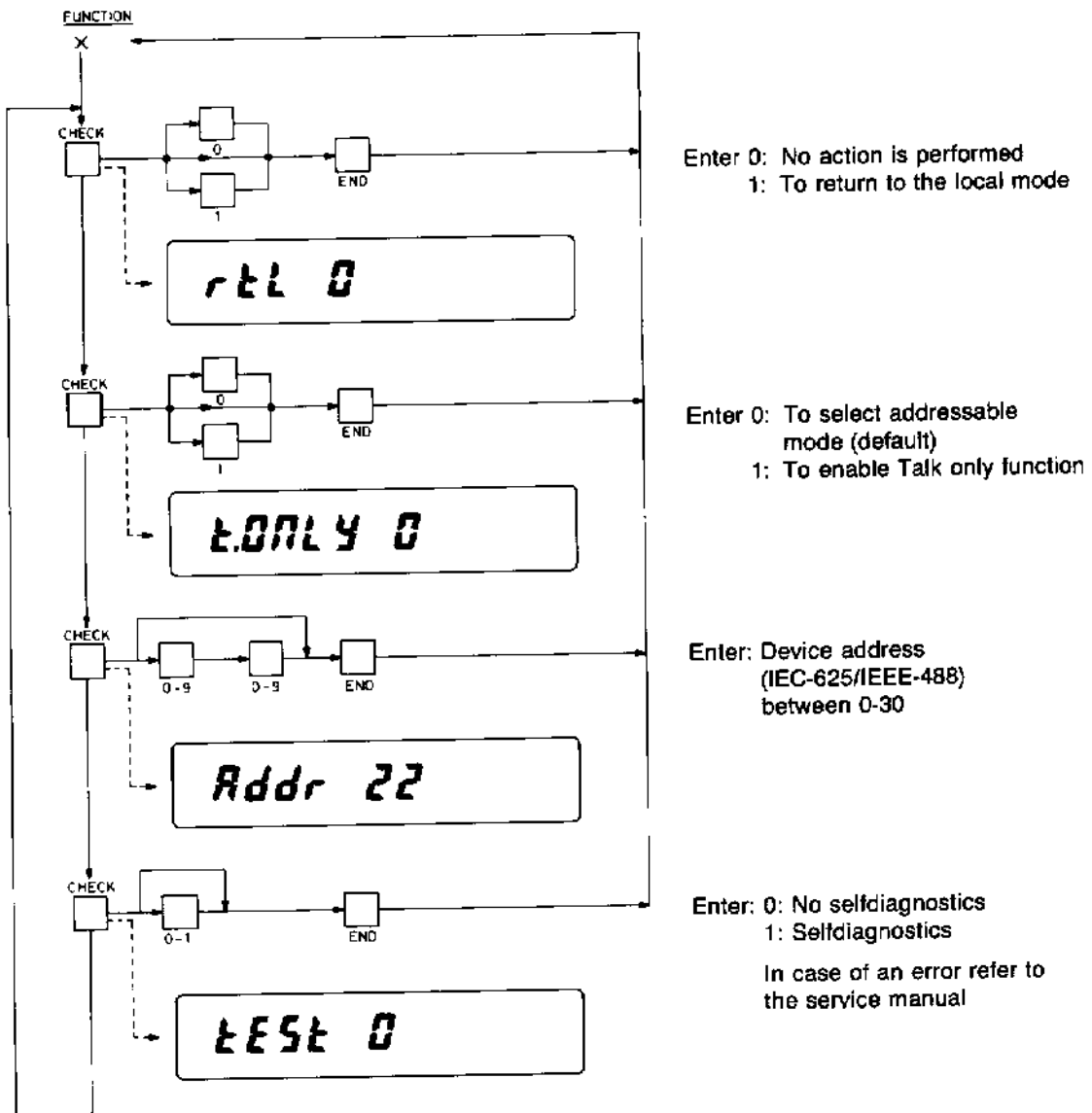

ST4757  
850902

- Return to local

When the display shows the indication "REM" the PM2534 is in the remote state. In this state, the instrument can be controlled by commands received via its interface. All control of the instrument via the front knobs is disabled, except for the CHECK and single trigger (single trigger chosen via IEC/IEEE command) key. Pushing this key gives rtl 0 in the display. Entering a 1 before pushing the END button causes the instrument to go to the local mode. With this action, the PM2534 can be set to the local state only if the remote state is not locked (LLO).

- Talk-only

Some applications may require that the PM2534 sends out readings to a device such as a printer without the aid of a controller. The talk-only mode allows this transaction. The PM2534 is set to the talk-only mode (2 x check), entering a "1" when the display shows "t.only 0" before pushing END. The state is kept in memory. Measurement data is output after each completed measurement. Function and range settings etc. must now be performed by the front-panel knobs.

- Addressable mode

If the interface is in the addressable mode, the PM2534 can be connected to a controller. After receiving its listen or talk address, the interface is addressed as listener or talker respectively. The address is selected when the display shows (e.g.) Addr 22 (3 x check). Entering the address before END will change the address and will be kept even if the power is turned off. Only addresses between 0-30 are allowed. Pressing END without having changed a value causes an escape from the check mode.

#### 4.4.3 Programming the PM2534

##### 4.4.3.1 General information

Programming the PM2534 is divided in to three main parts Viz Interface Programming, Interface program data and Device programming.

The commands listed under interface programming do not influence the device functions. It is recommended to program first separators and service request masking.

##### 4.4.4 Interface programming

- Remote state

When the display indication "REM" is on, the PM2534 is in the remote state. In this state, the instrument can be controlled by device-dependent data via its interface. All control of the instrument via the front-panel is disabled, except for the CHECK key and single trigger (when chosen). With the CHECK key, the return-to-local function can be chosen only if the remote state is not locked.

- Local state

When the front indication "REM" is off, the PM2534 is in the local state. In this state, the instrument can be controlled via its front keyboard. All control data received via the interface will be cancelled and not executed. In the remote state, the local state is chosen via the GTL (goto local) command.

- Device clear

By a device clear command the PM2534 is initialised. This command is comparable with POWER ON or RESET.

The device clear command can be given by:

- DCL Device clear
  - SDC Selected device clear
- } ASCII table

- Trigger command (see also section 4.4.9)

To start a measurement in the PM2534 a trigger command can be given by:

- GET (group execute trigger).
- X1

- Serial Polling (see also section 4.4.9)

The serial polling sequence is used to obtain the status byte of the PM2534. It is used to determine which of several devices has requested service over the SRQ line. However, the serial polling sequence may be used at any time to obtain the status byte, to give information of settings.



#### 4.4.4.1 Interface program data

Interface program data is used to specify the different interface settings or parameters. A message unit consists always of a header-body combination and **must always** be preceded by the listener address. The following structure of a program message must be used.



ST4090E

*Note: Before every header-body combination the listener address must be sent.*

#### 4.4.4.2 Sending program data

The following program data can be given.

#### INTERFACE PROGRAMMING

Function	Message	Description
Service request	MSR n [n] [n]	Setting of the service request mask. n [n] [n] is the decimal equivalent bit pattern
Separators	SPR nn [, nn]	Setting of the separators. nn is the decimal equivalent of a character of the ISO code table.
Identity	ID ?	On receipt of this command the identity is returned.
Interface test	TSI U TSI <dec 170>	On receipt of these commands a self test is performed. (U = with service request) (<dec 170> means without service). 170 is the decimal value and can be programmed on most controllers with CHR\$(170).

*Note: [ ] means optional*



#### 4.4.4.4 Separators

A record separator terminates the output or input sequence. It indicates that there is no additional information available. The PM2534 is capable of handling single and double input and output record separators. The record separator character(s) can be programmed to one or two characters of the ISO code table. An ESC character is not acceptable as a record separator but no error message is given and the last programmed separator(s) will remain valid. At POWER ON the separator is: NL (LF)

*Note: For input data, the PM2534 allows but does not require the END message (EOI line). However, the PM2534 always sends out the END message concurrently with the last record separator character.*

To program the separators the following sequence has to be used.

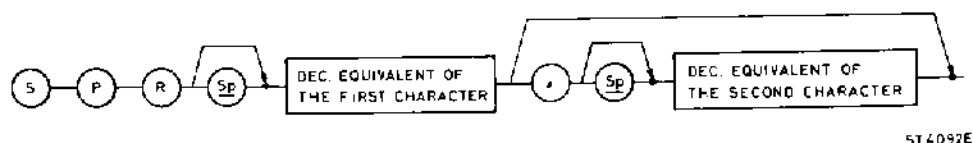

Example: SPR 13,10 programs a CR LF sequence as input and output separator.

#### 4.4.4.5 Identity

If the interface programming code ID? is decoded, and the PM2534 becomes talker, it responds with PM2534xSyy

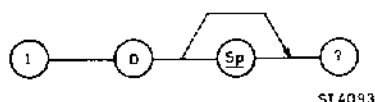

x = hardwareversion (e.g. 0)  
yy = softwareversion (e.g. 01)

Any additional data bytes sent in the program string are lost.

#### 4.4.4.6 Interface test

On receipt of TSI U a interface self-test is performed. If correct, a response with a byte of decimal equivalent 170 is sent on the bus when the PM2534 becomes talker. A service request is generated. If a byte of decimal equivalence 170 is received instead of the U, the same interface self-test is performed, but no service request is generated and the character U is sent out on the bus.

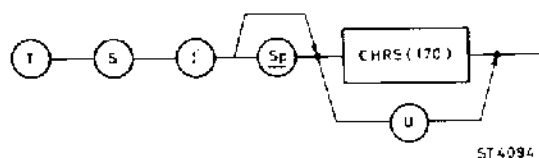

Additional data bytes are lost.

**4.4.5 Device programming**

Device-dependent messages are used for device control purposes. The basic units consists of a header, a body and a separator. However, a complete program message may consist of one or more units. The following structure has to be used.

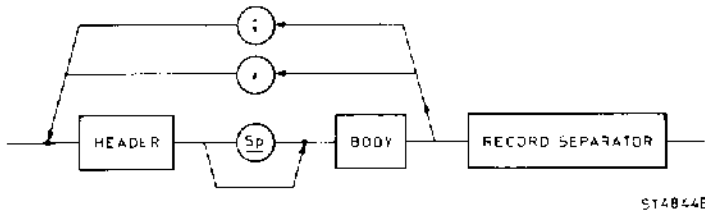

ST4844E

The unit separator (comma), or semi colon must be used between the units. Upper and lower case characters are allowed. The execution of a message is according to the input sequence.

Example: "RNG AUTO,X1"

The device messages relating to the input data for the PM2534 deal with measurement start commands, speed and range selection, trigger modes function selection and display modes. These are listed on the next page.

**4.4.5.1 Function selection**

With this command, one of the seven functions is selected. The select function command sets the PM2534 to predetermined states as defined in the following table. All other program data not mentioned in the table will remain if another function has been chosen.

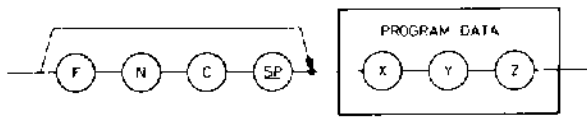

ST4766E

Function	Program data x y z	Ranging	Speed	Filter	Internal settling time
V $\overline{\sim}$	VDC	AUTO	2	OFF	ON
V $\sim$	VAC	AUTO	2	ON	ON
$\Omega$ -2w	RTW	AUTO	2	OFF	ON
$\Omega$ -4w	RFW	AUTO	2	OFF	ON
A $\overline{\sim}$	I DC	AUTO	2	OFF	ON
A $\sim$	I AC	AUTO	2	ON	ON
$^{\circ}$ C	TDC	AUTO	2	OFF	ON

Ask function:

On receipt of the FNC ? command the actual function is output.

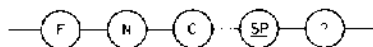

ST4767

Function	Output
V $\overline{\sim}$	FNC VDC
V $\sim$	FNC VAC
$\Omega$ -2w	FNC RTW
$\Omega$ -4w	FNC RFW
A $\overline{\sim}$	FNC IDC
A $\sim$	FNC IAC
$^{\circ}$ C	FNC TDC

#### 4.4.5.2 Range selection

Range selection is achieved by sending the characters RNG as header. The body may consist of a decimal value with or without decimal point. Also a technical or scientific notation is allowed.

A range is chosen by the instrument when the body is programmed as the expected measuring value. It is also possible to program the end of the range or a value within a range. The instrument will always choose the lowest possible range.

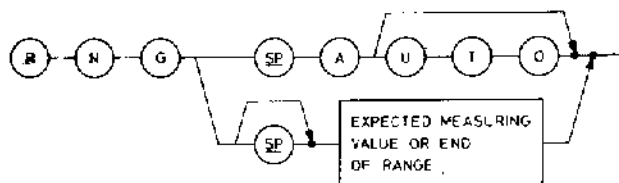

ST4768E

Ask range:  
Sending the command.

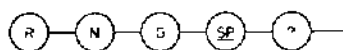

ST4769

will output the selected range

Examples for output: RNG 300.E+06 (300 M $\Omega$  range MAN ranging)  
RNG 30.E+00 (30 V range MAN ranging)

**Note:** Programming functions and ranges can be combined in one command. The headers FNC and RNG are in this case not necessary. The bodies described in section 4.4.5.1 are used for this command as a header.

VDC 200	will select	$V_{\text{DC}}$ range 300 V
VDC 0.001	"	$V_{\text{DC}}$ range 300 mV
VAC 2.0 E-3	"	$V_{\text{AC}}$ range 300 mV
RTW 1.5 E+3	"	$\Omega$ -2W range 3 k $\Omega$
IAC AUTO	"	auto ranging

#### 4.4.5.3 Measuring Speed/Resolution

The speed and the resolution are determined by the Analog-to-digital converter and depend also on the selected function and range. These functions are displayed with SPEED 1 (2,3,4) as a relative number (1 = lowest speed and 4 = highest speed). The instrument selects the right combination of measuring speed and resolution. Default is speed 2 for all measuring functions. Changing the measuring function will select this speed.

##### - Measuring Speed

With the following command the measuring speed is selected.

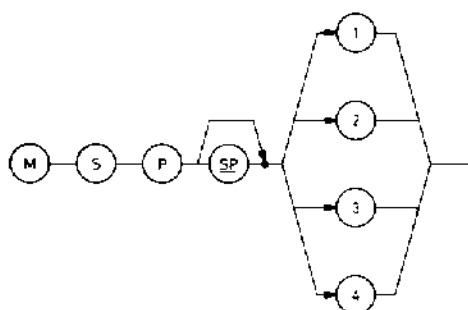

ST4770

Ask measuring speed.

The command

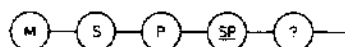

ST4771

will output the actual measuring speed.

Example: MSP 3

##### - Resolution

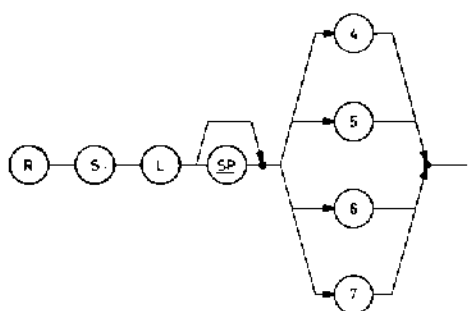

ST4772

With this command a resolution of 4, 5, 6 or 7 digits is chosen.

*Note: A non-valid resolution/measuring speed combination results in a program failure. After programming of resolution and speed the last command is always executed.*

With the command

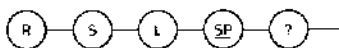

ST4773

the actual resolution is output.

Example: RSL 5

## 4.4.5.4 Filter

The filter function (see also section 4.3.3.5) can be switched ON/OFF by means of:

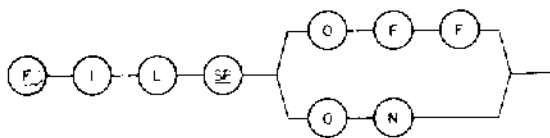

ST14774

*Note: Changing the function will select the default state.*

Ask filter state.

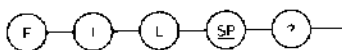

ST14775

After sending this command, the PM2534 gives the state of the filter.

Example: FIL OFF

## 4.4.5.5 Trigger modes

The PM2534 has two trigger modes, namely Internal and Single. Selecting internal triggering will give a continuous measuring of the instrument.

At single triggering the instrument must be started via a start command. This command can be given via the keyboard, via the IEC/IEEE bus or via the EXT TRIG input at the rear. Changing the function does not alter the selected trigger mode.

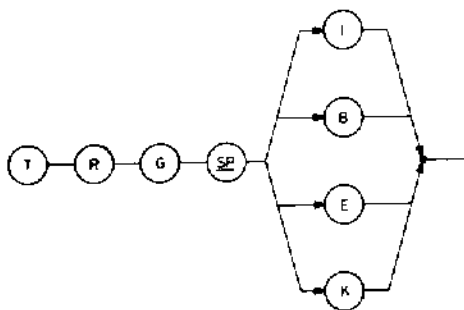

ST14778

- I: Internal triggering
- B: Single triggering via IEC/IEEE bus
- E: "EXT TRIG" input
- K: Single triggering via IEC bus, EXT TRIG input or via the keyboard.

Ask trigger mode:

ON receipt of:

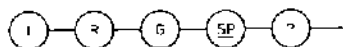

ST14779

the trigger mode is output.

Example: TRG E

## 4.3.2.2 Keyboard

The keyboard is subdivided into a number of functional groups

- Function
- Ranging
- Trigger
- Miscellaneous

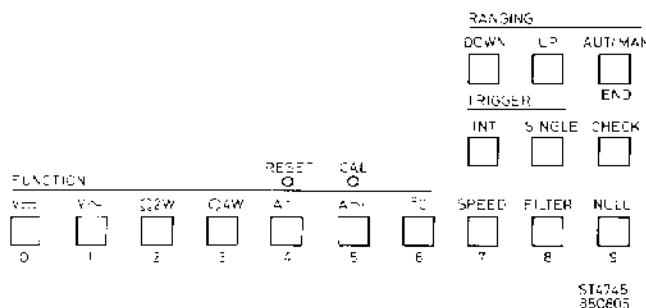

- **Function**  
Selects the measuring functions
- **Ranging**  
A selection can be made between manual (M RNG on display) or automatic ranging. The Up and Down buttons are used to range.
- **Trigger**  
A selection can be made between internal and single trigger (external trigger via BNC connector on the rear).
- **Speed**  
Measuring speed 1,2,3 or 4 can be selected. (The initial speed setting is always speed 2).
- **Filter**  
ON/OFF for ac filter in alternating measuring functions or digital filter for all (except °C) other functions.
- **Null**  
ON/OFF for offset correction in V<sub>DC</sub>, 300 mV. (NULL on display)
- **Check**  
The CHECK button switches on the self-tests, calibration mode, IEEE-488/IEC-625 parameters, service tests according to a menu.  
In this mode all the numerical buttons (0-9) can be used to modify settings, etc.
- **End**  
The END button terminates certain actions in the check mode.
- **Cal**  
The calibration mode (pencil-point operation) is enabled.
- **Reset**  
Pushbutton (pencil-point operation) to reset to initial state.



4.4.5.6 Internal settling time

The internal settling time is a waiting time after a start command. Before the ADC starts converting, the signal conditioning circuit needs time to settle. The settling time depends on the function, range and speed and is determined by the instrument. This settling time can not be changed via the front panel but can be switched OFF via the IEC-625/IEEE-488 interface to obtain faster measurements. With the following command the settling time can be switched ON/OFF.

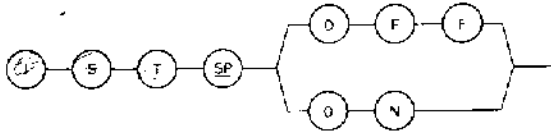

ST4776

Ask state internal settling time:

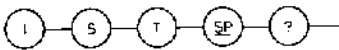

ST4777

This will give IST ON when the settling time is switched ON and IST OFF when it is switched OFF.

*Note: Changing the function will switch the internal settling time ON.*

4.4.5.7 Delay

The time between the start command and the conversion of the ADC can be changed by the delay command. It can be used if the PM2534 must make one measurement within a time period or it can be used to define a new settling time. This delay command is not available on the keyboard, but is programmable via the interface. The programmed delay is not changed at function change.

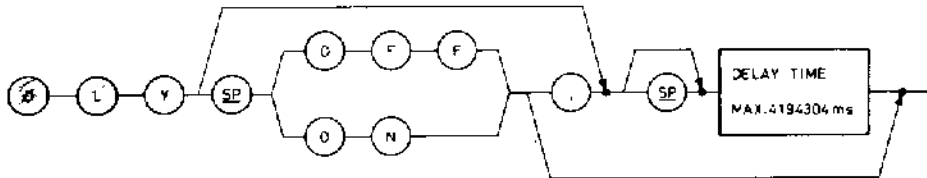

ST4780E

*Note: The value must be expressed in ms and must not exceed 4194304.*

Ask delay state:

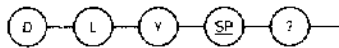

ST4781

gives the selected state and value.

Example: DLY ON,0000200

## 4.4.5.8 Start command

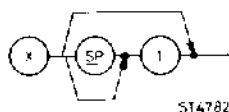

ST4782

starts a measurement in the actual function

## 4.4.5.9 Display mode

The display of the instrument can be switched OFF to increase the measurement speed.

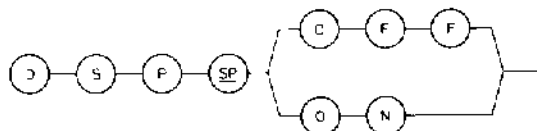

ST4783

*Note: The display mode is not altered when changing the function.*

Ask display mode:

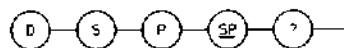

ST4784

Example: DSP OFF

The display can be filled with a value. This is done by sending the value as a character string to the instrument.

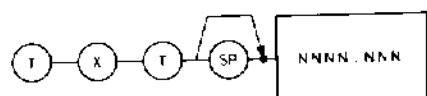

ST4785

nnnn.nnn is the value that is written in the display.

The following characters can be sent to the PM2534:

1	2	3	4	5	6	7	8	9	0	.	e	"	'	-	=	3	_									
1	2	3	4	5	6	7	8	9	0	.	e	"	'	-	=	3	_									
A	B	C	D	E	F	G	H	I	J	K	L	M	N	O	P	Q	R	S	T	U	V	W	X	Y	Z	?
A	B	C	D	E	F	G	H	I	J	K	L	M	N	O	P	Q	R	S	T	U	V	W	X	Y	Z	?

ST4786

*Note: 0, 1 or 2 decimal points can be sent.*

4.4.5.10 *Output mode*

The string (measuring value) which is output to the controller can be made shorter.

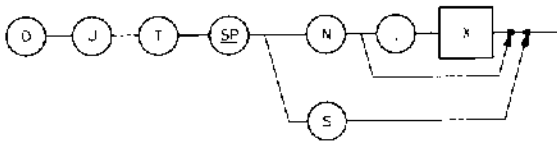

ST4787

S = string is complete output

N = only numeric values are output (only body)

N,x = only numeric values are output with length specified in x.  
Also dec. point and polarity are included in this number.

Example: OUT N,6 will give +036.4

*Note: The selected mode is not altered after changing the function.*

Ask output mode:

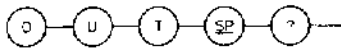

ST4788

gives the selected output mode.

Example: OUT N,5

## 4.4.5.11 Null

If a thermal e.m.f. occurs at the input sockets an offset voltage can arise. This offset voltage in  $V_{\text{---}}$ , 300 mV range can be compensated by pushing NULL if the input is short-circuited. This can also be done via the IEC-645/IEEE-488 interface. At POWER-ON or RESET this function is not active. The state is kept in memory during function changing, and will be used again when  $V_{\text{---}}$ , 300 mV is selected (Null function must be ON).

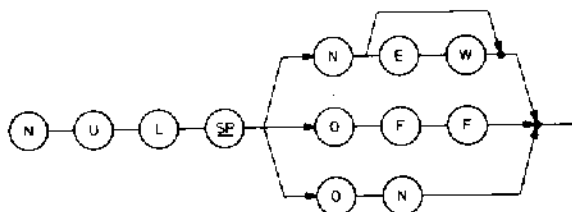

514789

**NEW:** The instrument is set in  $V_{\text{---}}$  300 mV range.

Also TRG K is selected (see section 4.4.5.5).

To compensate the offset, short-circuit the V- and 0 socket and give one of the trigger commands (X1, GET). Also single trigger can be pushed or a single trigger via the BNC connector can be given. The compensation value is stored in memory.

**OFF:** The Null function is switched off but the value is still kept in memory.

**ON:** The Null function is switched on with the stored value.

Ask Null state.



514790

gives the selected state.

Example: NUL OFF

## 4.4.5.12 System 21 mode

To enable responses from System 21 part the command:

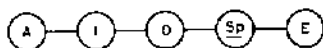

ST4896

has to be sent.

To disable responses from the System 21 part the command:

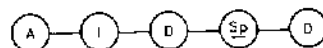

ST4870

has to be sent.

## 4.4.5.13. Survey of commands

The following table gives a survey of the commands that can be used to program the PM2534.

Commands	Description
Function	
[FNC_]xxx	xxx can be one of the following functions: VDC = Direct voltage                      IDC = Direct current VAC = Alternating voltage              iAC = Alternating current RTW = Ohm 2-wire                        TDC = Temperature °C RFW = Ohm 4-wire
Ranging	
RNG_A[uto] RNG ±aaa.aE±aa	Auto-ranging The expected measuring value or the end-of-range can be programmed as range in scientific or technical notation. (e.g. RNG 3 or RNG 3.000E+03).
Measuring Speed/ Resolution	
MSP x RSL x	x = integer between 1 and 4 to program the measuring speed x = integer between 4 and 7 to program the resolution.
Filter	
FIL_ON FIL_OFF	Filter is switched ON/OFF.
Trigger mode	
TRG_I TRG_B TRG_E TRG_K	Internal triggering. Single triggering via IEEE/IEC bus. "EXT TRIGGER" input. Triggering via the keyboard (Single triggering), via the "EXT TRIGGER" input or via the IEC/IEEE bus.
Internal settling time	
IST_ON IST_OFF	Internal settling time switched ON/OFF.
Delay	
DLY_ON DLY_OFF DLY x[xxxxxx]	The programmed delay is switched ON/OFF. The value x[xxxxxx] is stored as the delay value. Combination of these commands is possible (e.g. DLY_ON,234).
Start	
X [1]	Starts a measurement.
Display	
DSP_ON DSP_OFF TXT_XXXXXX	The display is switched ON/OFF. Text specified in XXXXXX is displayed.
TST	Selfdiagnostic mode switched on (Refer to service manual)

Commands	Description
Output mode	
OUT_S OUT_N OUT_N,x	The whole measuring data string is output. Only numeric results are output. A numeric result is output with a length specified in x.
Null mode	
NUL_ON NUL_OFF NUL_N[EW]	The Null function is switched ON/OFF. A new Null value is stored in memory.
Cal mode	
CAL_ON CAL_OFF	The cal mode is switched ON/OFF
System 21	
AID_E AID_D	Output from System 21 part is enabled/disabled

Note: [ ] means optional, \_ means a space (is necessary).

#### 4.4.6 Calibration via the controller

The calibration mode can be called via the IEEE-488/IEC-625 bus. To enable the calibration mode push the CAL (pencil operation) and the RESET switch. Release the CAL switch after the RESET switch. The calibration mode is indicated on the display with the CAL symbol.

Via the command CAL ON the calibration mode is started and the first range can be programmed. The normal commands to select a range or function can be used. On receipt of CAL ? the CAL state is output (Example: CAL OFF).

For detailed calibration information, refer to the service manual of the PM2534.

#### 4.4.7 Selfdiagnostics via the controller

It is possible to choose the selfdiagnostic mode via the interface.

This is done with the command TST.

Refer to the service manual of the PM2534 for detailed information.

4.4.8 Output data

4.4.8.1 Measuring data

Measurements are sent out as header body combinations

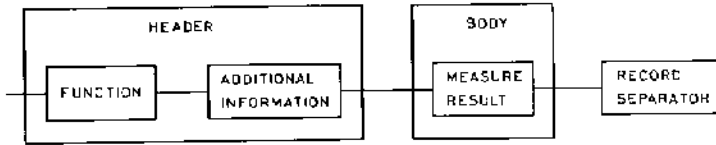

ST4098 E

FUNCTION

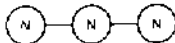

ST4791

The first part of the header (nnn) is a three character indication of the function separated by a space from the second part. The possibilities for nnn are given in the following table.

Function	Characters 1 2 3
V---	VDC
V~	VAC
Ω-2w	RTW
Ω-4w	RFW
A---	IDC
A~	IAC
°C	TDC

ADDITIONAL INFORMATION

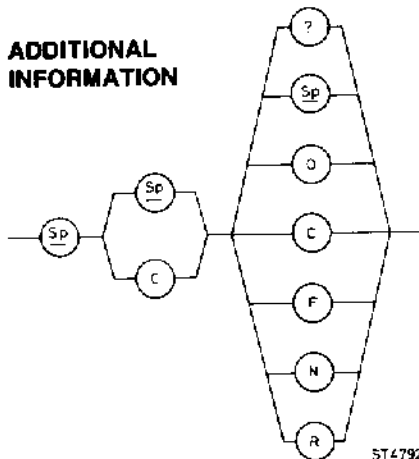

ST4792

The second part of the header gives additional information

- Sp Space } 4th character
- C Calibration measurement } 5th character
- Sp Space } 5th character
- O ADC overload } 6th character
- C Crest-factor, (V~, A~), clipping input circuit (other functions) } 6th character
- F Fail at calibration measurement } 6th character
- N Failure at NULL-measurements } 6th character
- R Reduce accuracy due to an unstable input signal } 6th character
- Sp Space } 6th character
- ? Dummy measurement (Single trigger mode) } 6th character

**MEASURING RESULT (body)**

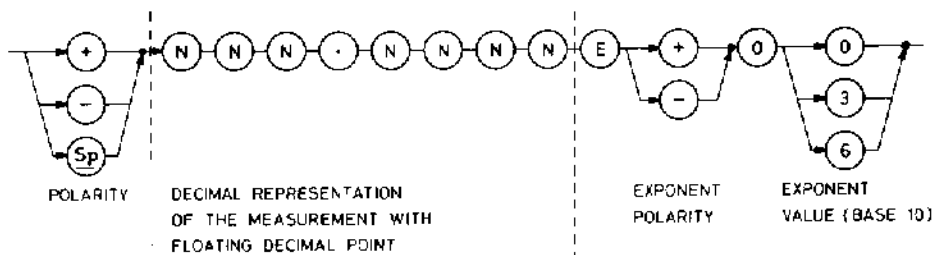

ST4793E  
850902

**RECORD SEPARATOR**

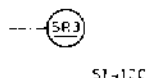

**SR3** is the record separator with the END message. The record separator is programmable (see section 4.4.4.4). The initial state after POWER ON is: NL  
Data examples, and their representation in a header body are shown below.

Characters	1	2	3	4	5	6	7	8	9	10	11	12	13	14	15	16	17	18	19	20
	V	D	C	<u>Sp</u>	<u>Sp</u>	C	+	1	2	3	.	4	5	6	7	E	.	0	3	<u>SR3</u>
	R	T	W	<u>SP</u>	<u>Sp</u>	<u>Sp</u>	+	1	2	.	3	4	5	6	7	E	+	0	3	<u>SR3</u>

**4.4.8.2 Dump**

After the dump command, the PM2534 sends all the settings to the controller.

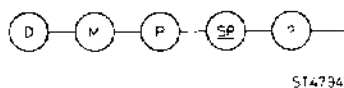

The output is always in a determined pattern as described in the section, Device Programming.

Remember: This outputted string can also be used to program the PM2534. The identical setting of the instrument is performed.

Example: FNC VDC;RNG 300.E—03;MSP 2;RSL 5;FIL OFF;IST ON;TRG B;  
DLY OFF,0000150;DSP ON;OUT N,3;NUL OFF;CAL OFFLF

*Note: To avoid occasional incorrect read-out (measuring result) in the internal trigger mode, a delay of some machine cycles is advised.*

Example P2000 C: 10 IEC INIT  
20 IEC PRINT #22, "DMP?"  
Delay → 30 R=B  
40 IEC INPUT #22, A\$  
50 PRINT A\$



## 4.4.8.3 Output of settings

The programmed PM2534 can give its setting by the DMP command (see section 4.4.8.2). However, the individual settings can also be obtained from the instrument. The instrument outputs a setting as it receives the header which is normally used to program the setting, and a question mark as body.

See the following table for outputs.

Command	Description	Output (possibilities)
FNC ?	FUNCTION	FNC VDC            FNC IDC FNC VAC            FNC IAC FNC RTW            FNC TDC FNC RFW
RNG ?	RANGE	RNG    AUTO RNG xxx.E ± xx (x = numbers between 0-9)
MSP ?	MEASURING SPEED	MSP 1              MSP 3 MSP 2              MSP 4
RSL ?	RESOLUTION	RSL 4              RSL 6 RSL 5              RSL 7
FIL ?	FILTER MODE	FIL OFF FIL ON
IST ?	INTERNAL SETTLING TIME	IST OFF IST ON
TRG ?	TRIGGER MODE	TRG I TRG B TRG E TRG K
DLY ?	DELAY	DLY OFF,xxxxxxx (x = numbers between 0 and 9) DLY ON,xxxxxxx
DSP ?	DISPLAY STATE	DSP OFF DSP ON
OUT ?	OUTPUT MODE	OUT S OUT N OUT N,x (x = numbers between 1 and 9)
NUL ?	NULL MODE	NUL OFF NUL ON
CAL ?	CAL MODE	CAL OFF CAL ON

## 4.4.8.4 Device status data

The device status data of the PM2534 is represented in one status byte (8 bits) and is built-up as follows:

bit 7	bit 6	bit 5	bit 4	bit 3	bit 2	bit 1	bit 0
EX	RQS	AB	BSY	EF3	EF2	EF1	EF0

EX	Extension (always 0)
RQS = 0	No request for service
RQS = 1	The PM2534 has requested for service
AB = 0	The PM2534 is not in an abnormal condition
AB = 1	The instrument is in an abnormal condition and is specified in the bits EF3 to EF0
BSY = 0	PM2534 is not measuring and the data of any previous measurement has been output.
BSY = 1	The PM2534 is measuring and/or data has not been output.

## Description

If AB = 1 then the bits EF3-EF0 indicate the abnormal condition.

AB	BSY	EF3	EF2	EF1	EF0	Description
1	x	x	x	x	1	Program failure (e.g. an illegal body has been received).
1	x	x	x	1	x	Internal failure (e.g. No Cal condition).
1	x	x	1	x	x	Incorrect measurement (OL, CF, failure in a calibration measurement or a faulty NULL measurement).
1	x	1	x	x	x	System 21 event.

*Note: One or more conditions can be specified simultaneously, by the instrument, in the status byte.*

*After a serial poll, the bits AB and EF3 to EF0 are reset to zero.*

If AB = 0 then the bits EF3 to EF0 indicate a normal condition.

AB	BSY	EF3	EF2	EF1	EF0	Description
0	0	x	x	x	0	No measurement is started and there is no data available.
0	1	x	x	x	0	A measurement is started but no data available.
0	1	x	x	x	1	Data is available, not yet sent via the interface.
0	0	x	x	x	1	Data is sent via the interface but remains available. Instrument can be triggered.
0	x	x	x	1	x	The HOLD mode is selected via the data hold probe.

4.3.2.3 Inputs

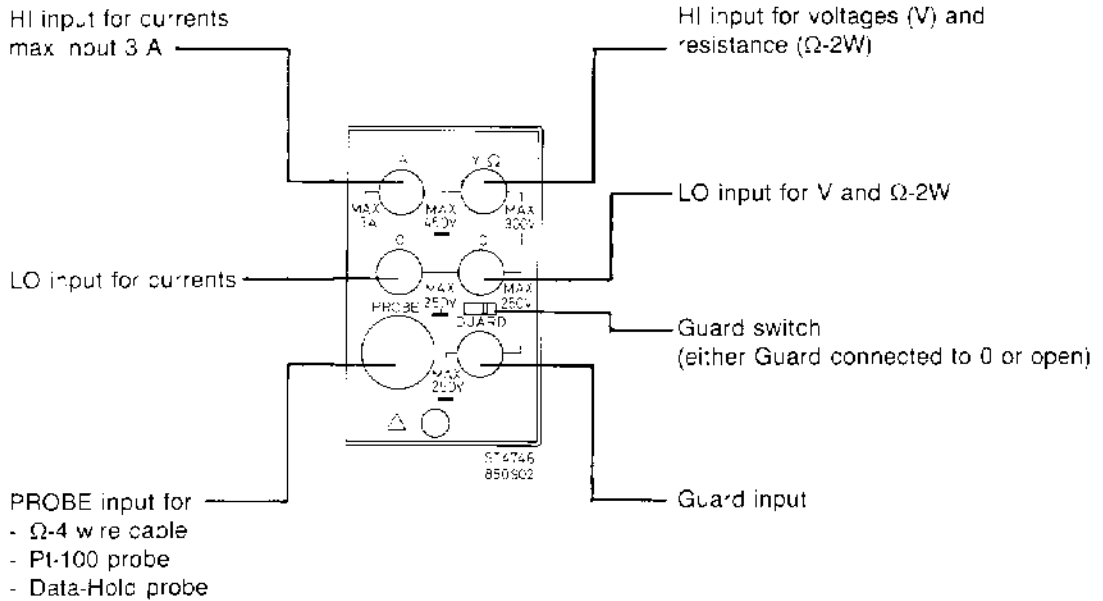

When measuring voltages, resistances or currents the corresponding 0-socket function must be used. Although these 0- sockets have the same potential, incorrect use could result in measuring deviations.

4.3.2.4 GUARD usage

The PM2534 is equipped with a GUARD. This is an additional shield between the "0" input and earth. The GUARD increases the leakage impedance. Increasing the leakage impedance improves the common mode rejection. The GUARD may be connected to the circuit via a separate lead. Proper use of the GUARD provides a better common mode rejection and a higher accuracy, especially in the most sensitive ranges. The guard can be connected via the switch to the 0-socket.

For an optimum GUARD connection, the following rules should be taken into account:

- Connect the signal to be measured to the PM2534 by means of a shielded measuring cable. This cable should not run parallel to heavy current cables.
- Connect the GUARD to the same potential as the "0" input terminal.
- Connect the GUARD in such a way that no current due to common mode voltage flows through any source impedance.

*Note: The guard must always be connected.*

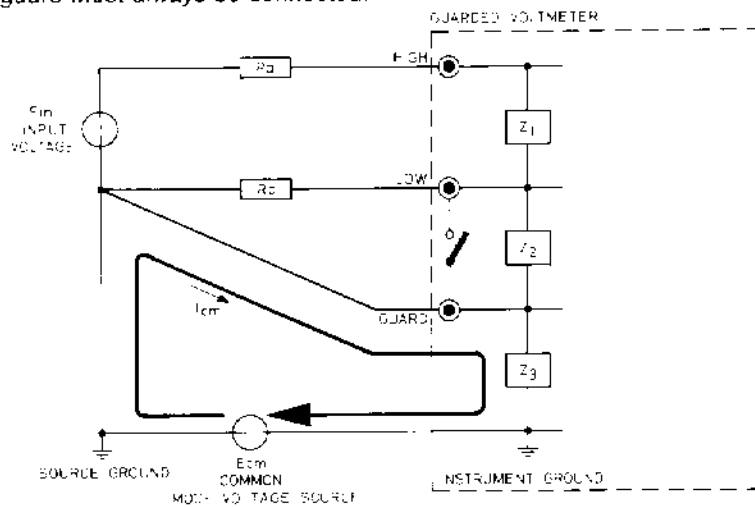

4.4.8.5 Identity

After the command ID? the identity is output:

Characters	1	2	3	4	5	6	7	8	9	10	11	12
	P	M	2	5	3	4	0	SP	S	0	1	SR3

↑  
depends on hardware version

↑     ↑  
depends on software version

4.4.8.6 Interface test

On receipt of TSI U or TSI + [CHR\$(170)] a self-test is performed.

Programming	Output data (test o.k.)	Remark
TSI U	dec. 170 [CHR\$(170)]	with service request
TSI + [CHR\$(170)]	U	without service request

4.4.9 Reasons for service request

Service is requested, if not masked, in the following way:

Program failure

If the PM2534 has received an illegal body or header the instrument responds with:

EX	RQS	AB	BSY	EF3	EF2	EF1	EF0
0	1	1	x	x	x	x	1

Internal failure

Service request will be given if an internal failure occurs. An internal failure is e.g. No Cal. The following will be given.

EX	RQS	AB	BSY	EF3	EF2	EF1	EF0
0	1	1	x	x	x	1	x

Incorrect measurement

Service will be requested when the PM2534 has made an incorrect measurement. This incorrect measurement can be Overload (OL), Exceeding the Crest factor (CF), if a failure occurs at a calibration measurement or when the instrument has made a faulty NULL measurement. It responds with:

EX	RQS	AB	BSY	EF3	EF2	EF1	EF0
0	1	1	x	x	1	x	x

## System 21 event

In the PM2534 the master function of the System 21 is implemented. At a System 21 event (see also section 4.5) the master function draws the attention of the controller by asking service. The events are described in the System 21 manual which can be ordered with the reply card.

EX	RQS	AB	BSY	EF3	EF2	EF1	EF0
0	1	1	x	1	x	x	x

## Data available

If the PM2534 has made a measurement and has valid data which has not been output, it responds with:

EX	RQS	AB	BSY	EF3	EF2	EF1	EF0
0	1	0	1	x	x	x	1

## Waiting for a trigger command

If the instrument has sent the data to the interface and is waiting for a trigger command, the status byte will be the following: (BSY = 0)

EX	RQS	AB	BSY	EF3	EF2	EF1	EF0
0	1	0	0	x	x	x	1

The BSY (busy) bit will set after a trigger command has been received.

## Hold mode

With the Hold probe the Hold mode can be entered. The reading is "frozen" on that moment. The instrument responds with:

EX	RQS	AB	BSY	EF3	EF2	EF1	EF0
0	1	0	x	x	x	1	x

If the Hold mode is left by once more pushing the button on the Hold probe, the instrument asks again for service and responds with the following byte:

EX	RQS	AB	BSY	EF3	EF2	EF1	EF0
0	1	0	x	x	x	0	x

## 4.5 SYSTEM 21 MASTER FUNCTION

### 4.5.1 General

System 21 is a modular system consisting of a master and a number of independent functional units (slaves). It can be used in automatic test or measurements set-ups for auxiliary purposes, such as switch functions, I/O functions etc.

The main task of the master function is to pass data to the functional units. The communication between the external system and functional units is transparent. That means that the data is not affected during the transport from the external system to the functional unit and vice versa.

In the PM2534 a System 21 master function of System 21 is implemented. This means that a number of slave units (depending on the supply current, fuse protected max. 200 mA) can be connected to the PM2534.

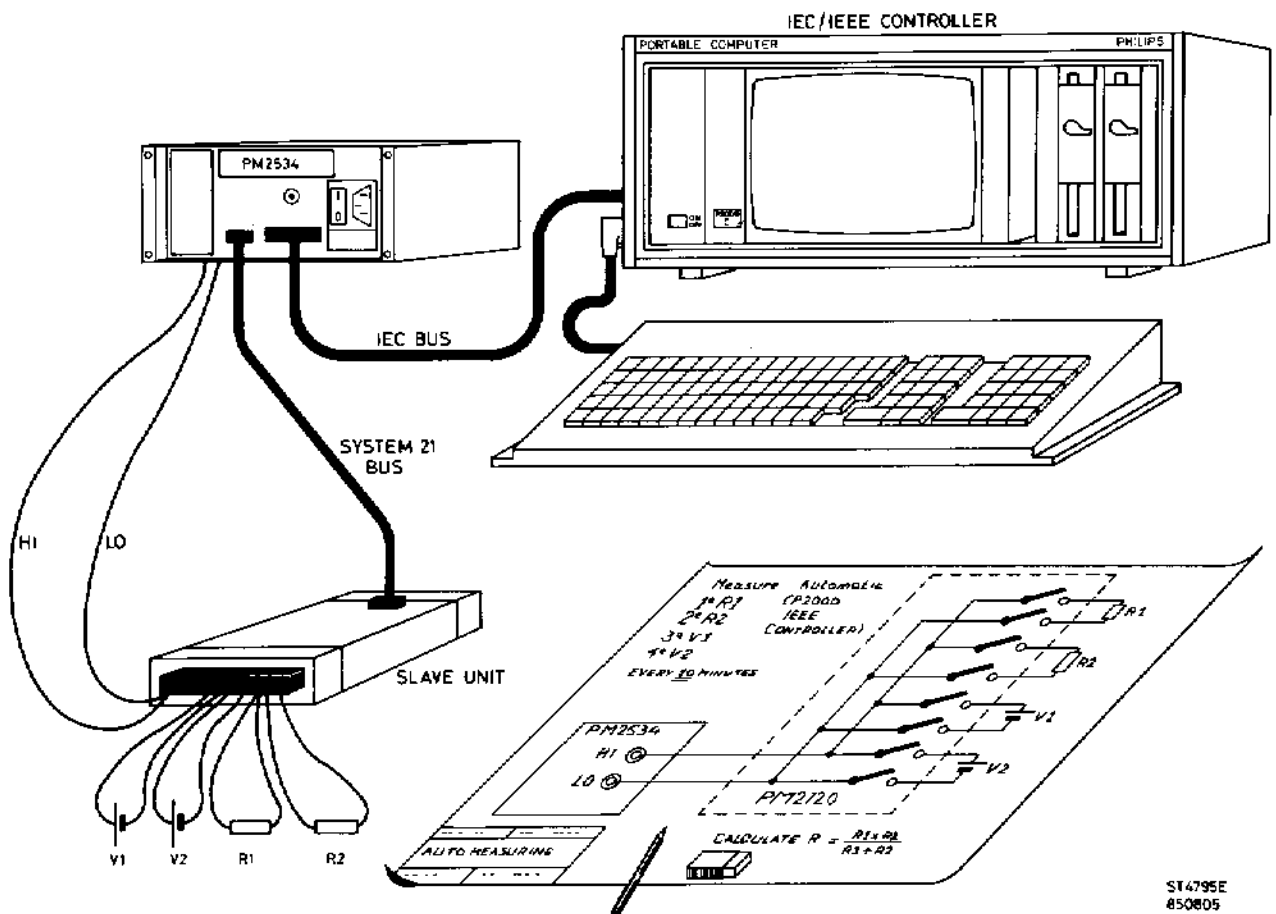

The System 21 commands are not handled here, but a full survey of the commands can be found in the Quick-operating guide delivered with the PM2534 and in the operating cards of the individual units (delivered with the units) for specific unit-dependent commands.

For full details of the System 21 refer to the System 21 manual which can be ordered with the reply card enclosed with this manual.

Remember that interface commands (such as service request masking, identity, etc) are only valid for the interface and will act as described in section 4.3.

#### 4.5.2 Contact assignment of System 21 connector

Pin number	Signal line
1	V +
2	data high
3	earth (shield)
4	ready
5	trigger
6	V -
7	data low
8	reset
9	V -

#### 4.5.3 Addressing a message

Any message to the PM2534 preceded by the IEEE/IEC address is set by the CHECK/END button. The routing of a message to the master or to one of the slave units, is indicated by the first element of the message, the unit address.

The unit address for the master is recognized by the characters AID.

(Additional Instrumentation Devices). So a command for the master is as follows:



ST4796E

A command intended for a slave must be preceded by the characters AID and 3 digits.

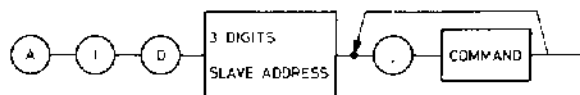

ST4797E

These 3 digits consist of the last two digits of the PM- number of the unit + 1 digit set on the unit address switch.

Separation between the unit address and the commands is achieved with ";" or ",". If more than one command is sent in one string, the individual commands need to be separated by commas.

To enable responses from System 21 part the command AID\_E has to be sent.

To disable responses from System 21 part the command AID\_D has to be sent.

#### 4.5.4 Commands

Commands are given in ASCII-coded form. There are two types of commands:

1. Commands for the master function.
2. Commands for individual units slaves.

A full summary is given overleaf of the System 21 master commands. Some of these commands request for return data.

Command	Description
Reset	
AID;RES	Reset the complete system to the power-on conditions.

Command	Description
<b>Trigger mode and commands to trigger or execute</b>	
AID;TRG_R	Trigger if Ready mode: enable the trigger-commands <u>GET</u> and "XCU T" only when ready is true or delay the received trigger command until ready becomes true.
AID;TRG_U	Trigger Unconditional mode: the trigger-commands <u>GET</u> and "XCU T" will unconditionally generate an impulse on the trigger-line.
AID;XCU_T AID;XCU nn	Execute the units by a pulse on the System 21 trigger-line if enabled. Execute all units with "PM21nn" numbers independent of the execution mode of the units. This command is useful when using I_S commands to perform a scan by more than one unit of the same type number.
<b>Read trigger mode</b>	
AID;TRG ?	Read current trigger mode Responses: AID;TRG R Trigger if ready mode AID;TRG U Trigger unconditional
<b>Sequential execution</b>	
SEQ_ON SEQ_OFF	Sequential execution. (SEQ ON) Parallel execution possible.
<b>Read sequential mode</b>	
AID;SEQ ?	Sequential execution ON or OFF ? Responses: AID;SEQ ON Sequential execution on. AID;SEQ OFF Sequential execution mode off.
<b>System 21 event masking</b>	
AID;MSK + <digits>	Mask System 21 events (maximum 9 "MSK 0" digits). A zero digit disables the corresponding event to generate a Service Request.  Digits 1 slave had a power fail or "0" received a power-on reset. A unit receives an illegal code or illegal sequence. 2 An addressed module is not present."0" 3 All units are ready performing "0" the programmed actions. 4 All units are ready with the "0" received data and may receive new data. 5 A unit has data available."0" 6 A unit is at the end of the block "0" or scan. 7 A unit has a warning."0" 8 The ready-line became high (ready "0" true). 9 A trigger-pulse was captured on "0" the trigger-line (not in PM2534).
<b>Read event mask</b>	
AID;MSK ?	Read current System 21 event mask.  Response: AID;MSK + <9 digits> Indicates which events set the abnormal bit (AB) together with the EF3 bit in the Serial Poll byte.



Command	Description
Request Configuration	
AID ?	Which unit addresses are present on System 21?
System 21 status	
AID;STA ?	Request System 21 Status.
	<p>Response: AID;STA + &lt;9 digits&gt;</p> <p>Digits</p> <p>1 Master received a power-on reset.</p> <p>2 The addressed unit was not present.</p> <p>3 A unit is busy.</p> <p>4 A unit is not ready with the received data.</p> <p>5 A unit has data available and should be read.</p> <p>6 A unit is at the end of a block or scan.</p> <p>7 A unit has a warning.</p> <p>8 The master saw the ready-line high; ready is true.</p> <p>9 The master captured a trigger pulse on the trigger-line (not available in PM2534).</p> <p>Digits 1, 2, 8 and 9 are cleared when read.</p> <p>A digit which is 0, indicates that the related message is not true.</p>
Read ready-line	
AID;RDY ?	<p>Logic state of the ready-line ? (RDY 1)</p> <p>Responses: AID;RDY 0 If ready-line is low (ready false)</p> <p>AID;RDY 1 If ready-line is high (ready true)</p>
Read trigger-mode	
AID;TRG ?	<p>Read actual trigger mode</p> <p>Responses: AID;TRG R Trigger if ready mode.</p> <p>AID;TRG U Trigger unconditional mode.</p>
Read programming of the master	
AID;DMP ?	<p>Ask for the programming data of the master</p> <p>Response: &lt;event mask&gt; + &lt;trigger mode&gt; + &lt;sequential mode&gt;</p>
End of block or scan	
AID;EOB ?	<p>Which units are at the End Of a Block</p> <p>Response: AID;EOB + &lt;addresses&gt; List of all units which are at the end of a block or a scan.</p>
Data available	
AID;DAV ?	<p>Which unit addresses have Data available</p> <p>Response: AID;DAV + &lt;addresses&gt;</p> <p>List of addresses of all units which (Example: AID;DAV 310,311,312,) have data available.</p>

4.3.2.5 Rear panel

TRIGGER  
BNC FOR EXTERNAL TRIGGER  
(FOR DATA REFER TO SECTION 4.3.3.1)

MAINS POWER UNIT  
- MAINS INPUT FOR 230 V 50 HZ  
FOR ADAPTATION TO 115 V REFER TO THE SERVICE MANUAL  
- MAINS FUSE 63 mA  
- POWER ON/OFF SWITCH

BLANK PANEL  
RESERVED FOR INPUT SOCKETS  
(REFER TO THE SERVICE MANUAL)

BLANK PANEL  
- RESERVED FOR OPTION

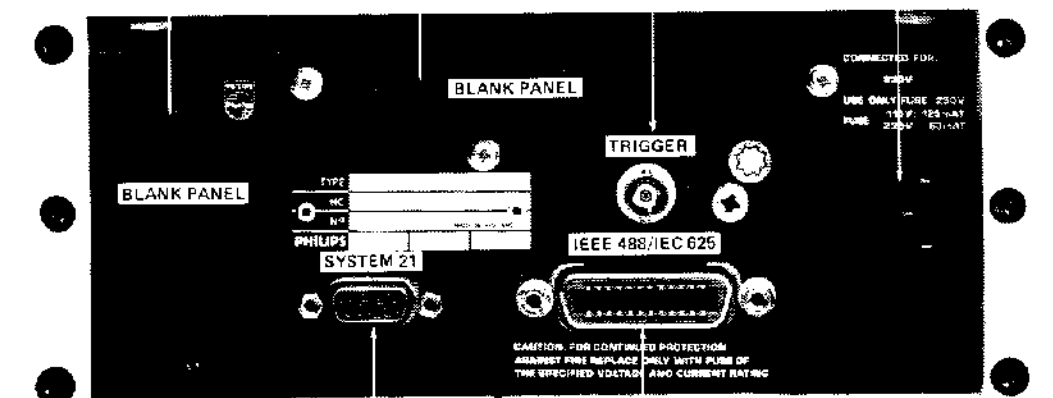

REAR PANEL

ST4847

SYSTEM 21  
CONNECTOR FOR SYSTEM 21  
(FOR INFO REFER TO : SECTION 4.5)

IEEE - 488/IEC - 625  
CONNECTOR FOR IEEE - 488/IEC - 625 INTERFACE  
(FOR INFO REFER TO SECTION 4.4 AND INSTRUCTION CARD)

4.3.3 Specific modes

4.3.3.1 Function selection

With the function keys the various functions can be selected. The relevant function is also indicated on the display

FUNCTION						
V <sub>~</sub>	V <sub>~</sub>	Q2W	Q4W	A <sub>~</sub>	A <sub>~</sub>	SC
<input type="checkbox"/>	<input type="checkbox"/>	<input type="checkbox"/>	<input type="checkbox"/>	<input type="checkbox"/>	<input type="checkbox"/>	<input type="checkbox"/>

ST4847

4.3.3.2 Ranging

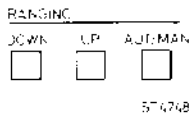

Manual or automatic ranging is available for all functions (except °C). Selection between the modes can be made by pressing the AUT/MAN pushbutton. Manual ranging is indicated with M RNG on the display.

To range proceed as follows:

Example 200.00 mV---

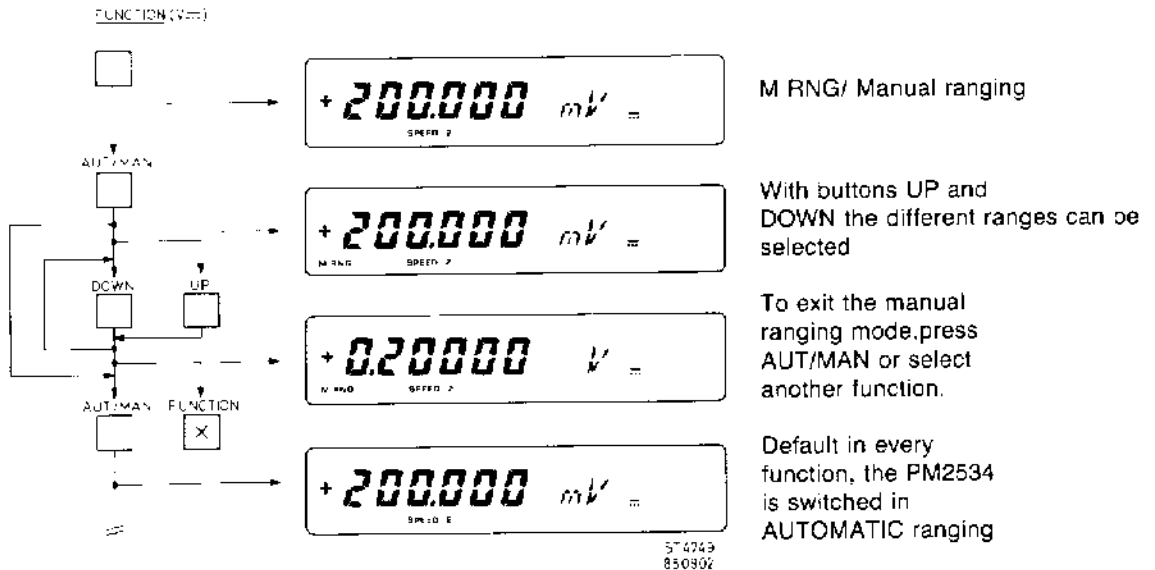

- Auto
- UP ranging at >300000 dig.
  - DOWN ranging at. ≤27000 dig.

To eliminate the hysteresis in the automatic range selection, a higher or lower range can be selected by means of the Up - Down switch.

4.3.3.3 Trigger

The trigger mode is divided into two trigger modes:

- Internal trigger mode

A measurement is started automatically after completing a previous one.

- Single trigger mode

A measurement can be started:

\* Manual:

Pressing the SINGLE pushbutton performs one measurement. (In the automatic ranging mode first, if necessary, the correct range is selected and the new measurement is performed and displayed).

\* External:

- Via the the TRIGGER BNC connector at the rear of the PM2534. A measurement is started by making this input low.

*Note: The EXT start input is galvanically separated from the measuring circuit.*

- Via the IEC-625/IEEE-488 bus interface (see section 4.4.5.6).

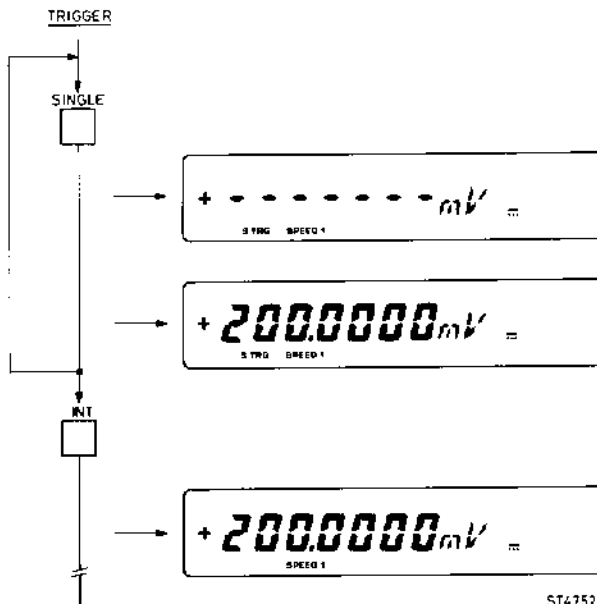
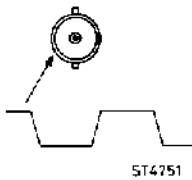
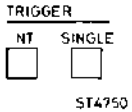

Remarks: In single trigger mode after any function change, ----- will appear on the display.

4.3.3.4 Speed

The speed button selects the measuring speeds. In the display, speeds 1,2,3 or 4 are indicated.

Dependent on the function, the measuring speed, the resolution and the display length are determined by the instrument.

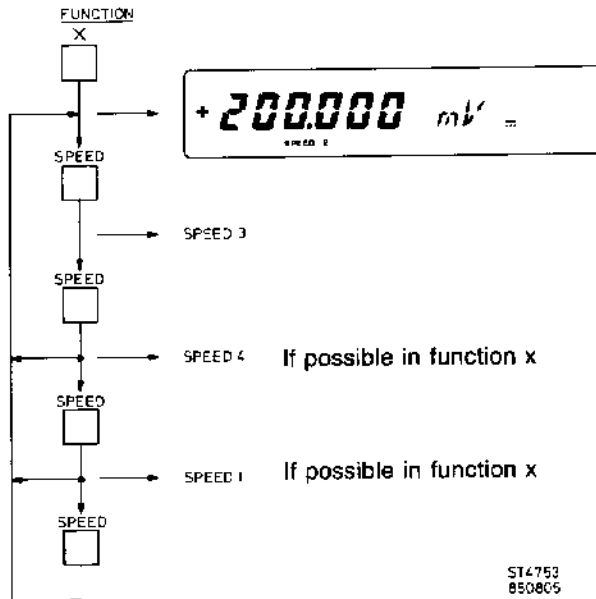

ST4753  
850805

The possibilities are as follows.

Function	Speed	Ranges	Speed meas/s up to	Display length up to	
V <sub>DC</sub>	1	all	0.3	3000000	
	2	all	3	300000	
	3	all	30	30000	
	4	all	100	3000	
V <sub>~</sub>	2	all	3	30000	
	3	all	30	3000	
	Ω 2-,4-wire	1	3 kΩ-3 MΩ	0.3	3000000
			30 MΩ	0.3	300000
300 MΩ			0.3	30000	
2		3 kΩ-3 MΩ	3	300000	
	30 MΩ	3	30000		
	300 MΩ	3	3000		
3	3 kΩ-3 MΩ	30	30000		
	30 MΩ	30	3000		
	300 MΩ	30	300		
4	3 kΩ-300 kΩ	65	3000		
A <sub>DC</sub>	2	all	3	300000	
	3	all	30	30000	
	4	all	100	3000	
A <sub>~</sub>	2	all	3	30000	
	3	all	30	3000	
°C	2	all		3000	
	3	all		300	

Remarks - Stated measuring speed excludes the time needed by the IEEE/IEC controller to perform the handshake.

It is valid for a 50 Hz version.

In speed 1, the display value will be updated within 0.5 s after a step change of the input signal.

4.3.3.5 Filter

The front-panel Filter pushbutton brings a filter into circuit, indicated in the display as FILT. There are two possibilities:

1. Digital filter in the functions  $V_{\text{---}}$ ,  $A_{\text{---}}$ ,  $\Omega$ -2 wire and  $\Omega$ -4 wire. If the filter is switched on in these functions, the display result is determined by the following formula:

$$\text{display result} = 0,8 \times \text{previous result} + 0,2 \times \text{actual measurement.}$$

If the difference between the actual measurement and the previous result is too big, then the display result is equal to the actual result.

When one of the above mentioned functions is selected the filter will always be in the off state.

2. In the function  $V_{\sim}$  and  $A_{\sim}$  the bottom of the measurable frequency range is shifted from 40 Hz (filter on) to 400 Hz (filter off). If filter off is selected the response time of the different ranges is decreased. When  $V_{\sim}$  or  $A_{\sim}$  is selected, the filter will always be in the on state (40 Hz).

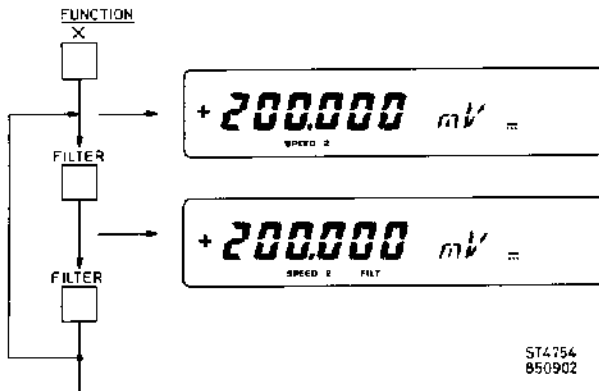

ST4754  
850902

4.3.3.6 Null

The function can be switched on/off for zero-point correction to compensate offset and thermal voltages of max. 1000 digits in the 300 mV dc range. To compensate offset and thermal voltage short-circuit the input with the measuring leads (recommended cable: shielded low thermal voltage cable PM9265/01). Pushing Null will automatically select speed 1 to obtain the Null value. The function is indicated in the display as NULL and is only active for speeds 1, 2 and 3 in the 300 mV dc range.

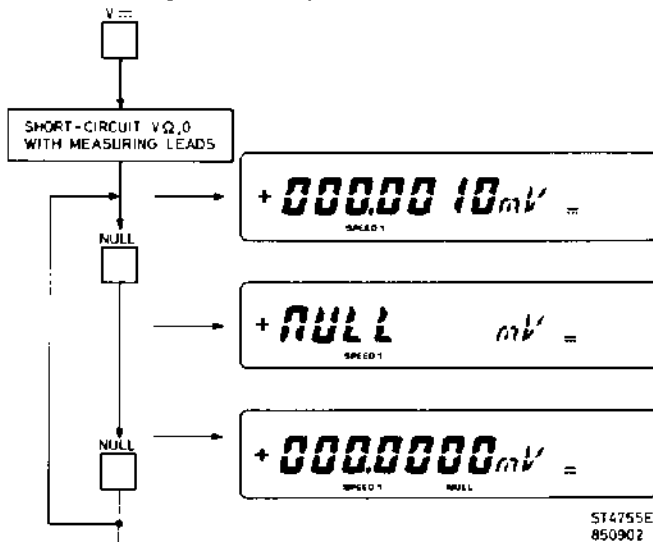

If <1000 digits  
Null is refreshed.  
The stored value is  
subtracted from the  
measured value

ST4755E  
850902

Note: After Power On the function is not activated. However, once activated the function is kept in memory even if the function is changed. Selecting  $V_{\text{---}}$  again will switch on the Null function.

**CONTENTS**

Page

<b>1. OPERATOR SAFETY</b>	<b>1-1E</b>
1.1 General information .....	1-1E
1.2 Safety precautions .....	1-1E
1.3 Caution and warning statements .....	1-1E
1.4 Symbols .....	1-1E
1.5 Impaired safety protection .....	1-1E
<b>2. GENERAL INFORMATION</b>	<b>2-1E</b>
2.1 Introduction .....	2-1E
2.2 Characteristics .....	2-1E
2.2.1 Safety characteristics .....	2-1E
2.2.2 Performance characteristics .....	2-2E
2.2.3 V <sub>dc</sub> .....	2-2E
2.2.4 V <sub>ac</sub> .....	2-4E
2.2.5 Resistance .....	2-5E
2.2.6 I <sub>dc</sub> .....	2-7E
2.2.7 I <sub>ac</sub> .....	2-8E
2.2.8 Temperature .....	2-10E
2.2.9 Converter characteristics .....	2-10E
2.2.10 Time function .....	2-11E
2.2.11 Input terminal arrangement .....	2-11E
2.3 Operational data .....	2-12E
2.3.1 Display .....	2-12E
2.3.2 IEC/IEEE interface .....	2-13E
2.3.3 System 21 interface .....	2-13E
2.3.4 External control .....	2-13E
2.4 Environmental conditions .....	2-13E
2.4.1 Climatic conditions .....	2-13E
2.4.2 Mechanical conditions .....	2-14E
2.4.3 Line supply conditions .....	2-14E
2.4.4 Power consumption .....	2-14E
2.4.5 Accessories .....	2-14E
<b>3. INSTALLATION INSTRUCTIONS</b>	<b>3-1E</b>
3.1 Initial inspection .....	3-1E
3.2 Safety instructions .....	3-1E
3.2.1 Earthing (grounding) .....	3-1E
3.2.2 Mains voltage setting and fuses .....	3-1E
3.3 Operating position of the instrument .....	3-2E
3.4 19-Inch rack-mounting .....	3-2E

<b>4. OPERATING INSTRUCTIONS</b>	<b>4-1E</b>
4.1 General information	4-1E
4.2 Switching-on	4-1E
4.3 Manual operation	4-1E
4.3.1 General information	4-1E
4.3.2 Front rear panel	4-2E
4.3.2.1 Display	4-2E
4.3.2.2 Keyboard	4-3E
4.3.2.3 Inputs	4-4E
4.3.2.4 GUARD usage	4-4E
4.3.2.5 Rear panel	4-5E
4.3.3 Specific modes	4-5E
4.3.3.1 Function selection	4-5E
4.3.3.2 Ranging	4-6E
4.3.3.3 Trigger	4-7E
4.3.3.4 Speed	4-8E
4.3.3.5 Filter	4-9E
4.3.3.6 Null	4-9E
4.3.3.7 Check/end	4-10E
4.3.3.8 Reset	4-10E
4.3.3.9 Cal	4-10E
4.3.4 Measuring functions	4-11E
4.3.4.1 Direct voltage measurements	4-11E
4.3.4.2 Alternating voltage measurements	4-12E
4.3.4.3 Resistance two-wire measurements	4-13E
4.3.4.4 Resistance four-wire measurements	4-14E
4.3.4.5 Direct current measurements	4-15E
4.3.4.6 Alternating current measurements	4-16E
4.3.4.7 Temperature measurements	4-17E
4.3.4.8 Clipping- Crest- factor indication	4-17E
4.4 IEC-625/IEEE-488 interface	4-18E
4.4.1 General	4-18E
4.4.2 Specifications	4-18E
4.4.2.1 Functional specification	4-18E
4.4.2.2 Code specification	4-18E
4.4.2.3 Connector pinning	4-19E
4.4.2.4 Timing specification	4-20E
4.4.2.5 Switch specification	4-21E
4.4.3 Programming the PM2534	4-22E
4.4.3.1 General information	4-22E
4.4.4 Interface programming	4-22E
4.4.4.1 Interface program data	4-23E
4.4.4.2 Sending program data	4-23E
4.4.4.3 Service request mask	4-24E
4.4.4.4 Separators	4-25E
4.4.4.5 Identity	4-25E
4.4.4.6 Interface test	4-25E



4.4.5	Device programming	4-26E
4.4.5.1	Function selection	4-26E
4.4.5.2	Range selection	4-27E
4.4.5.3	Measuring Speed/Resolution	4-28E
4.4.5.4	Filter	4-29E
4.4.5.5	Trigger modes	4-29E
4.4.5.6	Internal settling time	4-30E
4.4.5.7	Delay	4-30E
4.4.5.8	Start command	4-31E
4.4.5.9	Display mode	4-31E
4.4.5.10	Output mode	4-32E
4.4.5.11	Null	4-33E
4.4.5.12	System 21 mode	4-33E
4.4.5.13	Survey of commands	4-34E
4.4.6	Calibration via the controller	4-35E
4.4.7	Selfdiagnostics via the controller	4-35E
4.4.8	Output data	4-36E
4.4.8.1	Measuring data	4-36E
4.4.8.2	Dump	4-37E
4.4.8.3	Output of settings	4-38E
4.4.8.4	Device status data	4-39E
4.4.8.5	Identity	4-40E
4.4.8.6	Interface test	4-40E
4.4.9	Reasons for service request	4-40E
4.5	System 21 master function	4-42E
4.5.1	General	4-42E
4.5.2	Contact assignment of System 21 connector	4-43E
4.5.3	Addressing a message	4-43E
4.5.4	Commands	4-43E

## APPENDIX A

A-1

## APPENDIX B

B-1

9. CIRCUIT DIAGRAMS AND PRINTED CIRCUIT BOARDS LAY-OUTS

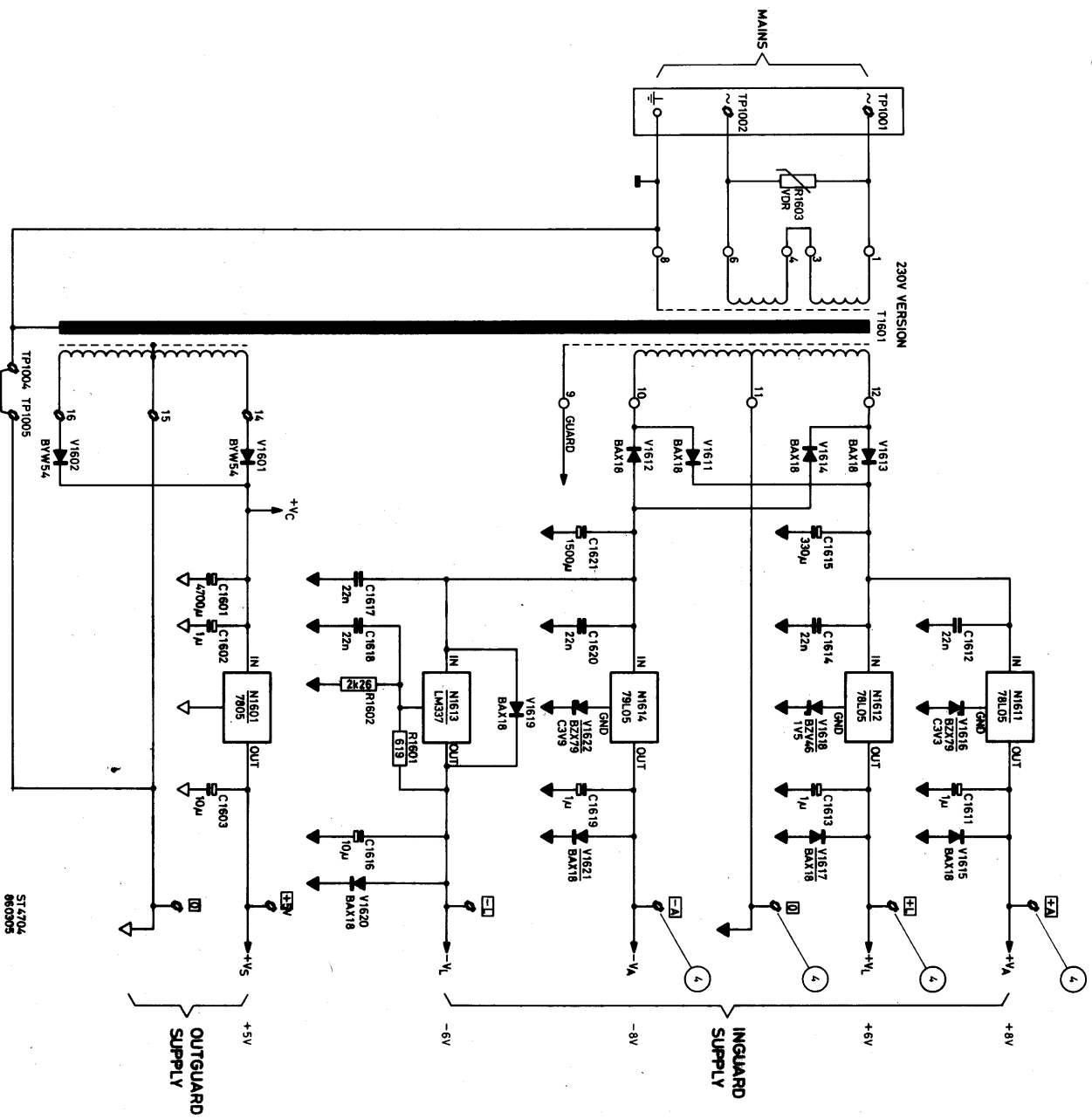
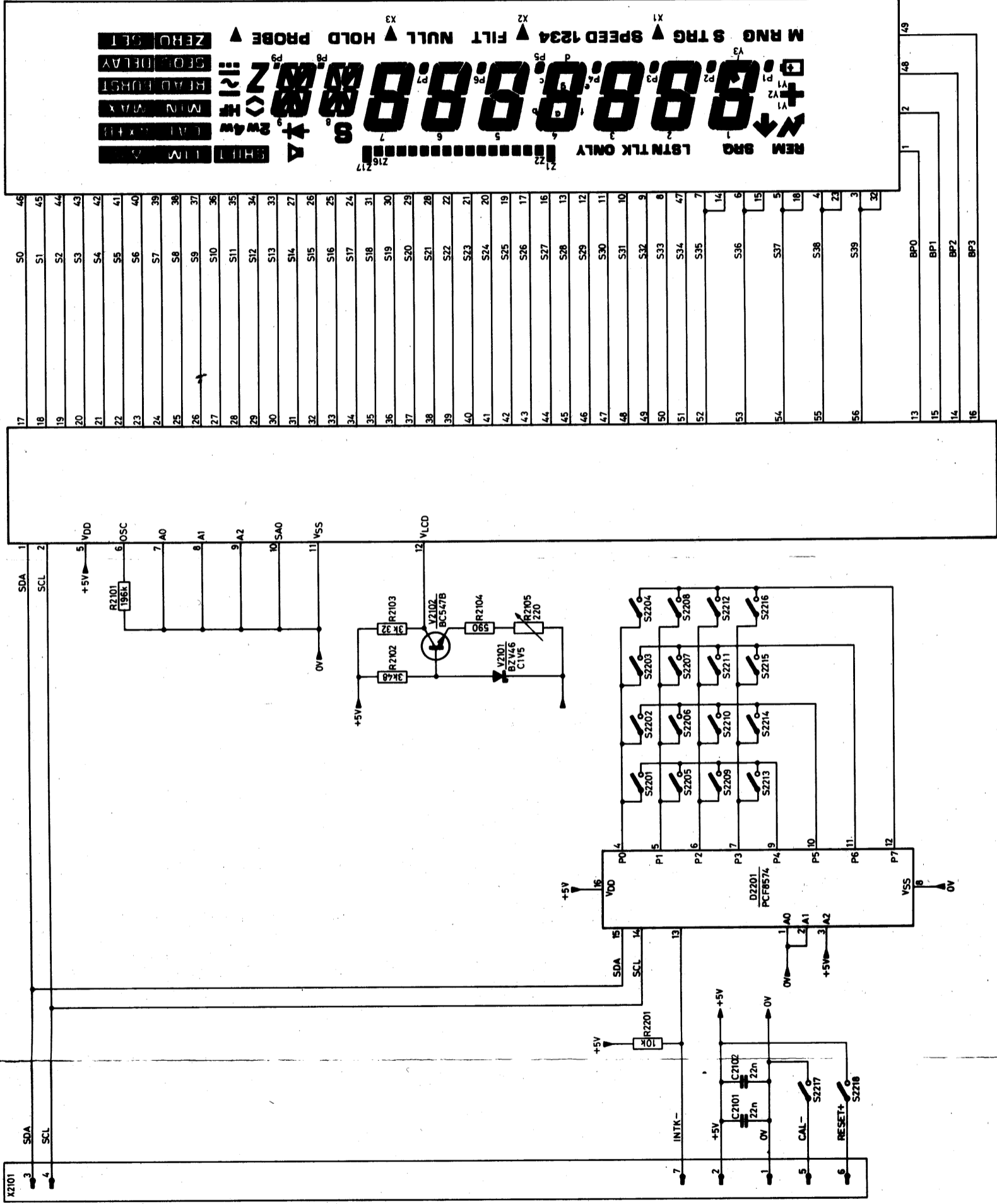
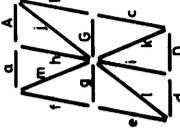

Figure 9.1 Power supply



LX DISPLAY

MSB	LSB	MS NIBBLE	LS NIBBLE
S0	---	DELAY	SEQU
S1	BURST	MAX Δ%	AX+B
S2	READ	MIN LIM	CAL
S3	---	4W	SHIFT
S4	---	HF	2W
S5	PBP9	Z	^
S6	D9	c9	A9
S7	k8	G9	H9
S8	19	19	m9
S9	d9	e9	o9
S10	D8	c8	A8
S11	k8	G8	H8
S12	18	18	m8
S13	d8	e8	o8
S14	Z14	Z15	Z17
S15	Z13	Z12	Z10
S16	Z6	Z7	Z9
S17	Z5	Z4	Z2
S18	d7	c7	a7
S19	P7	e7	17
S20	d6	c6	a6
S21	P6	e6	16
S22	d5	c5	a5
S23	P5	e5	15
S24	d4	c4	a4
S25	P4	e4	14
S26	d3	c3	a3
S27	P3	e3	13
S28	d2	c2	a2
S29	P2	e2	12
S30	d1	c1	a1
S31	Y3	e1	11
S32	P2	Y2	SRQ
S33	---	Y1	REM
S34	---	---	SET ZERO
S35	X1	S TRG	LSTN MRNG
S36	SPEED	1	TLK
S37	X2	4	ONLY
S38	FILT	NULL	Z1
S39	X4	PROBE	S



ST4705  
860429

Figure 9.2 Display

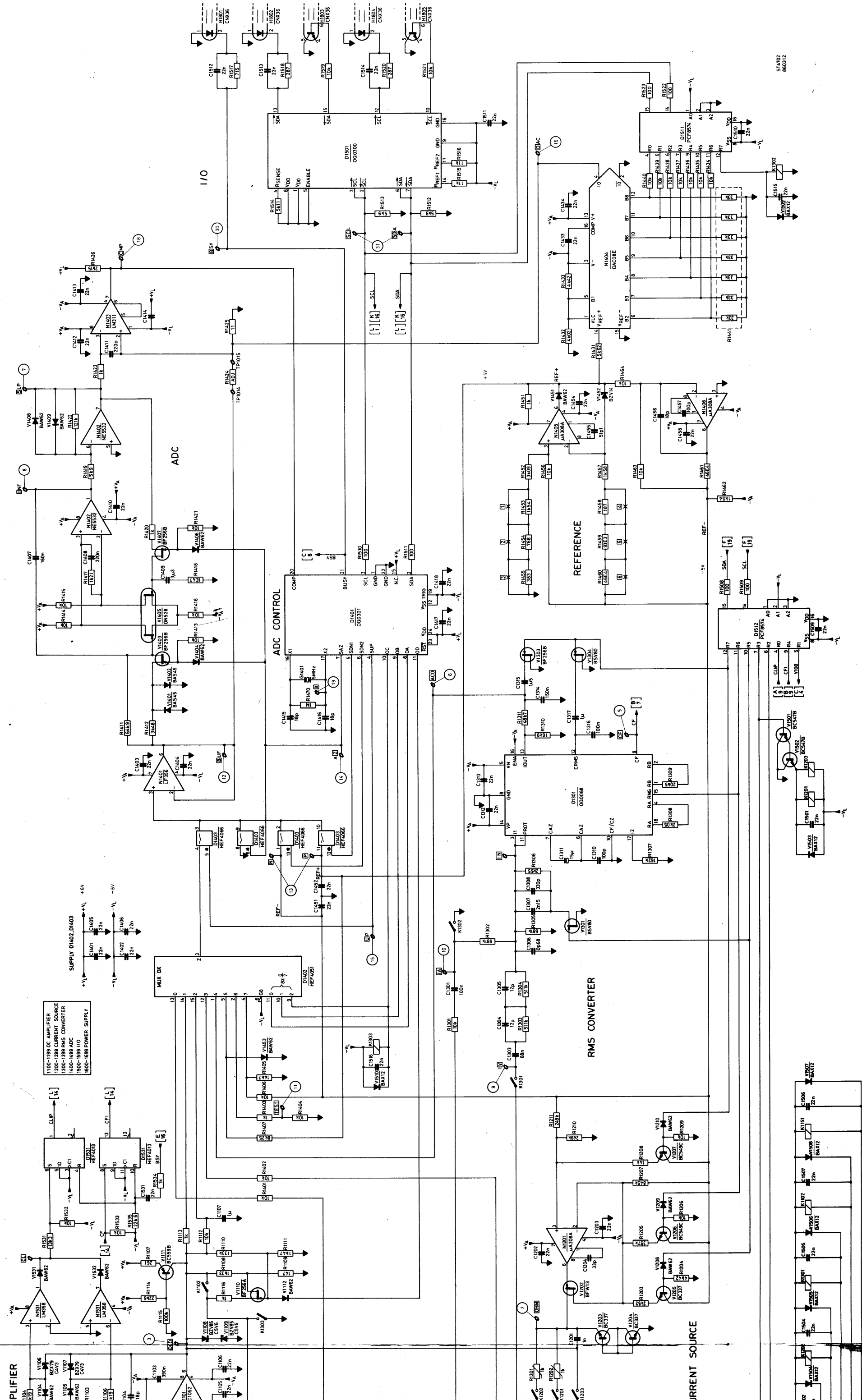

- 1100-1199 DC AMPLIFIER
- 1200-1299 CURRENT SOURCE
- 1300-1399 RMS CONVERTER
- 1400-1499 ADC
- 1500-1599 I/O
- 1600-1699 POWER SUPPLY

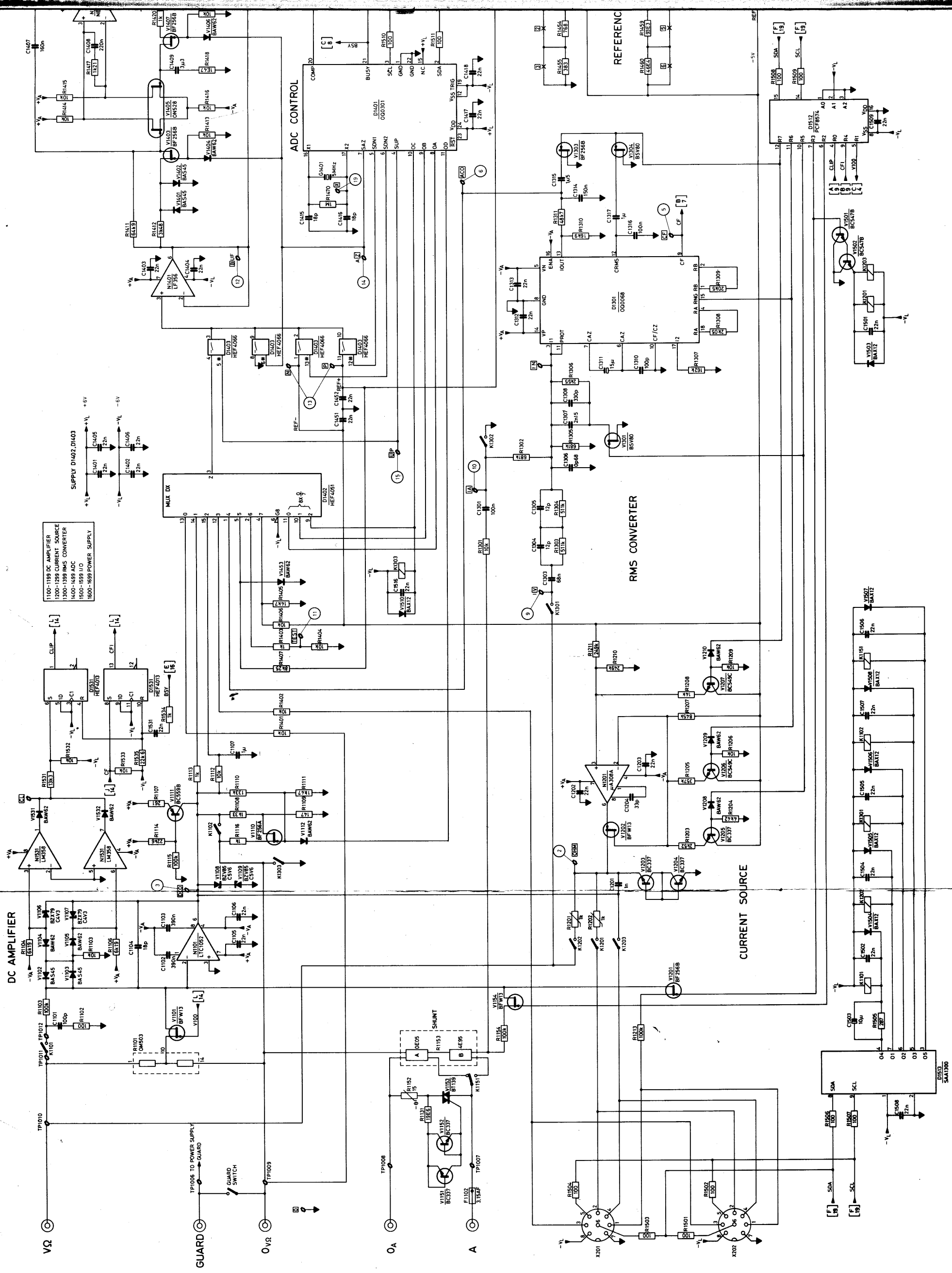
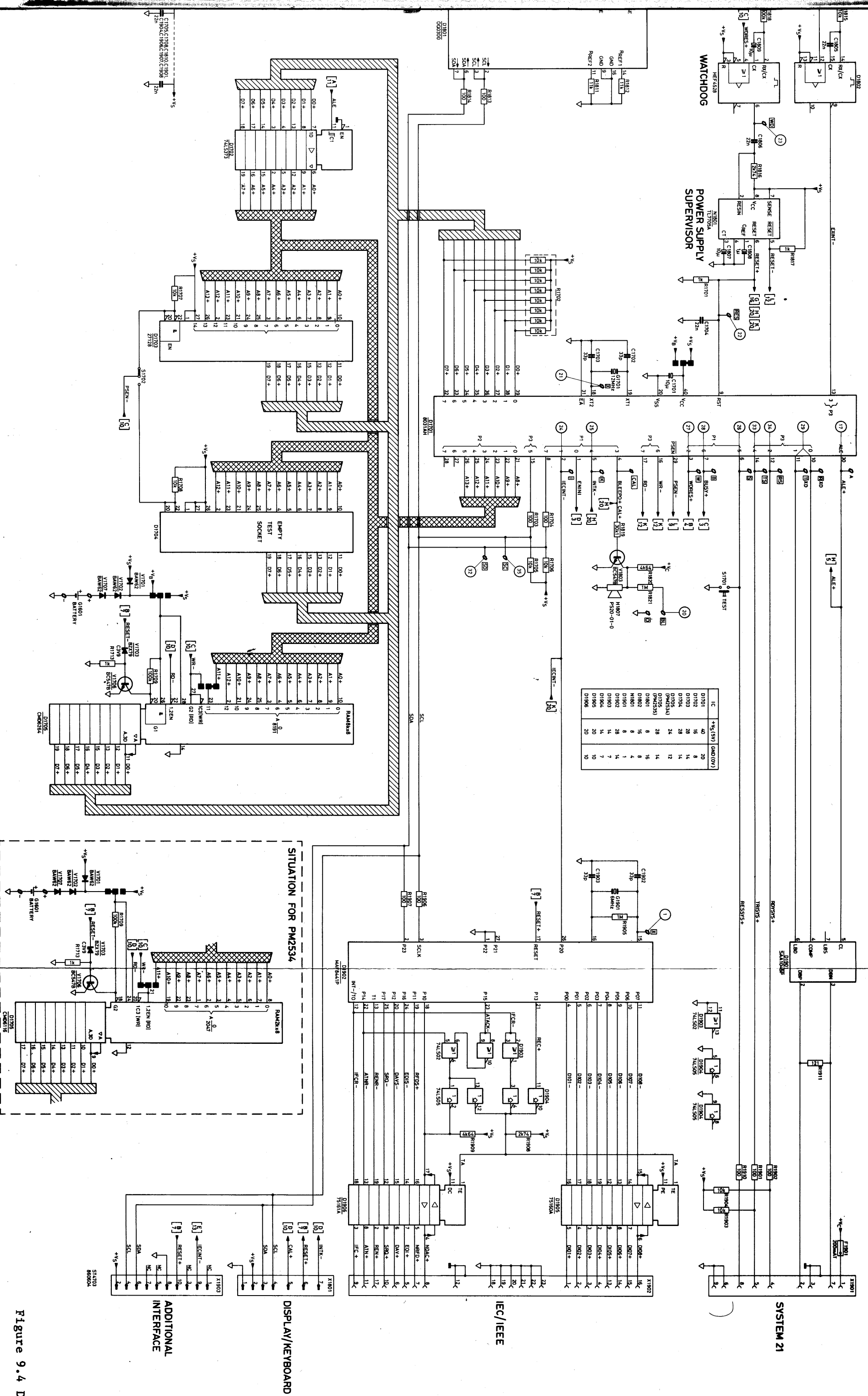
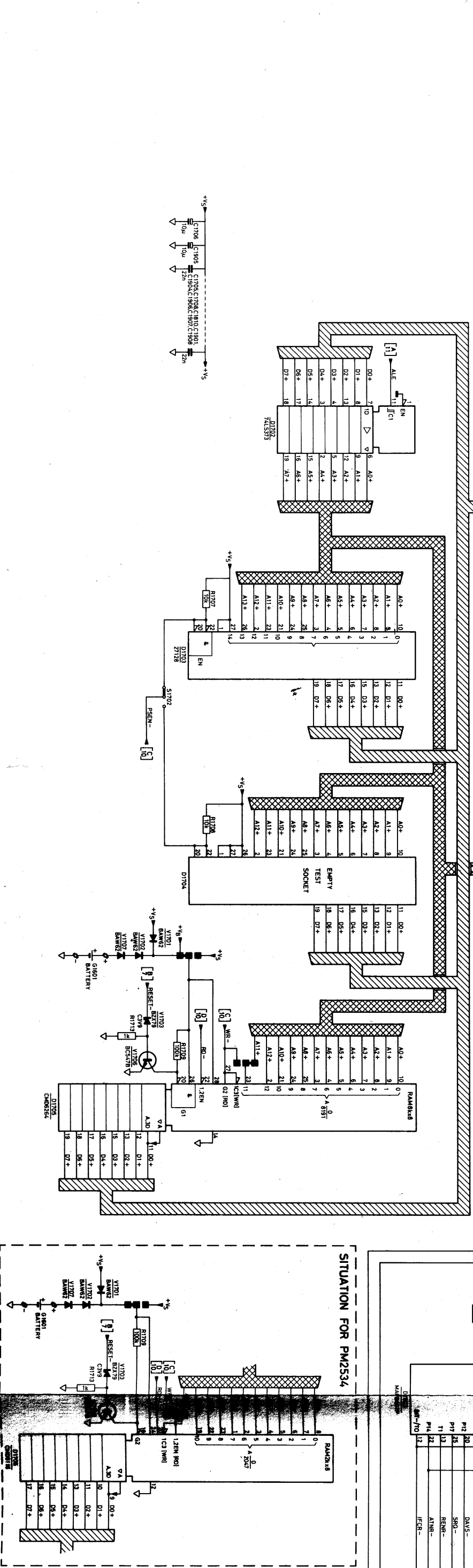
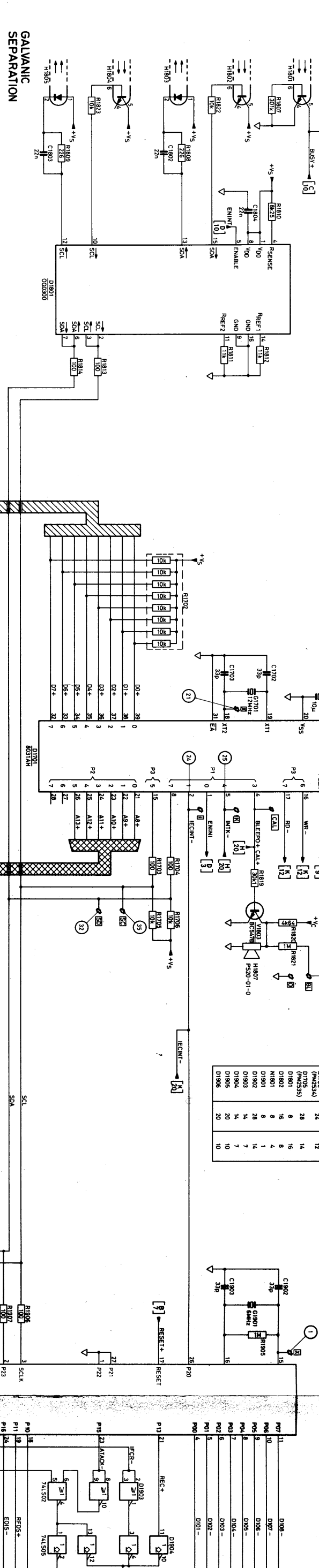
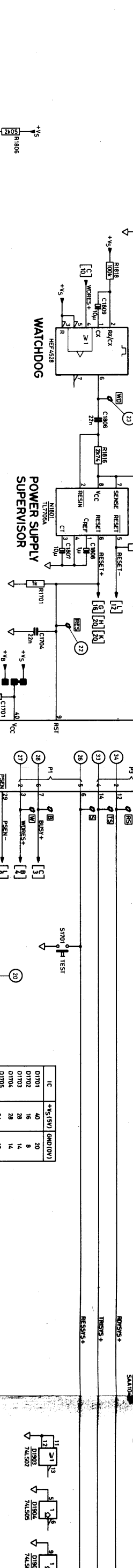
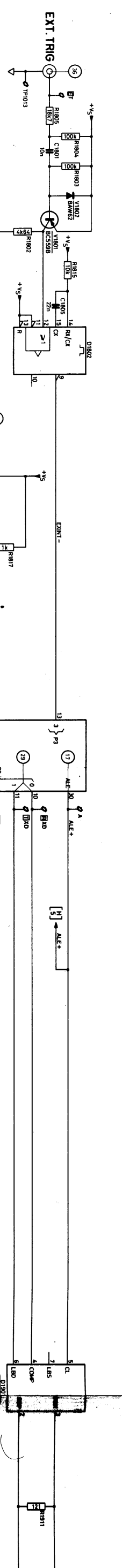

Figure 9.3 Analog



IC	IC	IC	IC	IC	IC	IC	IC	IC	IC
D1701	40	D1702	16	D1703	8	D1704	14	D1705	12
D1706	28	D1707	14	D1708	14	D1709	14	D1710	14
D1711	24	D1712	12	D1713	14	D1714	14	D1715	14
D1716	28	D1717	12	D1718	14	D1719	14	D1720	14
D1721	24	D1722	12	D1723	14	D1724	14	D1725	14
D1726	28	D1727	12	D1728	14	D1729	14	D1730	14
D1731	24	D1732	12	D1733	14	D1734	14	D1735	14
D1736	28	D1737	12	D1738	14	D1739	14	D1740	14
D1741	24	D1742	12	D1743	14	D1744	14	D1745	14
D1746	28	D1747	12	D1748	14	D1749	14	D1750	14
D1751	24	D1752	12	D1753	14	D1754	14	D1755	14
D1756	28	D1757	12	D1758	14	D1759	14	D1760	14
D1761	24	D1762	12	D1763	14	D1764	14	D1765	14
D1766	28	D1767	12	D1768	14	D1769	14	D1770	14
D1771	24	D1772	12	D1773	14	D1774	14	D1775	14
D1776	28	D1777	12	D1778	14	D1779	14	D1780	14
D1781	24	D1782	12	D1783	14	D1784	14	D1785	14
D1786	28	D1787	12	D1788	14	D1789	14	D1790	14
D1791	24	D1792	12	D1793	14	D1794	14	D1795	14
D1796	28	D1797	12	D1798	14	D1799	14	D1800	14

Figure 9.4 Digital



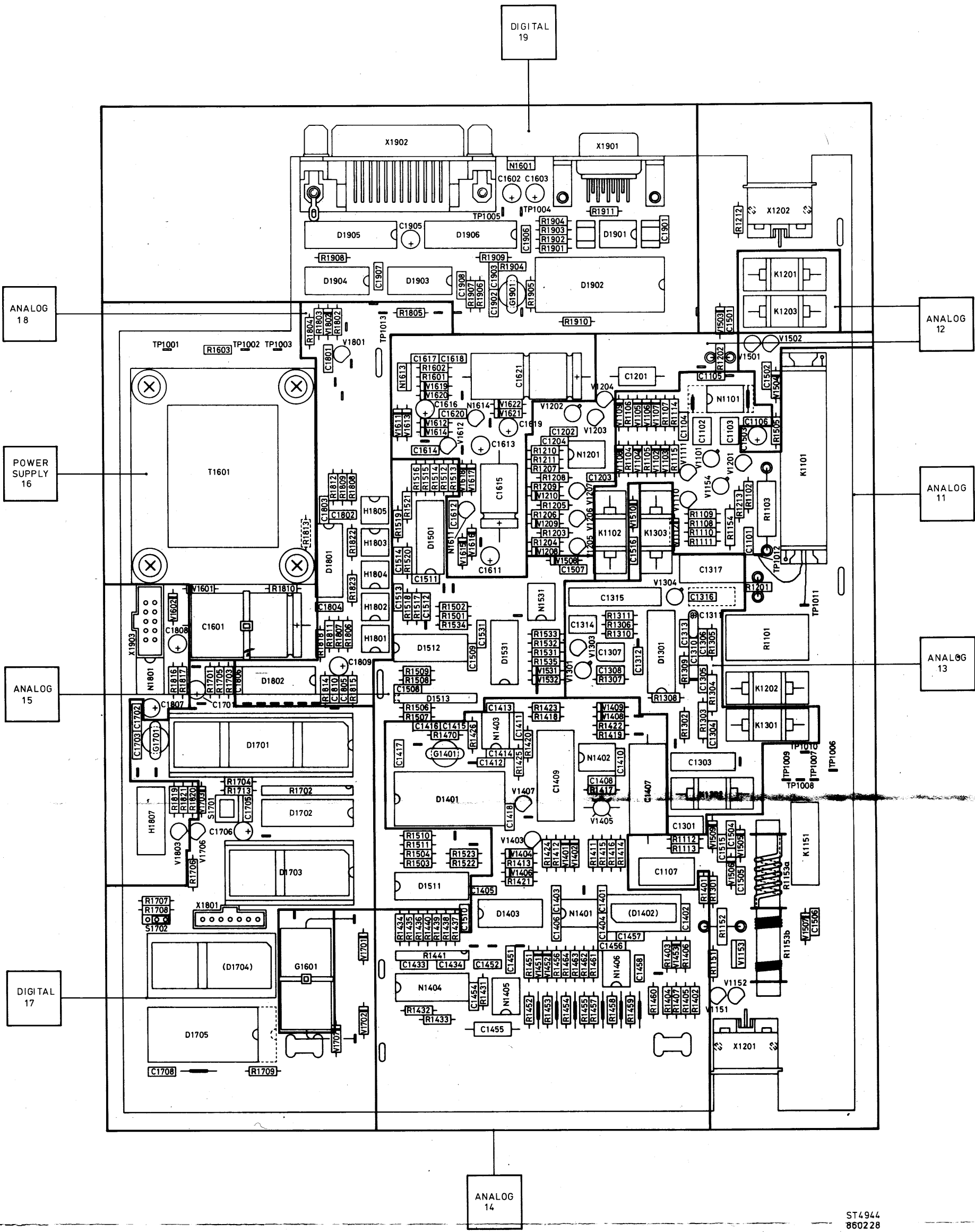

ST4944  
860228

Figure 9.5 Parts Location



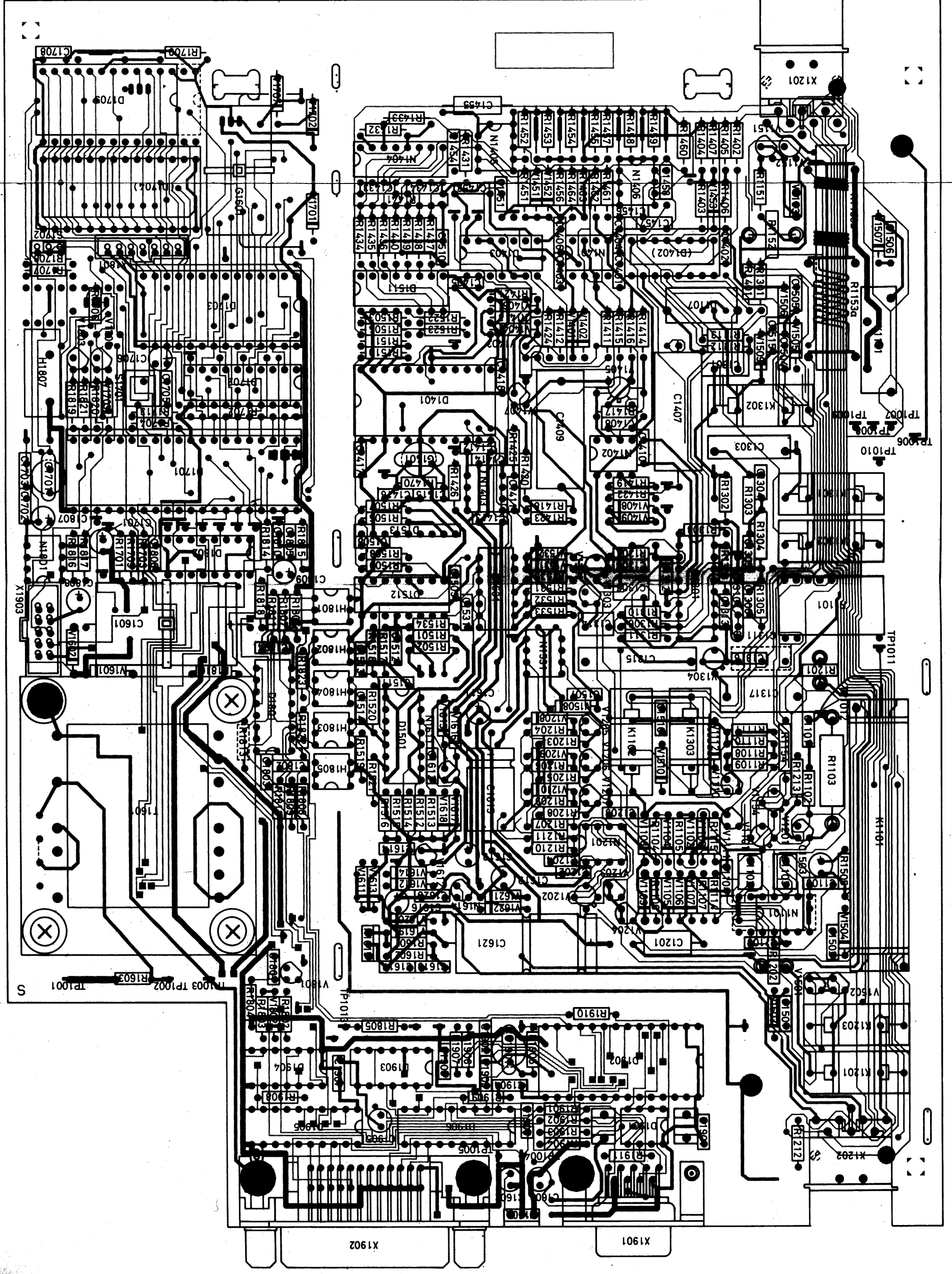
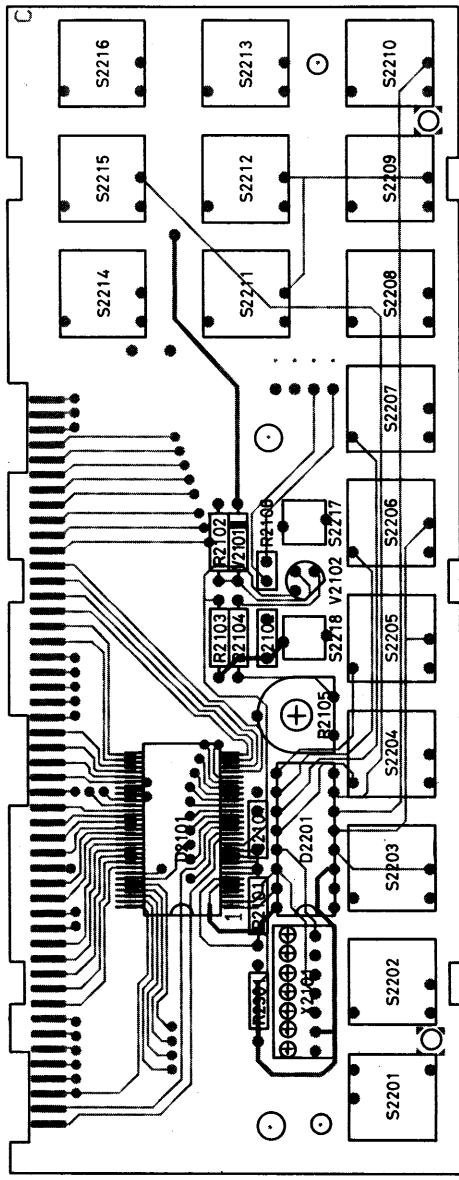
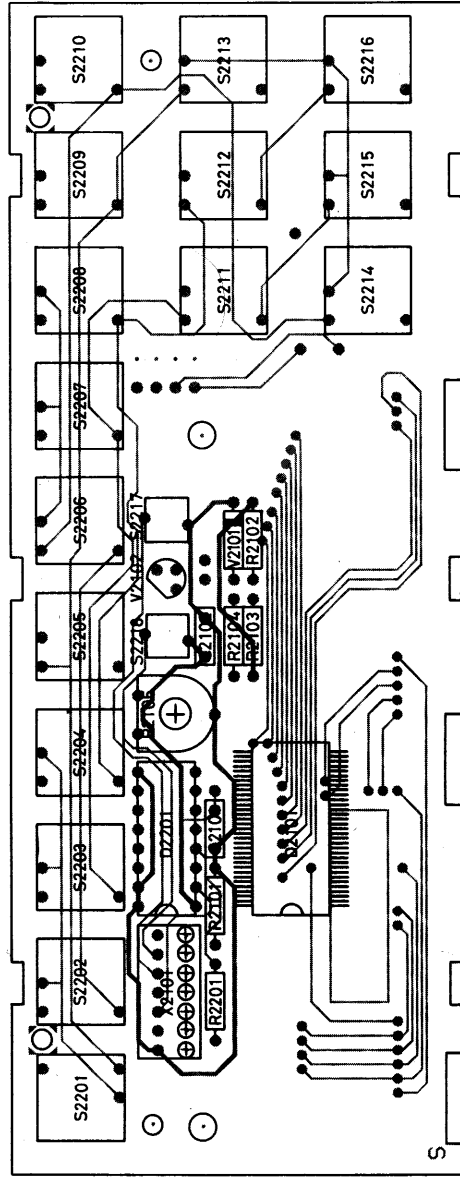

Figure 9.7 Main pcb, conductor side



ST4739  
850809

Figure 9.8 Display pcb, component side



ST4801  
860305

Figure 9.9 Display pcb, conductor side

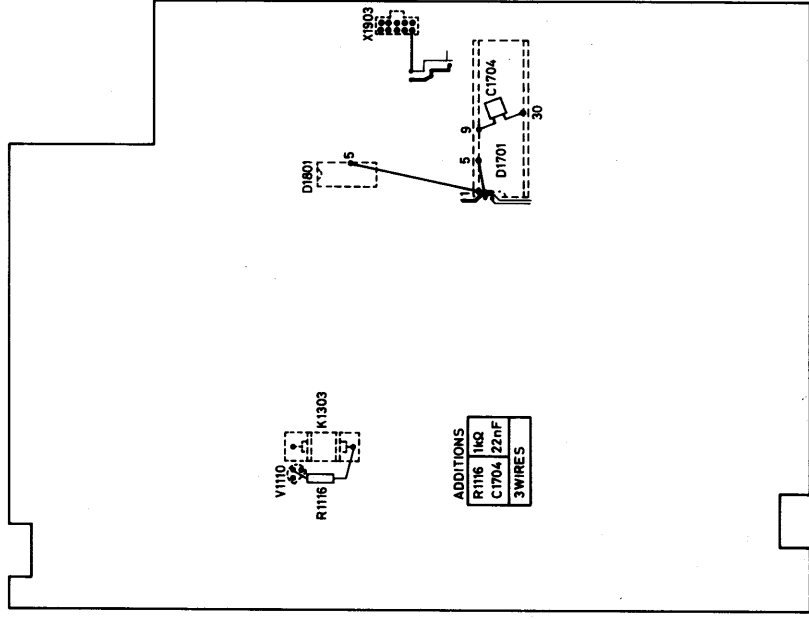

ST4984  
860429

Figure 9.10 Additional components conductor side main pcb (PM2534 version)

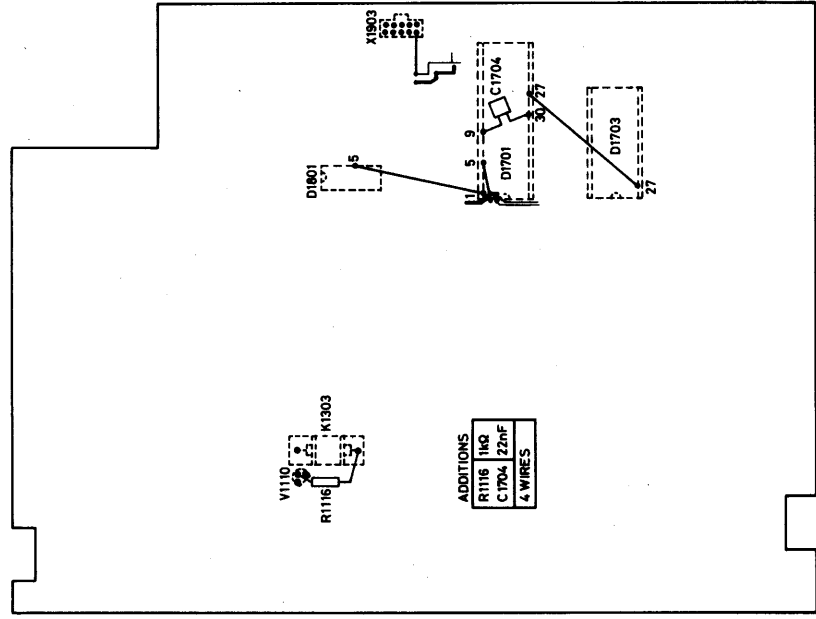

ST4985  
860429

Figure 9.11 Additional components conductor side main pcb (PM2535 version)