

VISIBLE LIGHT PRODUCTS SPECIFICATION

HPR40E-19K100xWHAx



High Power 100W LED

Drawn by	Checked by	Approved by



DATE:2012/4/10

REV:B



HUEY JANN ELECTRONICS INDUSTRY CO., LTD.

No.27 Line 466 Sec.2,Cannng-nan Rd. Wu-chi Town Taichung Shien, Taiwan, R.O.C.

TEL:+886-4-26393976 FAX:+886-4-26393125

HUEY JANN High Power 100W LED is made of hi-eff AS/TS GaInN chips with precise package technique which makes excellent heat dissipation to reach the advantages of high luminous efficiency, low decay, and long endurance. Now we have these colors available: red, green, blue, white, yellow .

FEATERUS

- Instant light
- Long operating life
- Superior ESD defense
- Low voltage DC operated
- More energy efficient than incandescent and most halogen lamps

TYPICAL APPLICATIONS

- Architectural detail lighting
- Portable flashlight
- Reading lights
- Medical applications
- LCD backlights
- Beacon lights
- Decoration lights



HUEY JANN ELECTRONICS INDUSTRY CO., LTD.

No.27 Line 466 Sec.2,Cannng-nan Rd. Wu-chi Town Taichung Shien, Taiwan, R.O.C.

TEL:+886-4-26393976 FAX:+886-4-26393125

Explanation of Part Number:

H P R 40 E - 1 9K 100 xWHAx

① ② ③ ④ ⑤ ⑥ ⑦ ⑧ ⑨

1.H: Huey Jann

2.P: High power LED Type

3.Shape distinguish:

4.Identification no:

R: Reflector type

5.Lead frame type

6.Lens appearance:

1:White Diffusion

7.Color number:

8.Power type:

3K: Green 4K: Yellow
5K: Red 8K: Blue
9K: White

50: 50W
100: 100W

9.Color kind:

BWHA: Cool White
WHA: Pure White
NWA: Nature White
YWHA: Warm White



HUEY JANN ELECTRONICS INDUSTRY CO., LTD.

No.27 Line 466 Sec.2,Cannng-nan Rd. Wu-chi Town Taichung Shien, Taiwan, R.O.C.

TEL:+886-4-26393976 FAX:+886-4-26393125

PACKAGE DIMENSIONS:

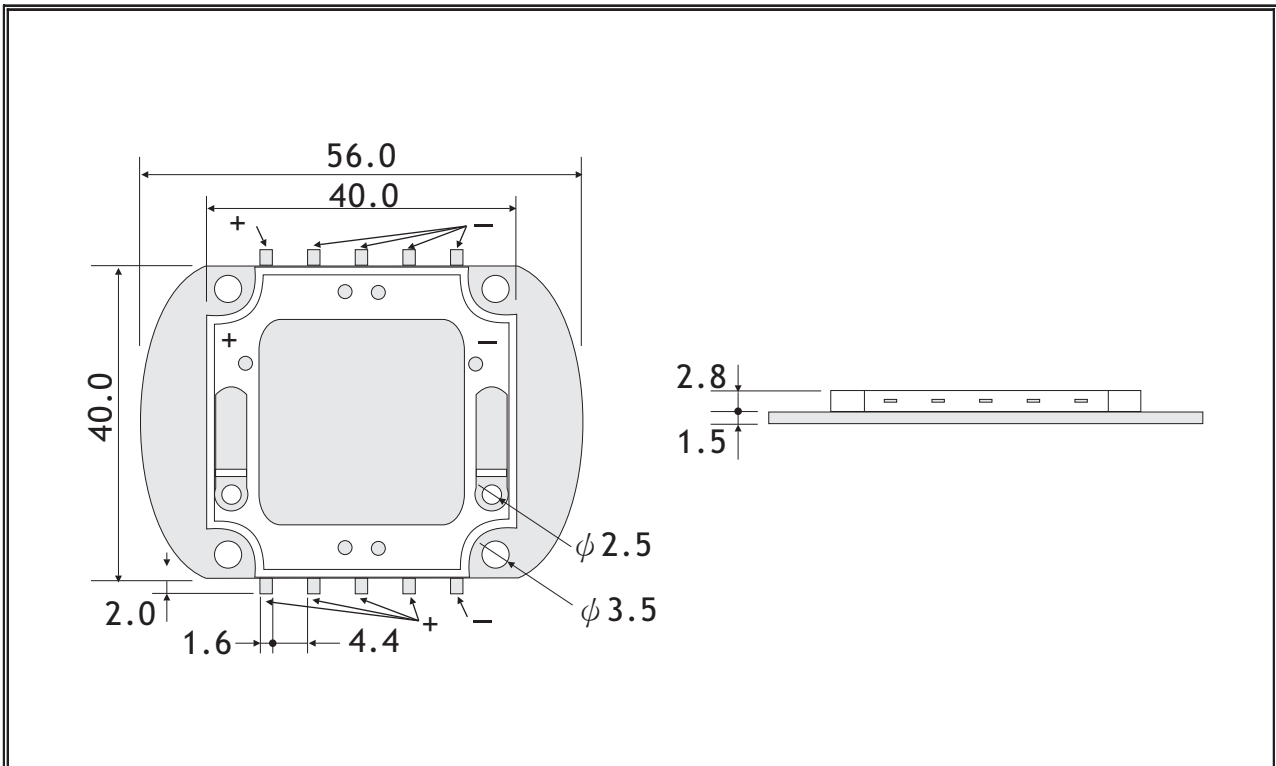

NOTE:

- 1.All dimensions are in millimeter.
- 2.Lead spacing is measured where the lead emerge from the package.
- 3.protruded resin under flange is 1.5mm max.
- 4.specifications are subject to change without notice.
- 5.Tolerance is 0.3mm unless otherwise noted.
- 6.Driving LED without heat sinking device is forbidden.
- 7.It is strongly recommended that the temperature of lead be not higher than 55°C.
- 8.Proper current derating must be observed to maintain junction temperature below the maximum.
- 9.LEDs are not designed to be driven in reserve bias.
10. Warps the degree 0.5mm.



HUEY JANN ELECTRONICS INDUSTRY CO., LTD.

No.27 Line 466 Sec.2,Cannng-nan Rd. Wu-chi Town Taichung Shien, Taiwan, R.O.C.

TEL:+886-4-26393976 FAX:+886-4-26393125

DEVICES

Item	Lens Color	Dice Source	Color Temperature Typ (°K)
HPR40E-19K100BWHA	Yellow Diffusion	GaN/GaN	8000
HPR40E-19K100WHA			6000
HPR40E-19K100NWHA			4000
HPR40E-19K100NWHA/CRI 90			
HPR40E-19K100YWHA			3300
HPR40E-19K100YWHA/CRI 90			



HUEY JANN ELECTRONICS INDUSTRY CO., LTD.

No.27 Line 466 Sec.2,Canng-nan Rd. Wu-chi Town Taichung Shien, Taiwan, R.O.C.

TEL:+886-4-26393976 FAX:+886-4-26393125

ABSOLUTE MAXIMUM RATINGS

TA=25°C

PARAMETER	SYMBOL	MAX. RATING	UNIT
Continuous Forward Current	IF	2.8	A
Peak Forward Current *1	IFM	3	A
Electrostatic Discharge (HBM)	ESD	4000	V
LED Junction Temperature	Tj	135	°C
Operating Temperature	Topr	-40 ~ +110	°C
Storage Temperature	Tstg	-40 ~ +120	°C
Manual Soldering Temperature 260 °C for 5 seconds max. *2			

*1.Duty Ratio=0.1%,Pulse Width=10us.

*2.Iron soldering high temperature will not cause damage to the dice. But be aware of the high temperature will not only make the epoxy soften but also cause the lead moving and the gold wire broken and even open. So before returning to the normal temperatures PLEASE AVOID any serious pressure on the top of epoxy and lead.

*3. We suggest using PWM (Pulse Width Modulation) for driving.

*4. It is recommended to use series as there are several 3pcs. If there are more than 5pcs, please use product with higher power.



HUEY JANN ELECTRONICS INDUSTRY CO., LTD.

No.27 Line 466 Sec.2,Cannng-nan Rd. Wu-chi Town Taichung Shien, Taiwan, R.O.C.

TEL:+886-4-26393976 FAX:+886-4-26393125

ELECTRIC-OPTICAL CHARACTERISTICS

TA=25°C

PARAMETER	SYMBOL	TEST CONDITION	MIN	TYP	MAX	UNIT
View Angle of Half Power	2θ1/2	IF=2800mA		120		deg
Forward Voltage	VF			32	34	V
Thermal Resistance Junction To Case	$R\theta_{J-C}$			0.5		°C/W
Temperature Coefficient Of Forward Voltage	$\Delta V_F/\Delta T$			-2		mV/°C

ELECTRIC-OPTICAL CHARACTERISTICS TO BE INDEPENDENT

IF=2800mA TA=25°C

Item	CCT (°K)	CRI (Ra)	Brightness (lm)
	Typical		
HPR40E-19K100BWHA	8000	75	8800
HPR40E-19K100WHA	6000		
HPR40E-19K100NWHA	4000	72	8450
HPR40E-19K100NWHA/CRI 90		90	6950
HPR40E-19K100YWHA	3300	70	7800
HPR40E-19K100YWHA/CRI 90		90	6400



HUEY JANN ELECTRONICS INDUSTRY CO., LTD.

No.27 Line 466 Sec.2,Cannng-nan Rd. Wu-chi Town Taichung Shien, Taiwan, R.O.C.

TEL:+886-4-26393976 FAX:+886-4-26393125

RELIABILITY TEST

➤ Endurance Test

Test Item	Reference Standard	Test Conditions	Result
Operation Life	MIL-STD-750:1026 MIL-STD-883:1005 JIS-C-7021 :B-1	Connect with a power if=2800mA Ta=Under room temperature Test Time=1,000hrs	0/22
High Temperature High Humidity Storage	MIL-STD-202:103B JIS-C-7021 :B-11	Ta=+85°C 5°C RH=80% ~ 85% Test Time=1,000hrs	0/22
High Temperature Storage	MIL-STD-883:1008 JIS-C-7021 :B-10	High Ta=+120°C 5°C Test Time=1,000hrs	0/22
Low Temperature Storage	JIS-C-7021 :B-12	Low Ta=-40°C 5°C Test Time=1,000hrs	0/22

*Failure Criteria:

1. VF arise \geq 10%
2. IV decline \geq 30%
3. A failure is an LED that is open or shorted



HUEY JANN ELECTRONICS INDUSTRY CO., LTD.

No.27 Line 466 Sec.2,Cannng-nan Rd. Wu-chi Town Taichung Shien, Taiwan, R.O.C.

TEL:+886-4-26393976 FAX:+886-4-26393125

RELIABILITY TEST

➤ Environmental Test

Test Item	Reference Standard	Test Conditions	Result
Temperature Cycling	MIL-STD-202:107D MIL-STD-750:1051 MIL-STD-883:1010 JIS-C-7021 :A-4	-40°C ~ +25°C ~ +85°C ~ +25°C 60min 20min 60min 20min Test Time=200cycle	0/22
Thermal Shock	MIL-STD-202:107D MIL-STD-750:1051 MIL-STD-883:1010	-40°C 5°C ~ +110°C 5°C 20min 20min Test Time=200cycle	0/22

*Failure Criteria:

1. VF arise $\geq 10\%$
2. IV decline $\geq 30\%$
3. A failure is an LED that is open or shorted



HUEY JANN ELECTRONICS INDUSTRY CO., LTD.

No.27 Line 466 Sec.2,Canng-nan Rd. Wu-chi Town Taichung Shien, Taiwan, R.O.C.

TEL:+886-4-26393976 FAX:+886-4-26393125

TYPICAL ELECTRICAL OPTICAL CHARACTERISTICS CURVES

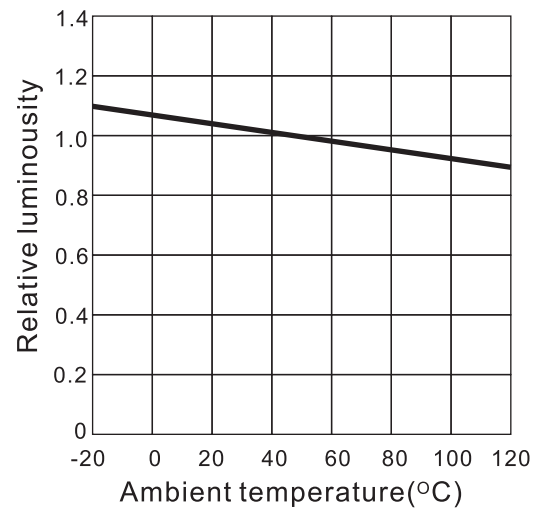
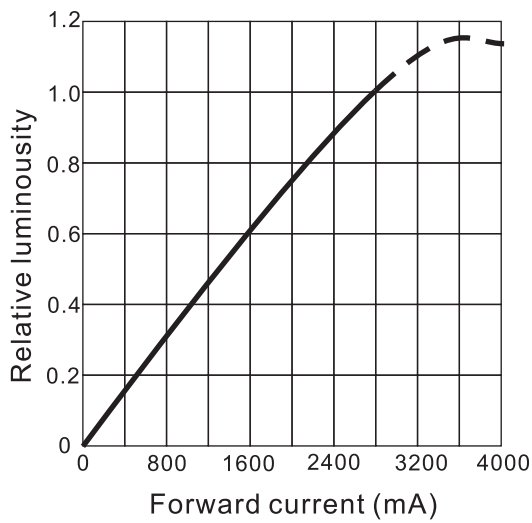
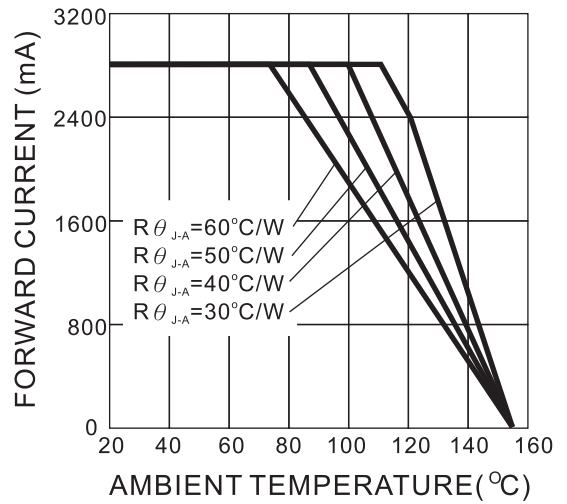
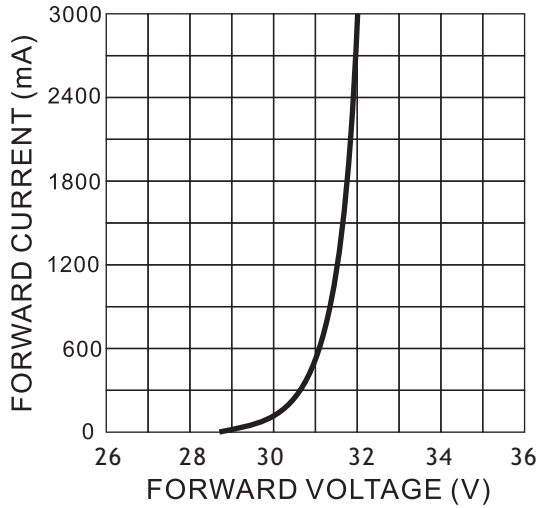

HUEY JANN ELECTRONICS INDUSTRY CO., LTD.

No.27 Line 466 Sec.2,Cannng-nan Rd. Wu-chi Town Taichung Shien, Taiwan, R.O.C.

TEL:+886-4-26393976 FAX:+886-4-26393125

TYPICAL ELECTRICAL OPTICAL CHARACTERISTICS CURVES

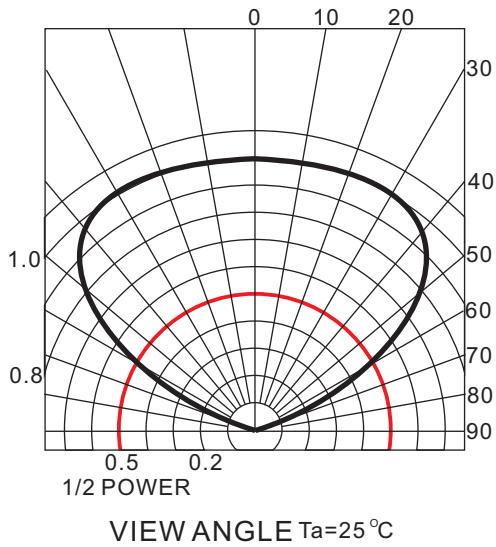
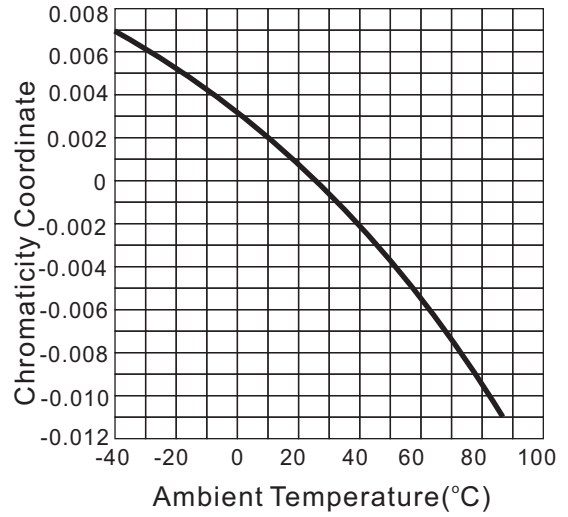
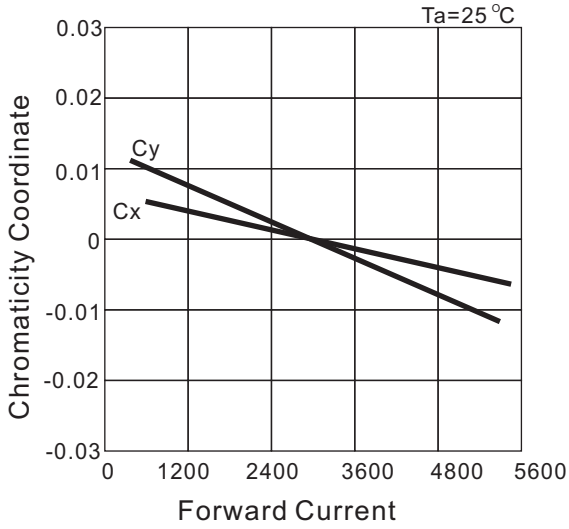

HUEY JANN ELECTRONICS INDUSTRY CO., LTD.

No.27 Line 466 Sec.2,Canng-nan Rd. Wu-chi Town Taichung Shien, Taiwan, R.O.C.

TEL:+886-4-26393976 FAX:+886-4-26393125

TYPICAL ELECTRICAL OPTICAL CHARACTERISTICS CURVES

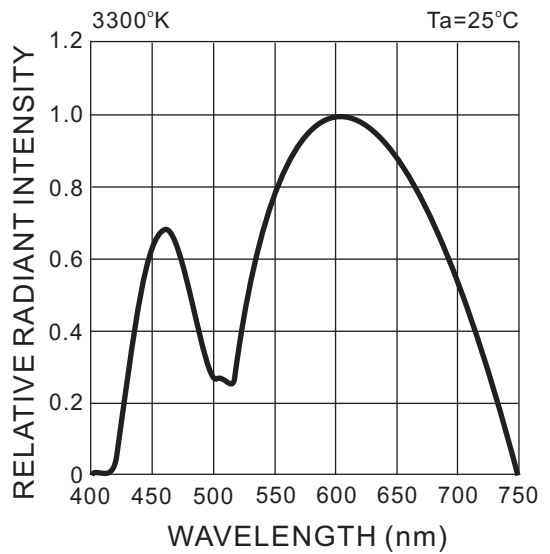
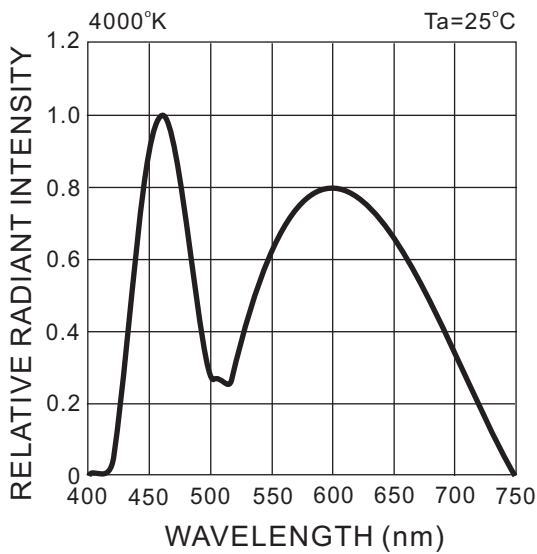
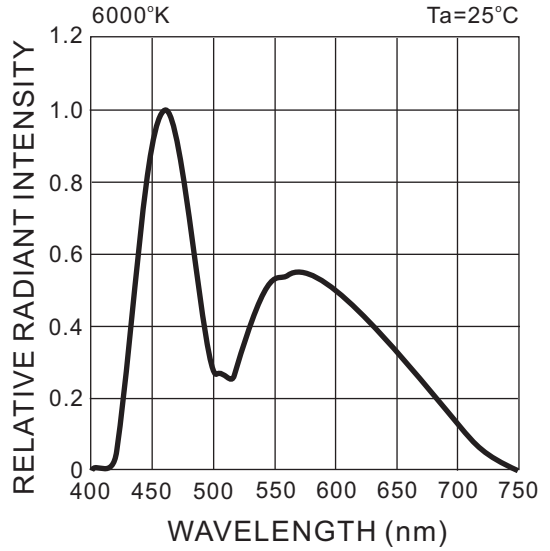
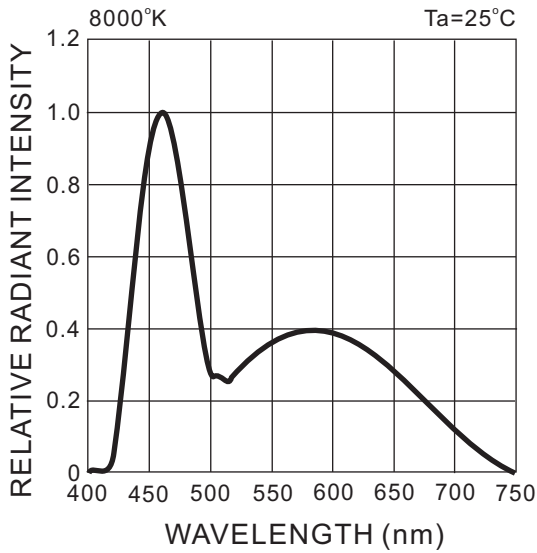

HUEY JANN ELECTRONICS INDUSTRY CO., LTD.

No.27 Line 466 Sec.2,Cannng-nan Rd. Wu-chi Town Taichung Shien, Taiwan, R.O.C.

TEL:+886-4-26393976 FAX:+886-4-26393125

Cool White Color Bin Selection

CCT(°K)	Chromaticity Coordinates					
TYP						
8000	x	0.274	0.303	0.311	0.290	
	y	0.301	0.333	0.293	0.270	
Tolerance		$x \pm 0.02$			$y \pm 0.02$	

Cool White CIE Light Color Chart

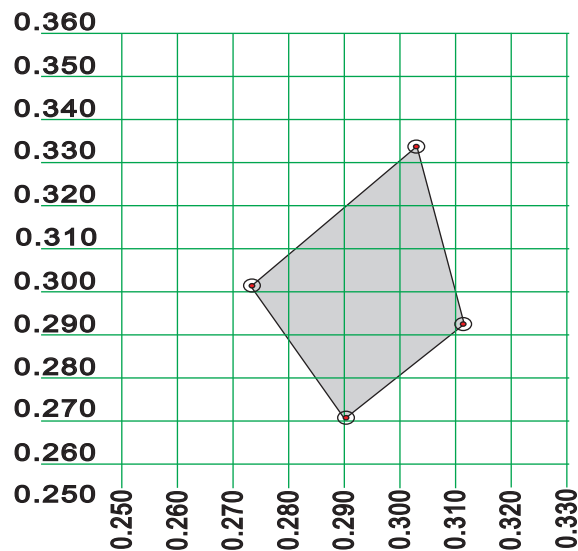

HUEY JANN ELECTRONICS INDUSTRY CO., LTD.

No.27 Line 466 Sec.2,Canng-nan Rd. Wu-chi Town Taichung Shien, Taiwan, R.O.C.

TEL:+886-4-26393976 FAX:+886-4-26393125

Pure White Color Bin Selection

CCT(°K)		Chromaticity Coordinates			
TYP					
6000	x	0.301	0.329	0.329	0.311
	y	0.342	0.369	0.310	0.293
Tolerance		$x \pm 0.02$		$y \pm 0.02$	

Pure White CIE Light Color Chart

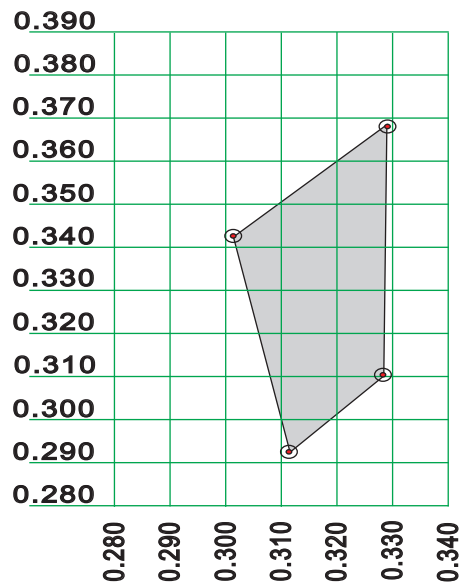

HUEY JANN ELECTRONICS INDUSTRY CO., LTD.

No.27 Line 466 Sec.2,Canng-nan Rd. Wu-chi Town Taichung Shien, Taiwan, R.O.C.

TEL:+886-4-26393976 FAX:+886-4-26393125

☰ Nature White Color Bin Selection

CCT(°K)	Chromaticity Coordinates				
TYP					
4000	x	0.367	0.420	0.396	0.357
	y	0.400	0.432	0.367	0.342
Tolerance		$x \pm 0.02$		$y \pm 0.02$	

☰ Nature White CIE Light Color Chart

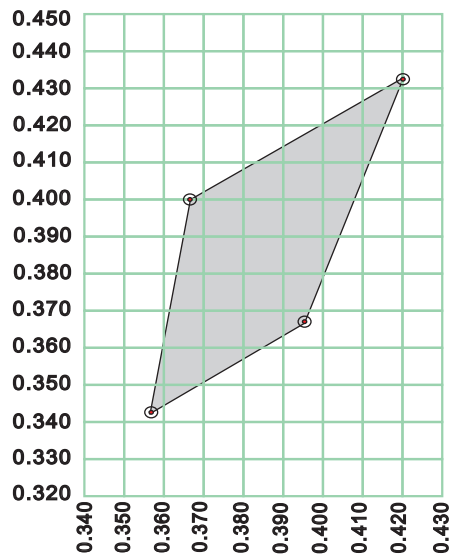

HUEY JANN ELECTRONICS INDUSTRY CO., LTD.

No.27 Line 466 Sec.2,Canng-nan Rd. Wu-chi Town Taichung Shien, Taiwan, R.O.C.

TEL:+886-4-26393976 FAX:+886-4-26393125

Warm White Color Bin Selection

CCT(K)	Chromaticity Coordinates						
TYP							
3300	x	0.402	0.454	0.429	0.416	0.410	0.383
	y	0.423	0.446	0.394	0.389	0.374	0.360
Tolerance		x ± 0.02			y ± 0.02		

Warm White CIE Light Color Chart

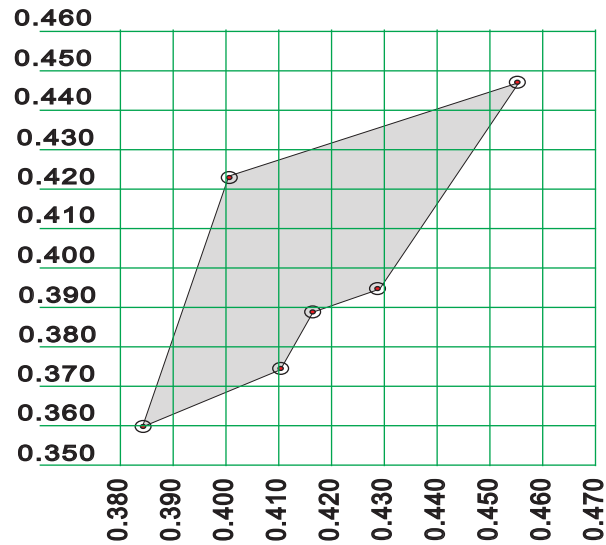

HUEY JANN ELECTRONICS INDUSTRY CO., LTD.

No.27 Line 466 Sec.2,Canng-nan Rd. Wu-chi Town Taichung Shien, Taiwan, R.O.C.

TEL:+886-4-26393976 FAX:+886-4-26393125

100W Thermal conductive glue spreading instruction

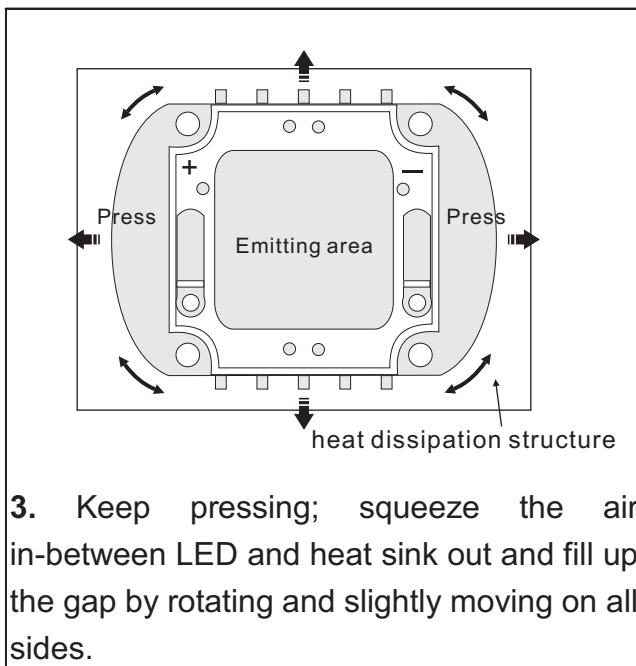
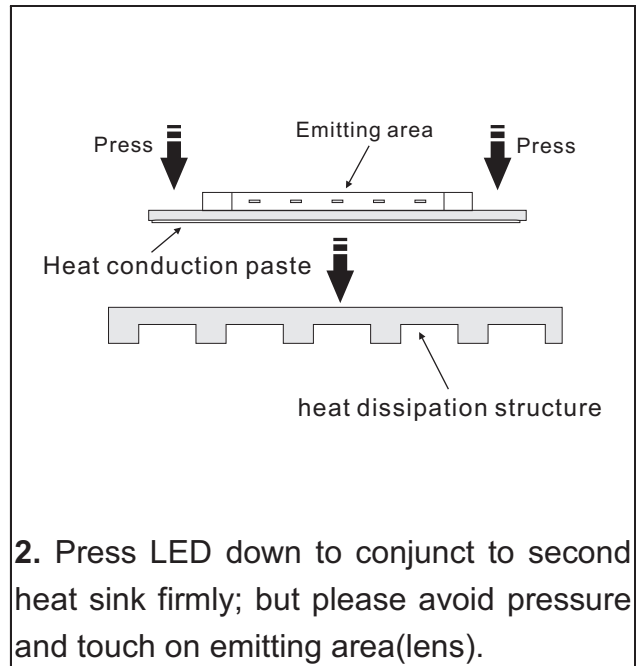
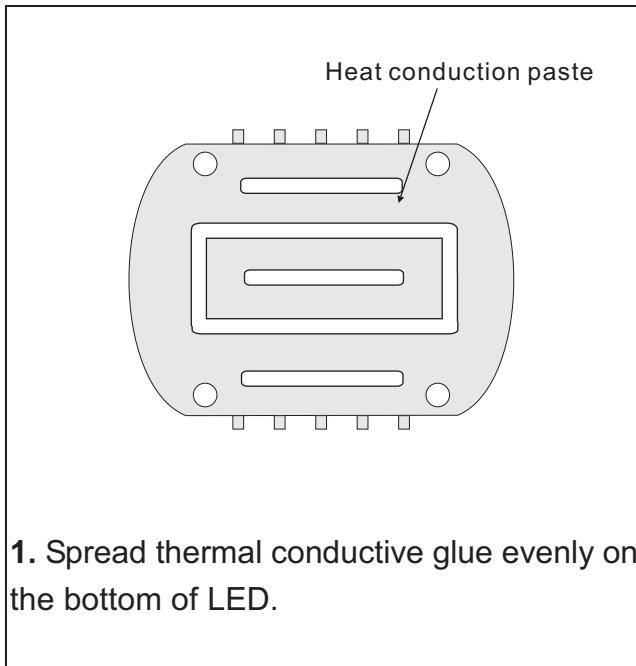

HUEY JANN ELECTRONICS INDUSTRY CO., LTD.

No.27 Line 466 Sec.2,Cannng-nan Rd. Wu-chi Town Taichung Shien, Taiwan, R.O.C.

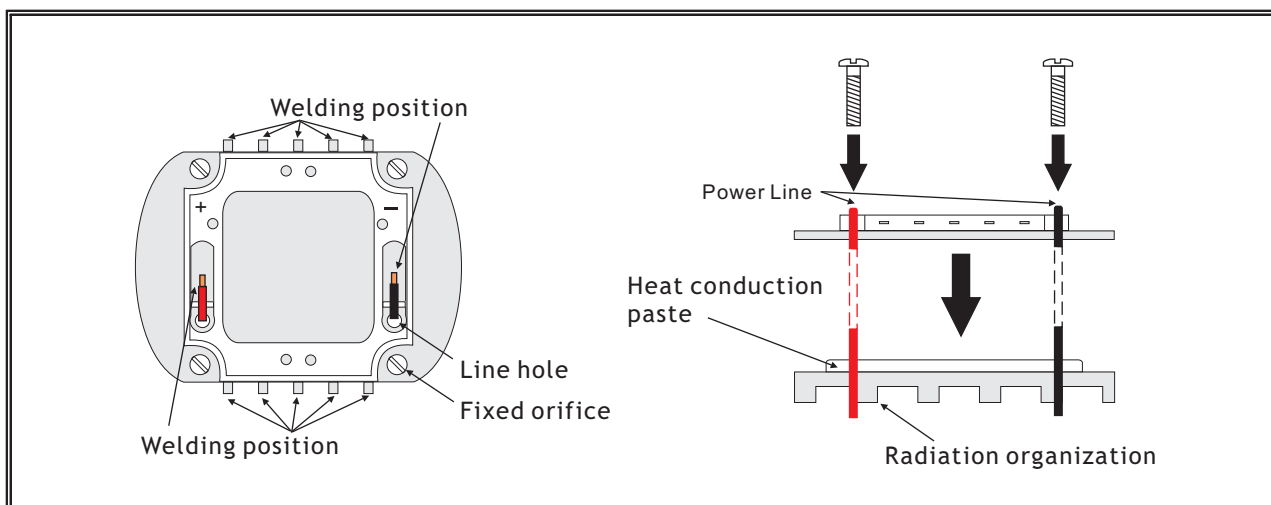

TEL:+886-4-26393976 FAX:+886-4-26393125

POSITION EXPLANATION:



Conclusion

Huey Jann provide simple comparison table for High Power LED, you could find your request heat dissipation area from the following table.

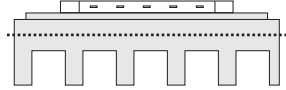
	 Free Convection Horizontal Flat Heat Dissipation-Set-up (Area Require mm ²)	 Free Convection Vertical Flat Heat Dissipation-Set-up (Area Require mm ²)	 Free Convection Finned Heat Dissipation-Set-up (Area Require mm ²)
100W	107,000	79,500	371,000

*TAB in this table is according to highest operating temperature 65°C.

*Different materials of second heat dissipation device, the surface area of heat sink will be different. Thus, this document is for reference only.



HUEY JANN ELECTRONICS INDUSTRY CO., LTD.

No.27 Line 466 Sec.2, Cannng-nan Rd. Wu-chi Town Taichung Shien, Taiwan, R.O.C.

TEL:+886-4-26393976 FAX:+886-4-26393125

PRODUCT APPLICATION

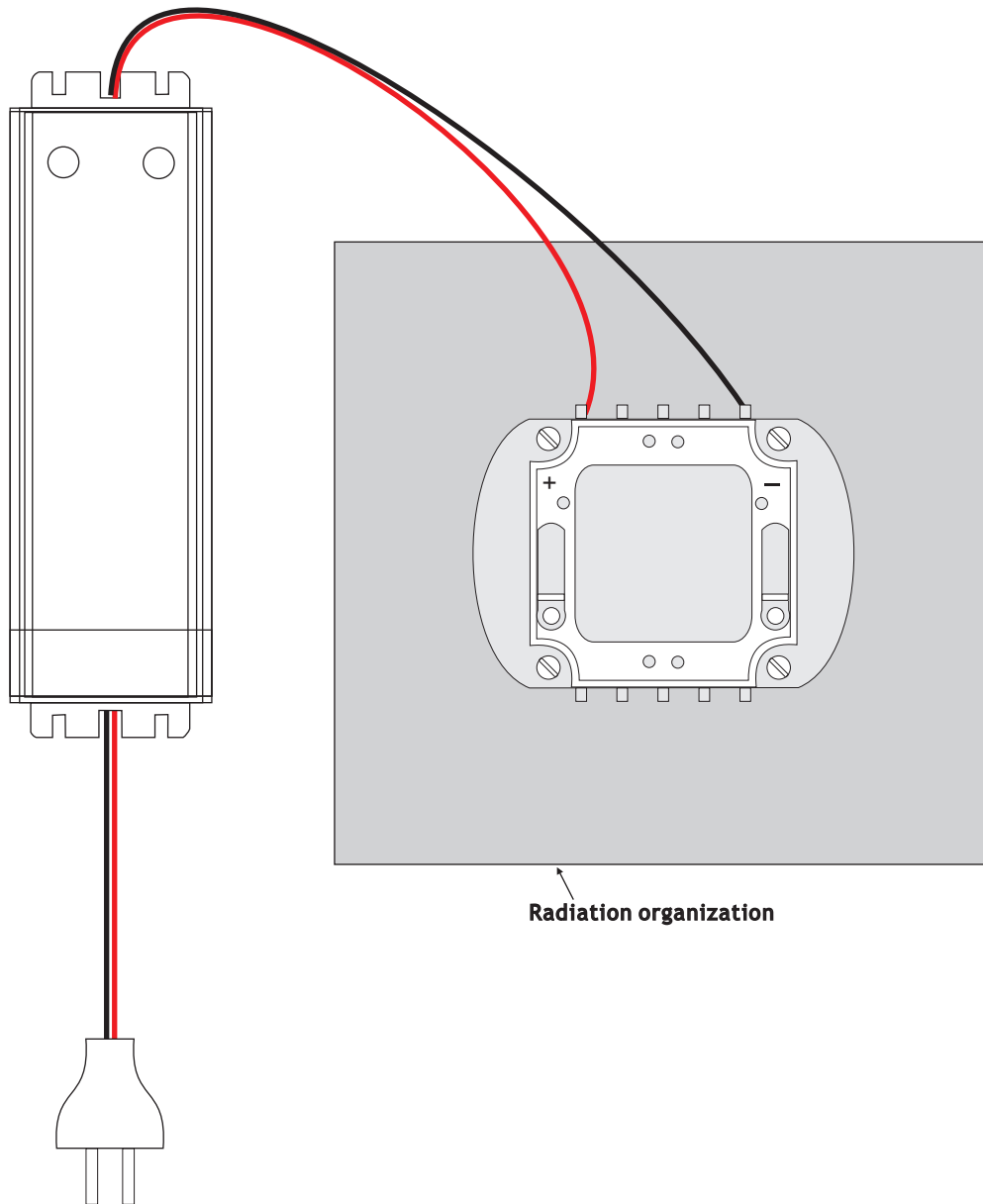

HUEY JANN ELECTRONICS INDUSTRY CO., LTD.

No.27 Line 466 Sec.2,Cannng-nan Rd. Wu-chi Town Taichung Shien, Taiwan, R.O.C.

TEL:+886-4-26393976 FAX:+886-4-26393125

100W Operating Instructions

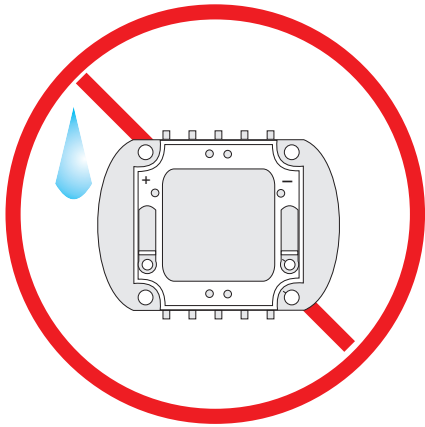

1. It is important to keep away the product from water, in order to avoid the product's electronic characteristics from being harmful.

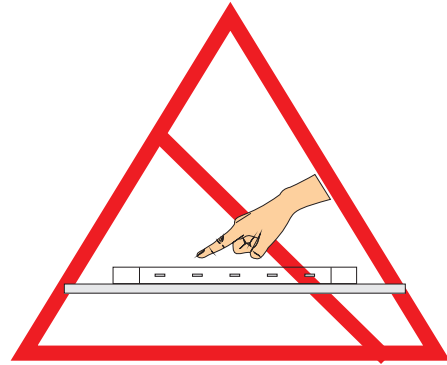

2. When making use of products, it is necessary to use anti-ESD devices to prevent destructive electronic characteristics.

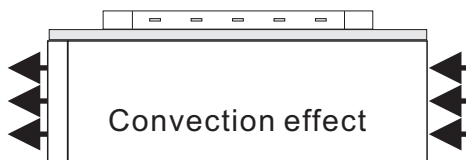

3. It should be noticed whether there is convection in the design of the device. Convection must exist.

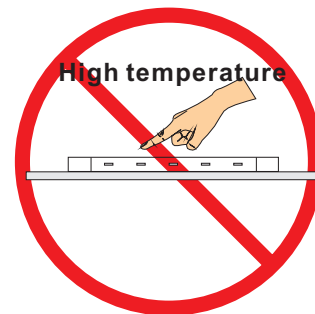

Above 150°C

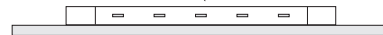

4. There is 150°C directly from the front of the 100W emitting diode. It is untouchable to prevent burning.



HUEY JANN ELECTRONICS INDUSTRY CO., LTD.

No.27 Line 466 Sec.2, Cangg-nan Rd. Wu-chi Town Taichung Shien, Taiwan, R.O.C.

TEL:+886-4-26393976 FAX:+886-4-26393125

100W Operating Instructions

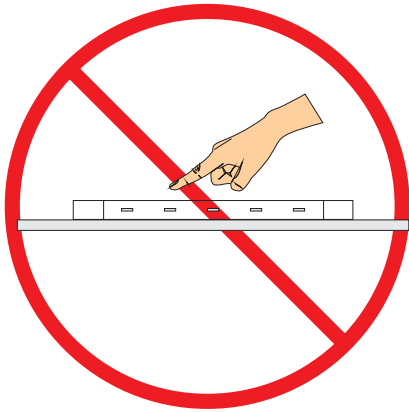

5. The material in the central top of 100W LED is soft. Therefore, it is un-squeezable and untouchable.



Keep Insulation

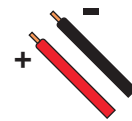

Power Supply

6. In the bottom of heat sink cannot be touched with neither positive nor negative pole. (Heat sink has to be insulation.)

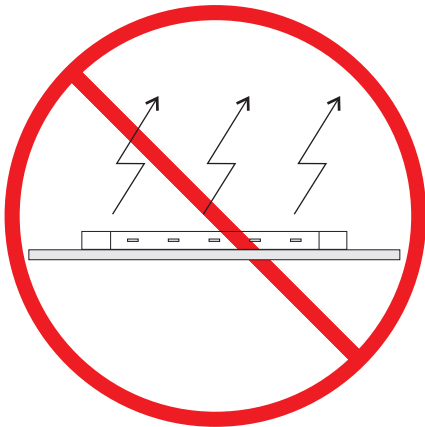

7. The product should not be light up directly without heat dissipation device.



HUEY JANN ELECTRONICS INDUSTRY CO., LTD.

No.27 Line 466 Sec.2,Canng-nan Rd. Wu-chi Town Taichung Shien, Taiwan, R.O.C.

TEL:+886-4-26393976 FAX:+886-4-26393125

TAB Temperature - Life Characteristics Curves

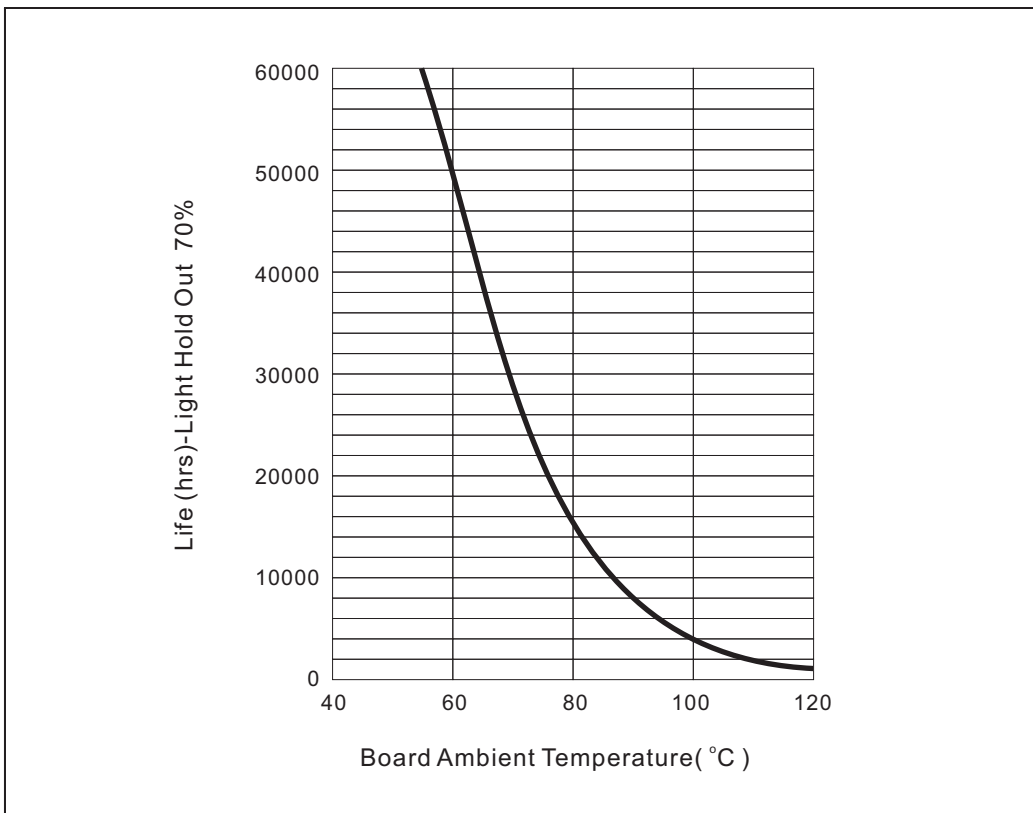
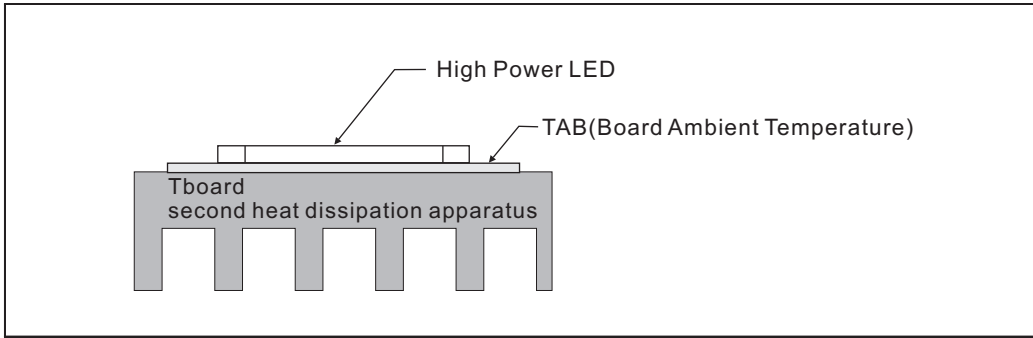

*Board Ambient Temperature Tolerance 5°C.

*TAB in this table is according to highest operating temperature 65°C.

*The TAB is the stable testing value for the product lighted 100% after one hour.

*Different materials of second heat dissipation device, the surface area of heat sink will be different. Thus, this document is for reference only.



HUEY JANN ELECTRONICS INDUSTRY CO., LTD.

No.27 Line 466 Sec.2,Cann-g-nan Rd. Wu-chi Town Taichung Shien, Taiwan, R.O.C.

TEL:+886-4-26393976 FAX:+886-4-26393125

Remarks:

1. Brightness values are measured during a current pulse of typical 25 ms, the brightness tolerance is +/-15%.
2. Chromaticity coordinates are measured during a current pulse of typical 200 ms, the chromaticity tolerance is +/-0.015.
3. Forward voltage are measured during a current pulse of typical 5 ms, the VF tolerance is +/-0.15V.
4. Dimensions are specified as follows: mm.
5. Related technical parameters of LED are average value resulted from statistic. The actual parameters of LED could be slightly different from average and characteristic curve.
6. The average value of LED will be changed by technical improvement and elevation, and subject to change without prior notice.
7. Hi-Power LED can not be operated without second heat dissipating structure.
8. Poor or damaged second heat dissipating structure could lead to defective electrical characteristic of High Power LED, CCT escalation, brightness drop, lifetime shortening or burn out. Following instructions of Huey Jann Hi-Power LED series document can avoid LED burn out and electrical defectiveness due to improper usage, and maintain normal performance of the products.
9. Suggestion: Fix LED with screw on second heat sink, in order to attach LED firmly with it.
10. After drilling holes on second heat sink. Burr will occur easily. In order to avoid non-firmly connection between LED and second heat sink and affect LED life span, burr need to be trimmed prior to use.
11. Before fixing LED on second heat sink with screw, except for trimming burr, Thermal conductive glue or pad needs to be spread evenly on the bottom of LED. Please refer to "instruction for thermal conductive glue usage" in our datasheet for spread method.
12. For parts 50W Hi-Power LED or higher, since brightness is highly concentrated, due to conversion of light to heat, after continuously lighting up for 1000hrs, CCT will slightly increase and brightness will naturally decay.



HUEY JANN ELECTRONICS INDUSTRY CO., LTD.

No.27 Line 466 Sec.2,Cannng-nan Rd. Wu-chi Town Taichung Shien, Taiwan, R.O.C.

TEL:+886-4-26393976 FAX:+886-4-26393125