

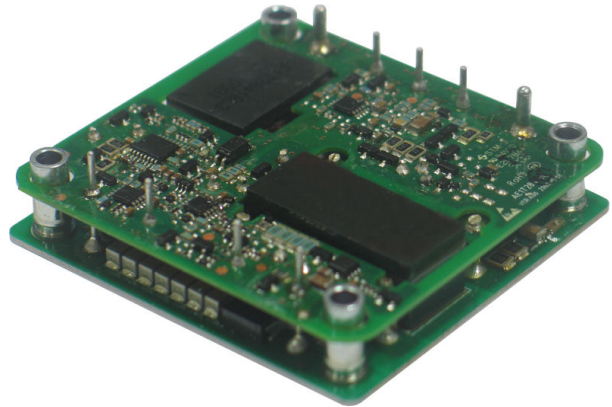

48Vdc Input, 28Vdc@12.5A Output Half-brick DC-DC Converter AVE350B-48S28-6

Description

The AVE350B-48S28-6 converter is a new DC/DC converter with aluminum baseplate for optimum efficiency and power density. The converter provides up to 12.5A output current, which makes it an ideal choice for small space and high power applications. The converter uses an industry standard half brick 61.0mm×57.9mm×12.7mm (2.4"×2.28"×0.5") and standard pin configuration. The converter provides CNT, Trim and remote sense functions.



Operational Features

- Delivering up to 12.5A output current
- Ultra-high efficiency 93.5% type at full load and 93.2% type at half load
- Wide input range: 36V ~ 75V
- Excellent thermal performance
- No minimum load requirement
- RoHS compliant (R5 or R6 optional)

Control Features

- Remote control function (negative or positive logic optional)
- Remote output sense
- Trim function: 60% ~ 118%

Protection Features

- Input under voltage lockout
- Output over current protection
- Output over voltage protection
- Over temperature protection

Mechanical Features

- Industry standard half-brick pin-out outline
- With baseplate
- Pin length: 3.8mm

Safety & EMC

- Meets safety standards UL 60950-1, CSA-C22.2 NO. 60950-1, IEC/EN 60950-1 and GB4943
- Approved by UL and TUV
- Meets 2006/95/EEC and 93/68/EEC directives which facilitates CE marking in user's end product
- Meets conducted emission's requirements of EN55022 Class B with external filter

Electrical Characteristics

Full operating ambient temperature range is -40°C to +85°C.

Specifications are subject to change without notice.

Parameter		Min.	Typ.	Max.	Unit	Notes & Conditions
Absolute max. ratings						
Input voltage	Non-operating			100	V	100ms
	Operating			80	V	Continuous
Operating temperature		-40		85	°C	Refer to <i>Thermal Considerations</i>
Storage temperature		-55		125	°C	
Output power				350	W	Refer to <i>Thermal Considerations</i>
Voltage at remote ON/OFF pin		-0.3		15	V	
Input characteristics						
Operating input voltage range		36	48	75	V	
Input under-voltage lockout	Turn-on voltage threshold	33	35	36	V	
	Turn-off voltage threshold	31	33	35	V	
	Lockout voltage hysteresis	1	2	3	V	
Max. input current			10.5	11.5	A	36V _{in} , full load
No-load input current			0.035		A	
Standby Input current			0.001		A	Remote OFF
Input reflected ripple current			35		mA _{pp}	Through 12μH inductor; Figure 15
Recommended input fuse				15	A	Fast blow external fuse recommended; Figure 10
Input filter component values (CL)			70.68		μF\μH	Internal values
Recommended external input capacitance			220		μF	Low ESR capacitor recommended; Figure 10
Output characteristics						
Output voltage set point (standard option)		27.72	28	28.28	V	48V _{in} , half load, Ta=25°C
Output voltage line regulation			0.05	1	%	
			14	140	mV	Rating output, V _{in} =36~75V
Output voltage load regulation			0.1	1	%	
			28	280	mV	Rating input, I _o =0~12.5A

Parameter		Min.	Typ.	Max.	Unit	Notes & Conditions
Output voltage temperature regulation			0.01	0.02	%/°C	
Total output voltage range		27.16	28	28.84	V	Over sample, line, load, temperature & life
Output voltage ripple and noise			120	200	mVpp	Figure 2; External capacitor of 750µF at 25°C. Additional capacitor is needed at low temperature 20MHz bandwidth; Figure 15
Operating output current range		0		12.5	A	
Output DC current-limit inception		13.125		17.5	A	Hiccup: auto-restart when over-current condition is removed see Figure 9
Output capacitance ^[1]		680	750	4000	µF	High frequency and low ESR are recommended
Dynamic characteristics						
Dynamic response	50% ~ 75% ~ 50% $I_{o,max}$, 0.1A/µs		210	840	mV	Figure 4 Test condition: 25°C, nominal input voltage, 25% $I_{o,nom}$ step from 50% $I_{o,nom}$, 0.1A/µs, see Figure 10
	Settling time		0	500	µs	
Turn-on transient	Rise time		16	100	ms	Full load, Figure 5
	Turn-on delay time		17	50	ms	Whole range
	Output voltage overshoot		0	-	% V_o	$I_o=I_{o,max}$; $T_a=25^\circ\text{C}$
Efficiency						
100% load			93.5		%	$T_a=25^\circ\text{C}$, $T_c^{[2]}<40^\circ\text{C}$, $V_{in}=48\text{V}$, $V_o=28\text{V}$, see Figure 1
50% load			93.2		%	$T_a=25^\circ\text{C}$, $T_c<40^\circ\text{C}$, $V_{in}=48\text{V}$, $V_o=28\text{V}$, see Figure 1
<p>Note1: If electrolytic capacitor is used, double capacitance is necessary when $T_a<0^\circ\text{C}$ as the value of electrolytic capacitor will decrease under low temperature.</p> <p>Note2: T_c is the temperature of the baseplate ,the test point refers to Figure18</p>						

Electrical Characteristics (Continued)

Parameter	Min.	Typ.	Max.	Unit	Notes & Conditions	
Isolation characteristics						
Isolation voltage (conditions: 1mA for 60s, slew rate of 1500V/10s)	1500			V	Functional insulation, pollution degree 2, input to output	
	1500			V	Functional insulation, pollution degree 2, input to baseplate	
	500			V	Functional insulation, pollution degree 2, output to baseplate	
Feature characteristics						
Switching frequency		285	0	kHz		
Remote ON/OFF control (positive logic)	Off-state voltage	-0.3		0.8	V	See Figure 11
	On-state voltage	2.4		15	V	
Remote ON/OFF control (negative logic)	Off-state voltage	2.4		15	V	
	On-State Voltage	-0.3		0.8	V	
Output voltage trim range	60		118	%V _{o,nom}	See <i>Trim Characteristics</i> of <i>Application Note</i>	
Output voltage remote sense range			0.5	V		
Output over-voltage protection	115		140	%V _{o,nom}	Latch: remain latched after OVP shutdown until power on or remote ON	
Over-temperature shutdown on baseplate	105	115	125	°C	Auto recovery; Test points: see Figure 18	
Over-temperature hysteresis	5			°C		
Reliability characteristics						
Calculated MTBF (telcordia)		2		10 ⁶ h	25°C T _a . Normal Input/output rated. Telcordia SR-332-2006	

Electromagnetic compatibility requirements

Test Item	Regulations	Criteria	Notes & Conditions
Conducted Emission	EN 55022 DC input port, Class B Limits	/	See EMC test conditions, see Figure 16
Immunity to Electrostatic Discharge	IEC/EN61000-4-2 Enclosure Port, Level 3	B	
Immunity to Electrical Fast Transient	IEC/EN61000-4-4 DC input port, Level 3	B	
Immunity to Surges	IEC/EN61000-4-5 DC input port Line to Ground(earth): 500V Line to Line: 500V	B	
Immunity to Continuous Conducted Interference	IEC/EN61000-4-6 DC input port, Level 2	A	
Immunity To Voltage Dips and short interruptions and voltage variations	EN 61000-4-29 DC input port	B	

Criterion A: Normal performance during and after test.

Criterion B: For EFT and surges, low-voltage protection or reset is not allowed. Temporary output voltage fluctuation ceases after disturbances ceases, and from which the EUT recovers its normal performance automatically. For Dips and ESD, output voltage fluctuation or reset is allowed during the test, but recovers to its normal performance automatically after the disturbance ceases.

Criterion C: Temporary loss of output, the correction of which requires operator intervention.

Criterion D: Loss of output which is not recoverable, owing to damage to hardware.

Qualification Testing

Parameter	Unit (pcs)	Test condition
Halt test	4 ~ 5	$T_{a,min}-10^{\circ}C$ to $T_{a,max}+10^{\circ}C$, $5^{\circ}C$ step, V_{in} = min to max, 0 ~ 105% load
Vibration	3	Frequency range: 5Hz ~ 20Hz, 20Hz ~ 200Hz, A.S.D: $1.0m^2/s^3$, -3db/oct, axes of vibration: X/Y/Z Time: 30min/axis
Mechanical shock	3	30g, 6ms, 3axes, 6directions, 3time/direction
Thermal shock	3	-40°C to 100°C, unit temperature 20cycles
Thermal cycling	3	-40°C to 85°C, temperature change rate: 1°C/min, cycles: 2cycles
Humidity	3	40°C, 95%RH, 48h
Solder ability	15	IPC J-STD-002C-2007

Characteristic Curves

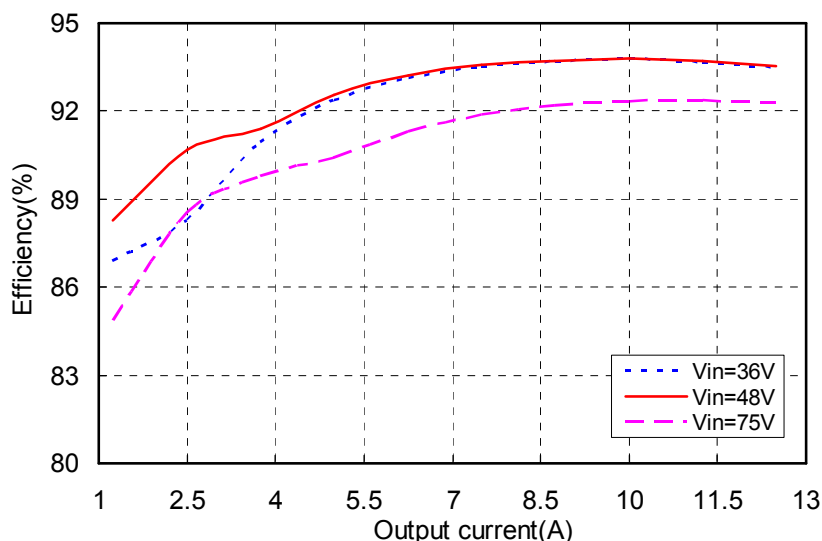

Figure 1 Efficiency vs. output current, $T_a=25^{\circ}\text{C}$, $T_c<40^{\circ}\text{C}$, $V_o=28\text{V}$

T_c : temperature test point on baseplate, see Figure 18 for test configuration

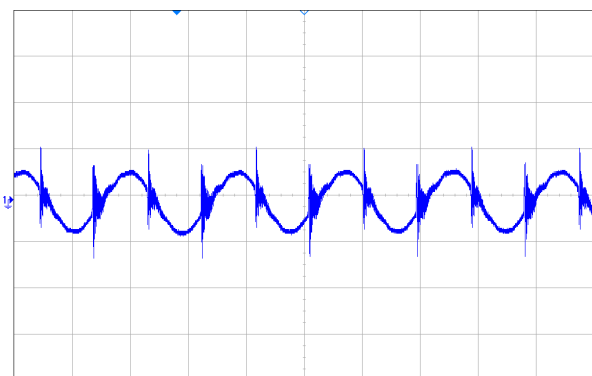

Figure 2 Output ripple & noise (2 $\mu\text{s}/\text{div}$, 50mV/div), see Figure 15 for test configuration

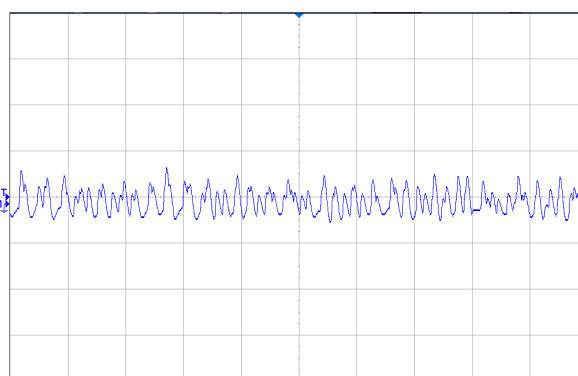

Figure 3 Input reflected ripple current (2 $\mu\text{s}/\text{div}$, 50mA/div), see Figure 15 for test configuration

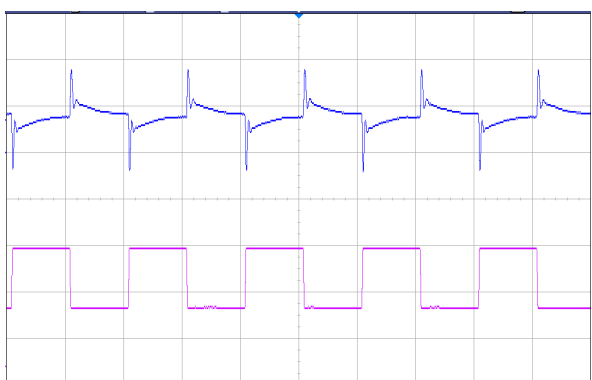

Figure 4 Dynamic response for 25% load step (25% ~ 50% ~ 25%) and 0.1A/ μs slew rate, (2ms/div), see Figure 10 for test configuration; CH1-output voltage (200mV/div); CH2-output current (2.5A/div)

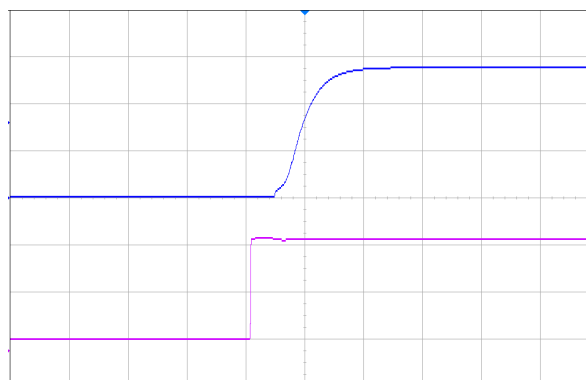

Figure 5 Output voltage startup by power on, (20ms/div), see Figure 10 for test configuration; CH1-output voltage (10V/div); CH2-input voltage (20V/div)

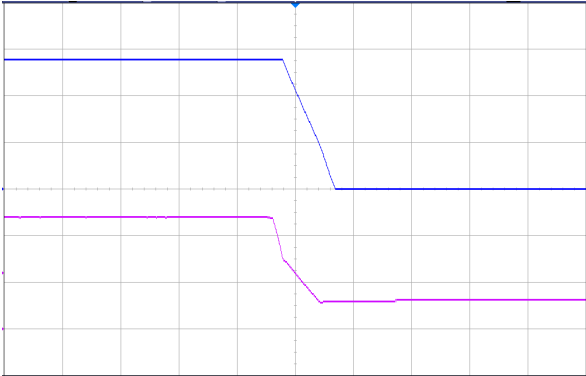

Figure 6 Output voltage shut down by power off, (2ms/div), see Figure 10 for test configuration; CH1-output voltage (10V/div); CH2-input voltage (20V/div)

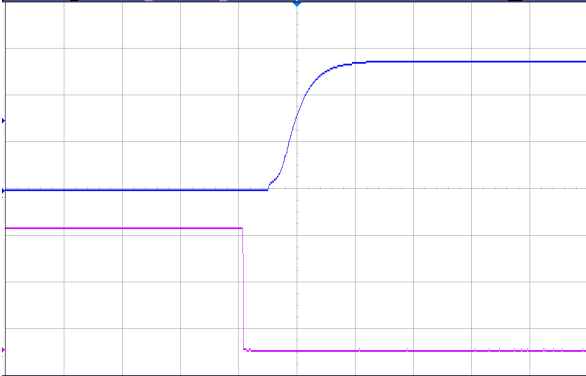

Figure 7 Output voltage startup by remote ON, (20ms/div), see Figure 10 for test configuration; CH1-output voltage (10V/div); CH2-remote ON (2V/div)

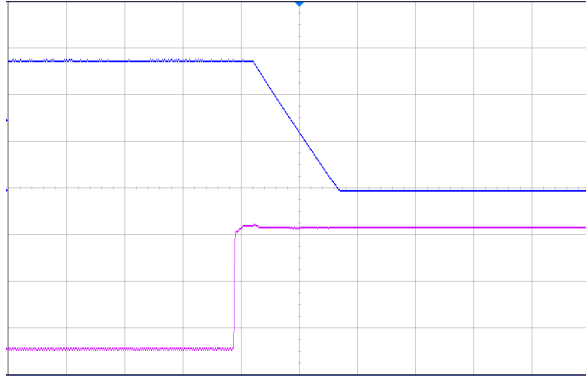

Figure 8 Output voltage shutdown by remote OFF, (1ms/div), see Figure 10 for test configuration; CH1-output voltage (10V/div); CH2-remote OFF voltage (2V/div)

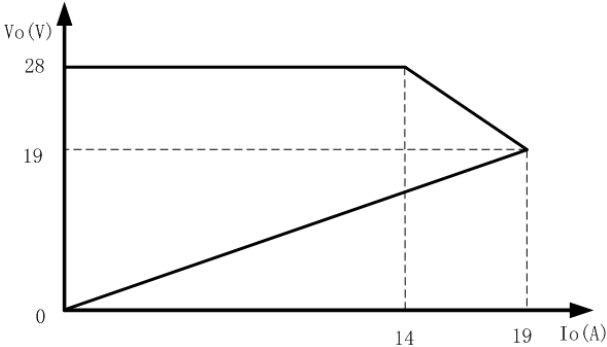

Figure 9 Over-current protection characteristic

Application Note

Typical Application

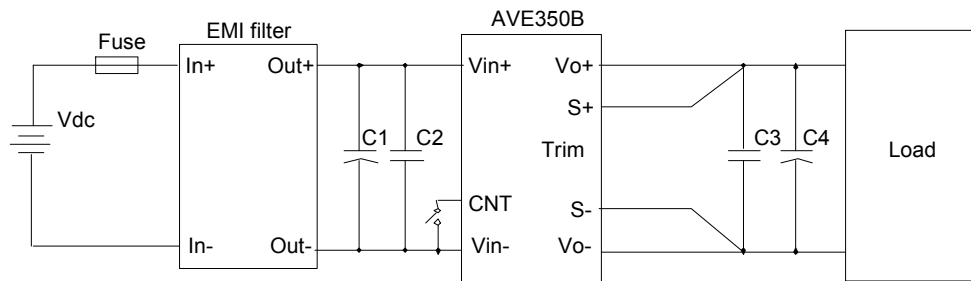

Figure 10 Typical application

C1: 220 μ F/100V electrolytic capacitor, P/N: UPM2A221MHD (Nichicon) or equivalent caps

C2, C3: 1 μ F/100V X7R ceramic capacitor, P/N: C3225X7R2A105KT0L0U (TDK) or equivalent caps

C4: 750 μ F/50V electrolytic capacitor (150 μ F*5pcs), P/N: UUD1H151MNL1GS (Nichicon) or equivalent caps

Note: If ambient temperature is below -5°C, double input & output capacitance is necessary for normal operation and performance.

Fuse: External fast blow fuse with a rating of 15A. The recommended fuse model is 324015P from LITTELFUSE.

Remote ON/OFF

Either positive or negative remote ON/OFF logic is available in AVE350B-48S28-6. The logic is CMOS and TTL compatible.

Some typical applications for CNT function refer to Figure 11.

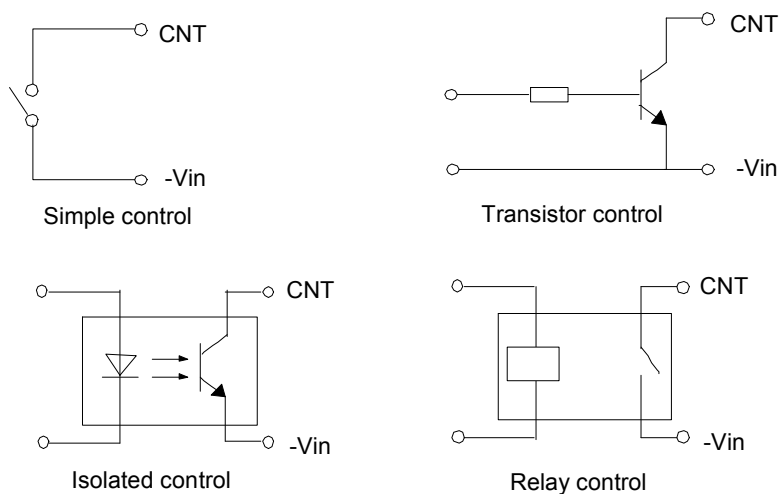

Figure 11 Remote ON/OFF internal diagram

Trim Characteristics

Connecting an external resistor between Trim pin and V_o- pin will decrease the output voltage. While connecting it between Trim and V_o+ will increase the output voltage. The following equations determine the external resistance to obtain the trimmed output voltage.

$$R_{adj_down} = \left(\frac{100\%}{\Delta\%} - 2 \right) k\Omega$$

$$R_{adj_up} = \left(\frac{V_o(100\% + \Delta\%)}{1.225 \times \Delta\%} - \frac{100\% + 2 \times \Delta\%}{\Delta\%} \right) k\Omega$$

$\Delta\%$: Output voltage rate against nominal output voltage.

V_{norm} : Nominal output voltage.

For example, to get 32.2V output, the trimming resistor is

$$R_{adj_up} = \left(\frac{32.2}{1.225 \times (32.2 - 28) / 28} - \frac{100\% + 2 \times (32.2 - 28) / 28}{(32.2 - 28) / 28} \right) k\Omega = 166.57 k\Omega$$

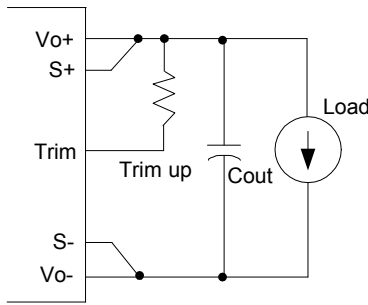

Figure 12 Trim up

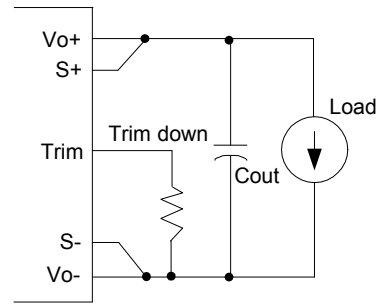

Figure 13 Trim down

The output voltage can also be trimmed by potential applied at the Trim pin.

$$V_o = (11.43 \times V_{trim} + 14)V$$

Where V_{trim} is the potential applied at the Trim pin, and V_o is the desired output voltage.

When trimming up, the output current should be decreased accordingly so as not to exceed the maximum output power and the minimum input voltage should be increased as shown in Figure14.

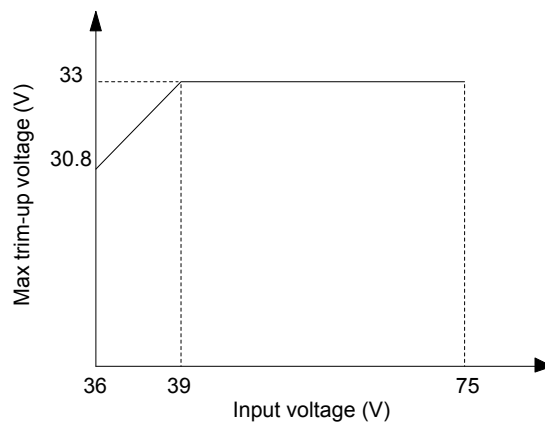

Figure 14 Max trim-up voltage vs. input voltage

Sense Characteristics

If the load is far from the unit, connect S+ and S- to the terminal of the load respectively to compensate the voltage drop on the transmission line. See Figure 10.

If the sense compensate function is not necessary, connect S+ to V_{o+} and S- to V_{o-} directly.

Input Ripple & Inrush Current And Output Ripple & Noise Test Configuration

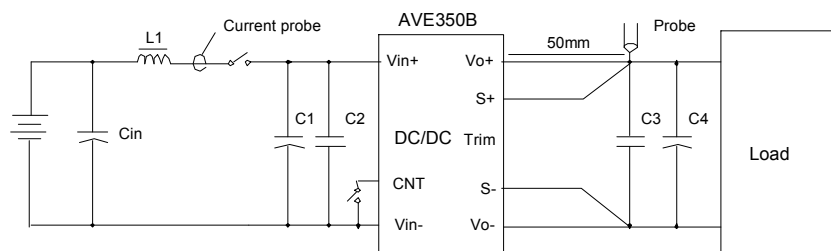

Figure 15 Input ripple & inrush current, ripple & noise test configuration

Vdc: DC power supply

L1: 12µH

Cin: 220µF/100V typical

C1 ~ C4: See Figure 10

Note: Using a coaxial cable with series 50Ω resistor and 0.68µF ceramic capacitor or a ground ring of probe to test output ripple & noise is recommended.

EMC Filter Configuration

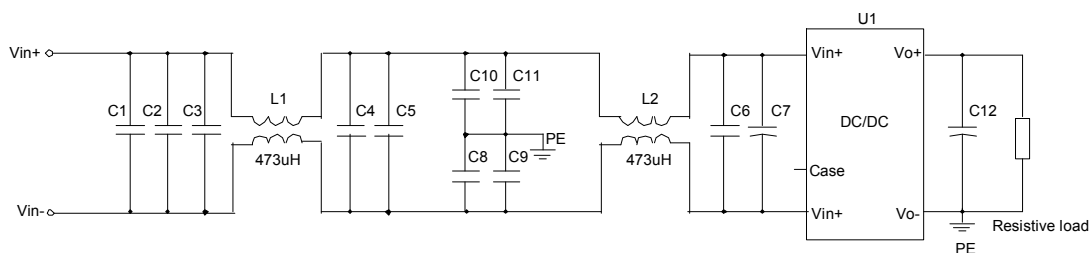

Figure 16 EMC test configuration

U1: Module to test, AVE350B-48S28-6

C1 ~ C5: 1µF/100V X7R ceramic capacitor, P/N: C3225X7R2A105KT (TDK) or equivalent caps

C6: 0.1µF/100V X7R ceramic capacitor, P/N: 12101C104JAT2A (AVX) or equivalent caps

C8 ~ C11: 0.22µF/630V X7R ceramic capacitor, P/N: 2220CC224KA11A (AVX) or equivalent caps

C7: 470µF/100V electrolytic capacitor, P/N: UPM2A471MHD (Nichicon) or equivalent caps

C12: 750µF/50V electrolytic capacitor (150µF*5pcs), P/N: UUD1H151MNL1GS (Nichicon) or equivalent caps

PE: Connect to V_{o-}

Case: Not connected

Mechanical Diagram

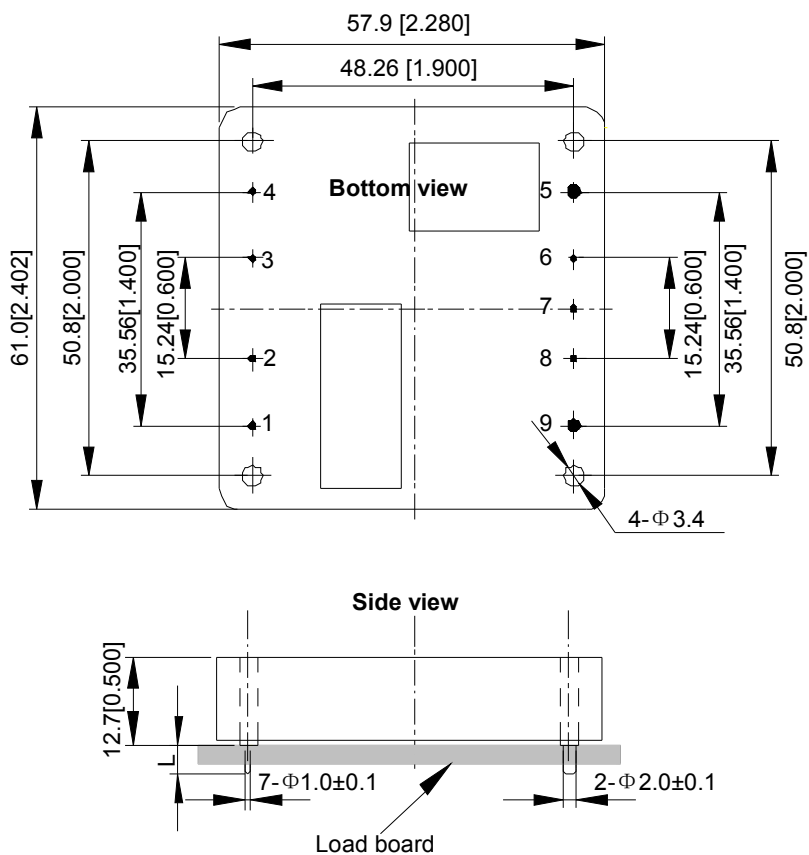

Unit: mm[inch] Bottom view: pin on upside

Tolerance: X.Xmm±0.5mm[X.X in.±0.02in.]
 X.XXmm±0.25mm[X.XX in.±0.01in.]

Figure 17 Mechanical diagram

Pin length option

Device code suffix	L
-4	4.8mm±0.2mm
-6	3.8mm±0.2mm
-8	2.8mm±0.2mm
None	5.8mm±0.2mm

Pin Designations

Pin NO.	Name	Function
1	V_{in+}	Positive input voltage
2	CNT	Remote control
3	Case	Pin connected to baseplate
4	V_{in-}	Negative input voltage
5	V_{o-}	Negative output voltage
6	S-	Negative sense
7	Trim	Output voltage trim
8	S+	Positive sense
9	V_{o+}	Positive output voltage

Soldering

The product is intended for standard manual or wave soldering.

When wave soldering is used, the temperature on pins is specified to maximum 255°C for R5 compliant product and maximum 260°C for R6 compliant product. And the duration must be less than 7s.

When soldering by hand, the iron temperature should be maintained at 300°C ~ 380°C and applied to the converter pins for less than 10s. Longer exposure can cause internal damage to the converter.

Cleaning of solder joint can be performed with cleaning solvent IPA or similitive.

Thermal Considerations

The converter is designed to operate in different thermal environments and sufficient cooling must be provided.

Application without forced air convection

Proper cooling of the DC/DC converter can be verified by measuring the temperature at the test points, shown in Figure 18. The temperature at these points should not exceed the max values in the table 1.

The converter can operate in an enclosed environment without forced air convection. Cooling of the converter is achieved mainly by conduction from the baseplate to a heatsink. The converter can deliver full output power at 85°C ambient temperature provided both temperature test points, shown in Figure 18, are kept below the max values in the Table 1.

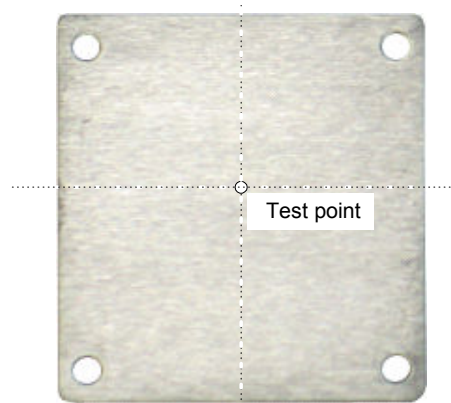

Figure 18 Temperature test point on baseplate

Table 1 Temperature limit of the test points

Test Point	Temperature limit
Test point on baseplate	105°C

Application with forced air convection

The converter can also operate with a smaller heatsink and sufficient airflow. Proper cooling of the DC/DC converter can be verified by measuring the temperature at the test points, shown in Figure 19. The temperature at these points should not exceed the max values in the table 1.

For a typical application, Figure 20 shows the derating output current vs. ambient air temperature at different air velocity with a specified heatsink (Size: L: 61mm, W: 58mm, H: 25.4mm), shown in Figure 19.

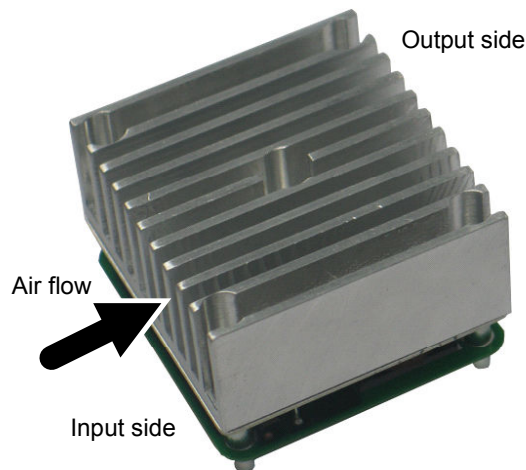

Figure 19 Typical application with a smaller heatsink and airflow

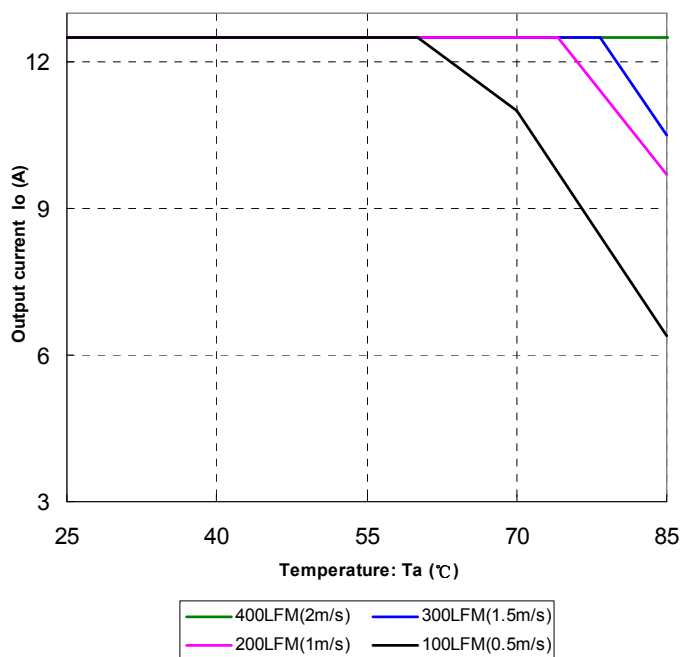

Figure 20 Output power derating, 48Vin

Ordering Information

AVE350B	-	48	S	28	P	-	6	L	/	M
①		②	③	④	⑤		⑥	⑦		⑧

①	Model series	AVE: high efficiency half brick series, 350: output power 350W, B:version
②	Input voltage	48: 36V ~ 75V input range, rated input voltage 48V
③	Output number	S: single output
④	Rated output voltage	28: 28V output
⑤	Remote ON/OFF logic	Default: negative; P: positive logic
⑥	Pin length	-6: 3.8mm
⑦	RoHS status	L: RoHS, R6; Y: RoHS, R5
⑧	Structure	Default: through hole; M: screw thread

Model number	Description
AVE350B-48S28-6	3.8mm pin length; negative on/off logic; with through mounting hole; R6 compliant

Hazardous Substances Announcement (RoHS Of China)

Parts	Hazardous substances					
	Pb	Hg	Cd	Cr ⁶⁺	PBB	PBDE
AVE350B-48S28-6	√	○	○	○	○	○
<p>○: Means the content of the hazardous substances in all the average quality materials of the part is within the limits specified in SJ/T-11363-2006</p> <p>√: Means the content of the hazardous substances in at least one of the average quality materials of the part is outside the limits specified in SJ/T11363-2006</p>						
<p>ASTECCo., Ltd. has been committed to the design and manufacturing of environment-friendly products. It will reduce and eventually eliminate the hazardous substances in the products through unremitting efforts in research. However, limited by the current technical level, the following parts still contain hazardous substances due to the lack of reliable substitute or mature solution:</p> <ol style="list-style-type: none"> 1. Solders (including high-temperature solder in parts) contain plumbum. 2. Glass of electric parts contains plumbum. 3. Copper alloy of pins contains plumbum 						