

Ureg



ureg.sch

ATmega328



atmega328.sch

connector

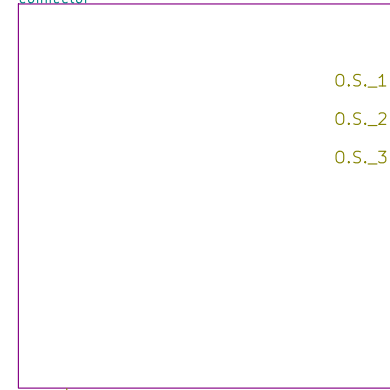

con.sch

0.S._1D PD2

0.S._2D PD3

0.S._3D PD4

GY88

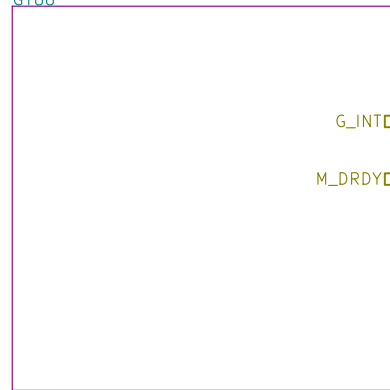

gy88.sch

G_INTD PD5

M_DRDYD PD6

microSD



microsd.sch

Sheet: /
File: Umweltdaten.sch

Title:

Size: A4

Date:

Rev:

KiCad E.D.A. kicad 0.201508170901+609728ubuntu14.04.1-product

Id: 1/6

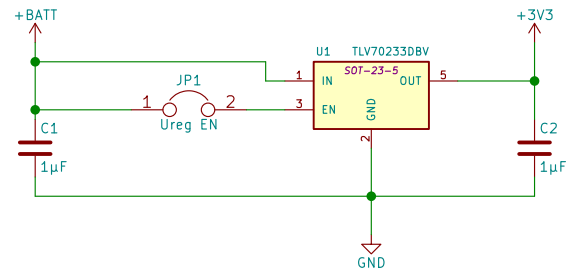
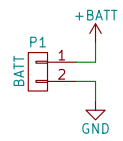

Sheet: /Ureg/		
File: ureg.sch		
Title:		
Size: A4	Date:	Rev:
KiCad E.D.A. kicad 0.201508170901+609728ubuntu14.04.1-product		Id: 2/6

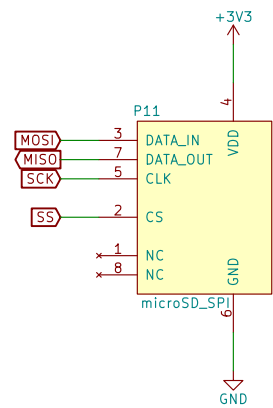

Sheet: /microSD/
 File: microsd.sch

Title:

Size: A4

Date:

Rev:

KiCad E.D.A. kicad 0.201508170901+609728ubuntu14.04.1-product

Id: 3/6

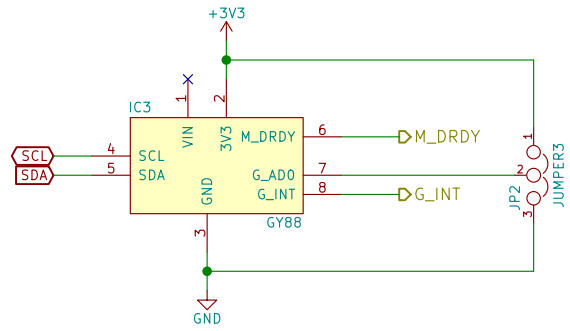

Sheet: /GY88/		
File: gy88.sch		
Title:		
Size: A4	Date:	Rev:
KiCad E.D.A. kicad 0.201508170901+609728ubuntu14.04.1-product		Id: 4/6

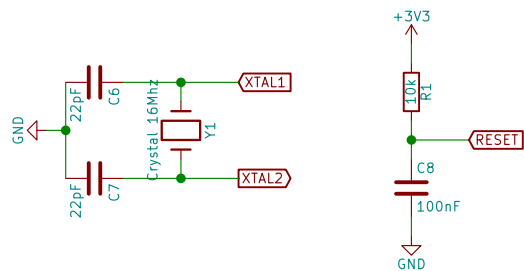
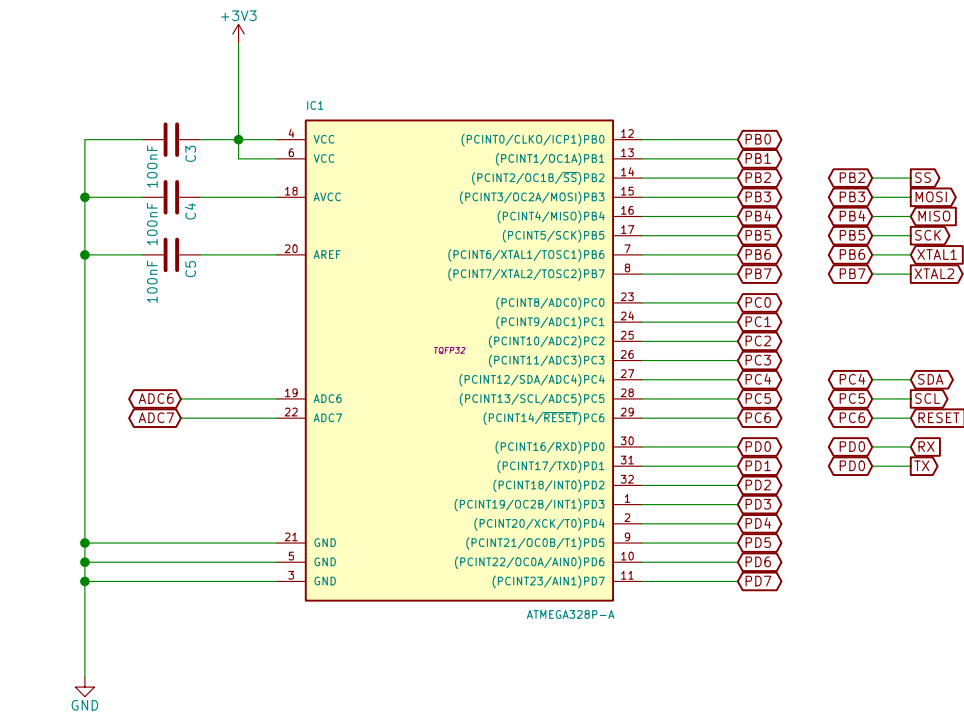

Sheet: /ATmega328/		Date:	
File: atmega328.sch		Rev:	
Size: A4	KiCad E.D.A. kicad 0.201508170901+609728ubuntu14.04.1-product		Id: 5/6

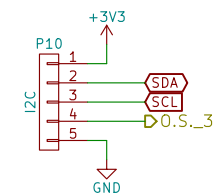
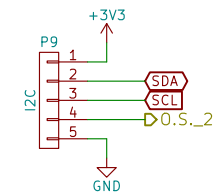
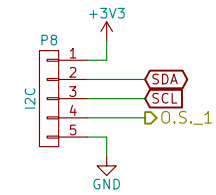
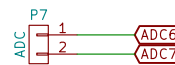
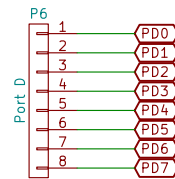
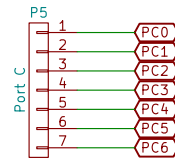
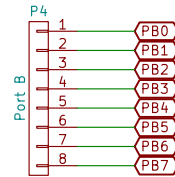
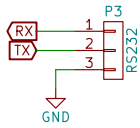
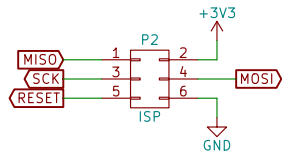

Sheet: /connector/
File: con.sch

Title:

Size: A4

Date:

Rev:

KiCad E.D.A. kicad 0.201508170901+609728ubuntu14.04.1-product

Id: 6/6