

Ureg



ureg.sch

ATmega328



atmega328.sch

connector

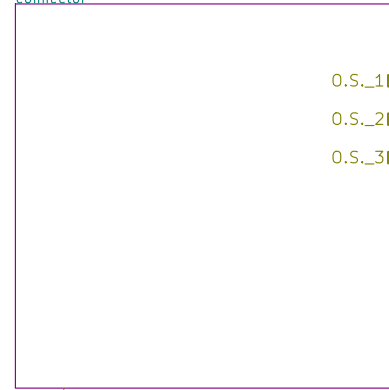

con.sch

GY88

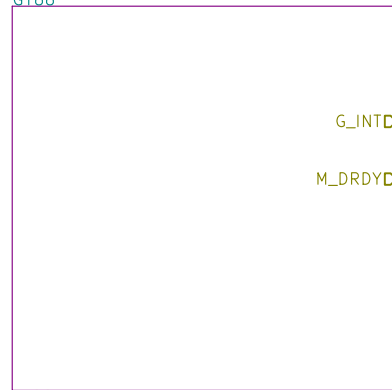

gy88.sch

microSD



microsd.sch

Sheet: /
File: Umweltdaten.sch

Title:

Size: A4 | Date: |
KiCad E.D.A. kicad 0.201508170901+609728ubuntu14.04.1-product

Rev: |
Id: 1/6

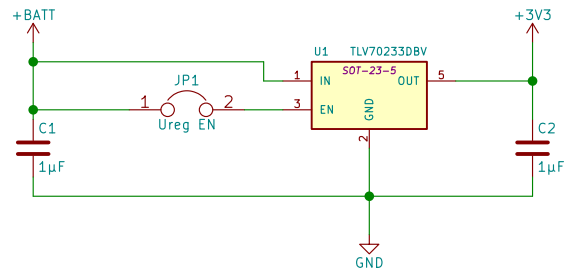
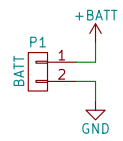

Sheet: /Ureg/
File: ureg.sch

Title:

Size: A4 Date:
KiCad E.D.A. kicad 0.201508170901+609728ubuntu14.04.1-product

Rev:
Id: 2/6

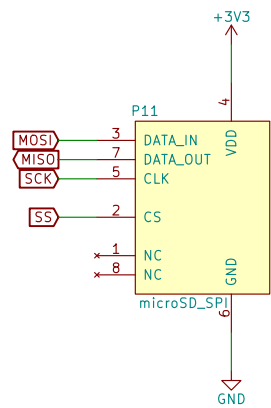

Sheet: /microSD/
 File: microsd.sch

Title:

Size: A4

Date:

Rev:

KiCad E.D.A. kicad 0.201508170901+609728ubuntu14.04.1-product

Id: 3/6

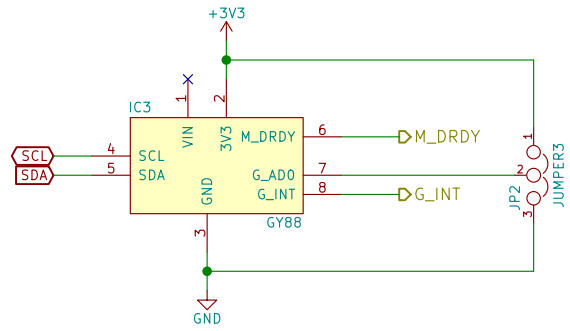

Sheet: /GY88/
 File: gy88.sch

Title:

Size: A4

Date:

Rev:

KiCad E.D.A. kicad 0.201508170901+609728ubuntu14.04.1-product

Id: 4/6

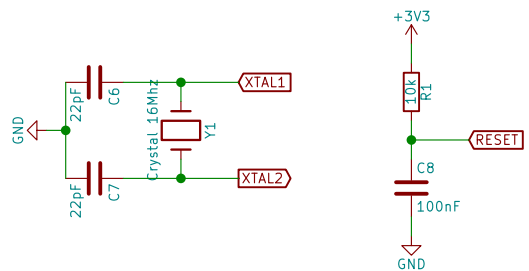
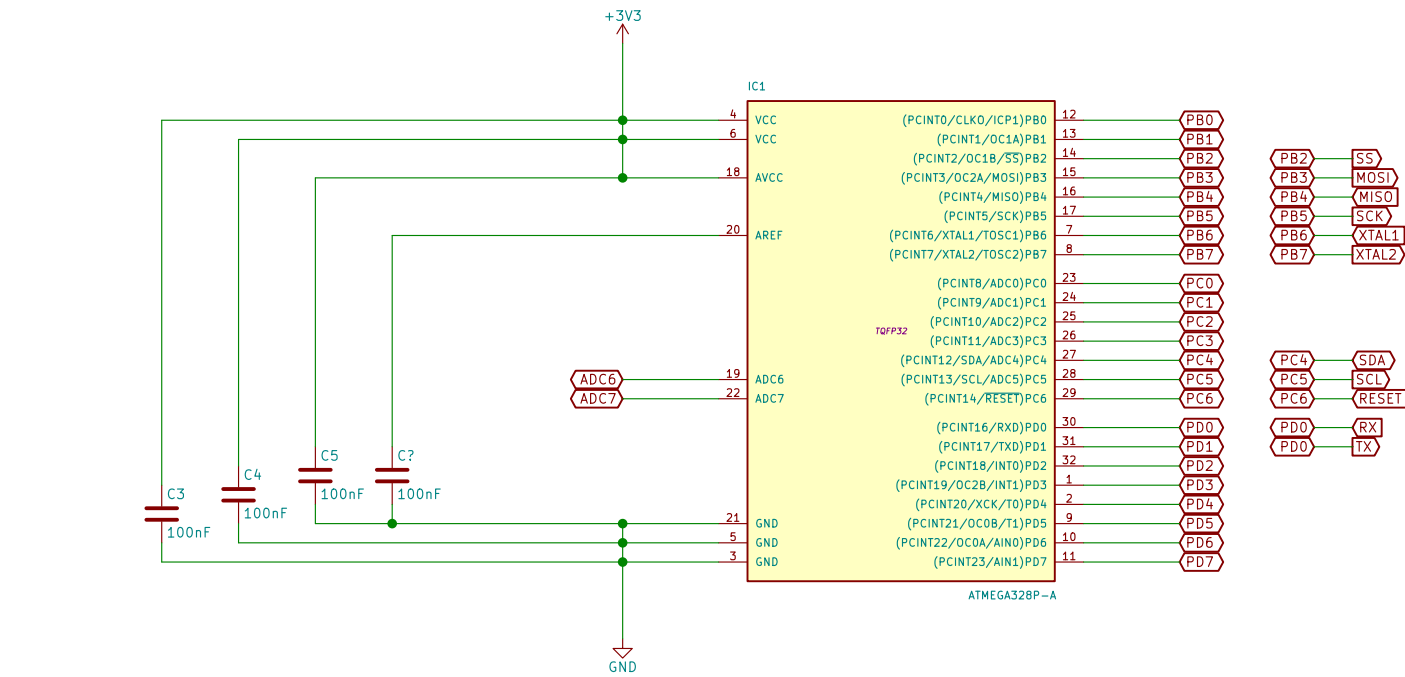

Sheet: /ATmega328/		Date:	
File: atmega328.sch		Rev:	
Size: A4	KiCad E.D.A. kicad 0.201508170901+609728ubuntu14.04.1-product		Id: 5/6

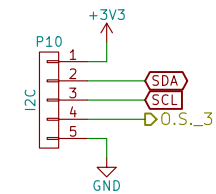
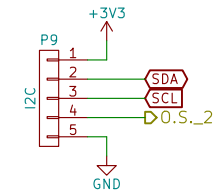
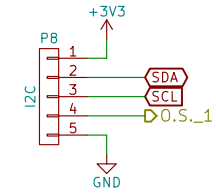
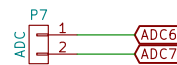
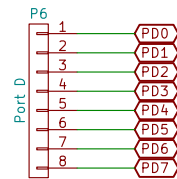
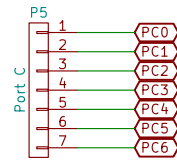
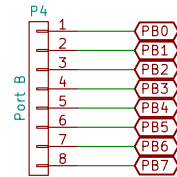
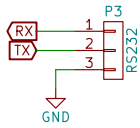
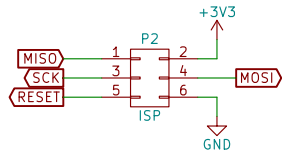

Sheet: /connector/
File: con.sch

Title:

Size: A4

Date:

Rev:

KiCad E.D.A. kicad 0.201508170901+609728ubuntu14.04.1-product

Id: 6/6