

SAM7-EX256

Development Board for the Atmel AT91SAM7X256 Microcontroller

User's Guide

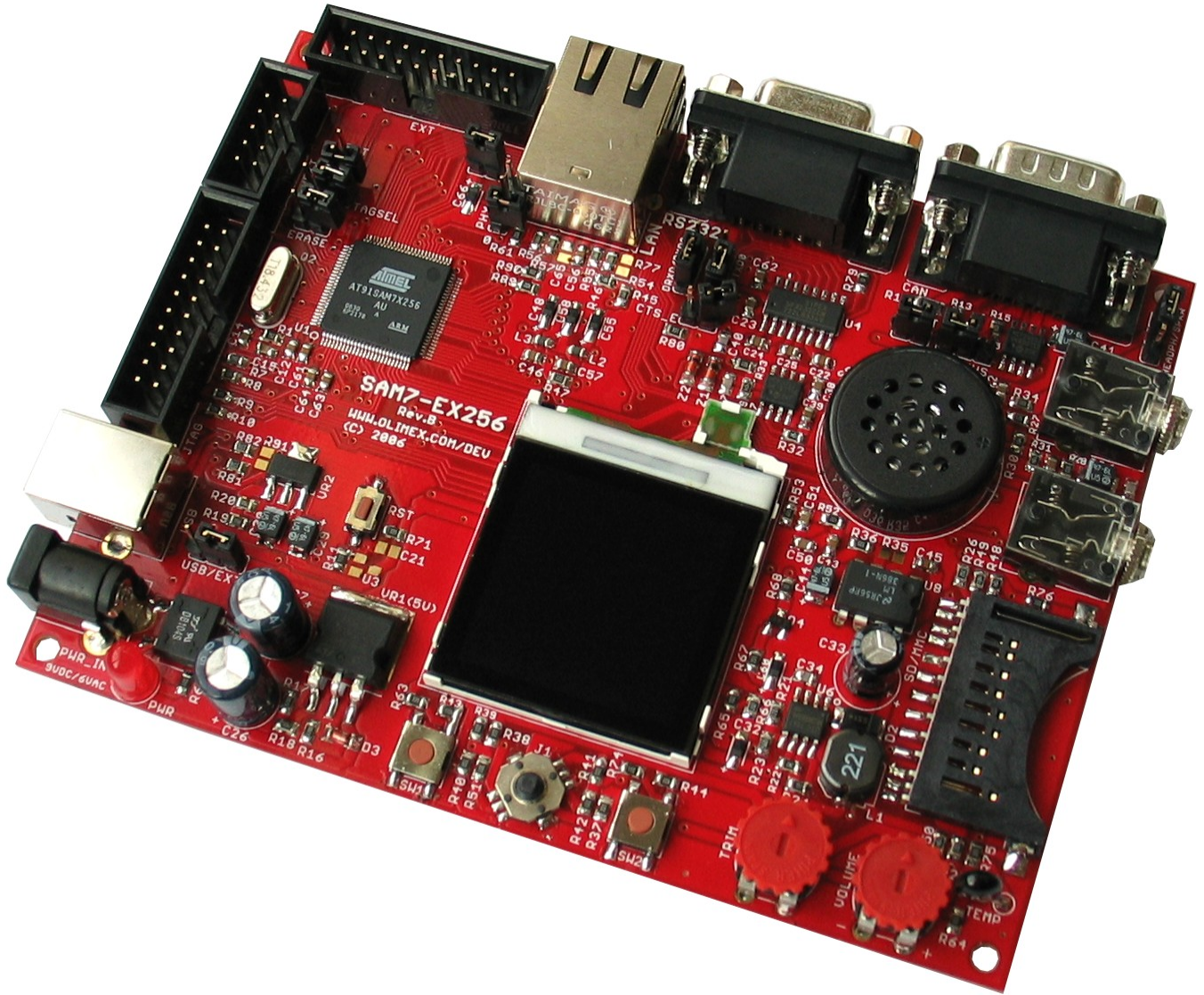



Disclaimer: The information in this document is provided in connection with Olimex products. No license, express or implied, by estoppel or otherwise, to any intellectual property right is granted by this document or in connection with the sale of Olimex products.

OLIMEX ASSUMES NO LIABILITY WHATSOEVER AND DISCLAIMS ANY EXPRESS, IMPLIED OR STATUTORY WARRANTY RELATING TO ITS PRODUCTS INCLUDING, BUT NOT LIMITED TO, THE IMPLIED WARRANTY OF MERCHANTABILITY, FITNESS FOR A PARTICULAR PURPOSE, OR NON-INFRINGEMENT. IN NO EVENT SHALL OLIMEX BE LIABLE FOR ANY DIRECT, INDIRECT, CONSEQUENTIAL, PUNITIVE, SPECIAL OR INCIDENTAL DAMAGES (INCLUDING, WITHOUT LIMITATION, DAMAGES FOR LOSS OF PROFITS, BUSINESS INTERRUPTION, OR LOSS OF INFORMATION) ARISING OUT OF THE USE OR INABILITY TO USE THIS DOCUMENT, EVEN IF OLIMEX HAS BEEN ADVISED OF THE POSSIBILITY OF SUCH DAMAGES.

Olimex makes no representations or warranties with respect to the accuracy or completeness of the contents of this document and reserves the right to make changes to specifications and product descriptions at any time without notice. Olimex does not make any commitment to update the information contained herein. Unless specifically provided otherwise, Olimex products are not suitable for, and shall not be used in, automotive applications. Olimex's products are not intended, authorized, or warranted for use as components in applications intended to support or sustain life.

© 2007 Olimex Ltd. All rights reserved. Olimex®, logo and combinations thereof, are registered trademarks of Olimex Ltd. SAM-BA™ and others are trademarks of Atmel Corporation or its subsidiaries. ARM®, the ARM Powered® logo and others are the registered trademarks or trademarks of ARM Ltd. I²C™ is a trademark of Koninklijke Philips Electronics NV. SPI™ is registered trademark of Motorola Corporation. Other terms and product names may be trademarks of others.



Printed on recycled paper.

Table of Contents

Table of Contents	iii
Overview	1
1.1 Scope	1
1.2 Features	1
1.3 Organization	2
Setting Up the SAM7-EX256 Development Board	1
2.1 Electrostatic Warning	1
2.2 Requirements	1
2.3 Powering Up the Board	2
2.4 Getting Started	2
SAM7-EX256 Board Description	1
3.1 Block Diagram	1
3.2 Layout	3
The AT91SAM7X256 Microcontroller	1
4.1 Features	1
4.2 Block Diagram	4
Control Circuitry	1
5.1 Power Supply Circuitry	1
5.1.1 Power Source Selection	1
5.1.2 LCD Backlight	1
5.2 Reset Circuitry	1
5.2.1 Reset Controller	1
5.3 Clock Circuitry	2
Busses	1
6.1 Communication Busses	1
6.1.1 MII Bus	1
6.1.2 SPI Bus	2
6.1.3 I2C™/TWI Bus	2
6.1.4 Serial Synchronous Bus	3
6.2 Peripheral Busses	3
6.2.1 Bus A	4
6.2.2 Bus B	5
Peripherals	1
7.1 LCD Screen	1
7.1.1 Backlight	2
7.2 User Inputs	2

7.2.1 Joystick.....	2
7.2.2 Switches.....	2
7.3 SD/MMC Card.....	2
7.3.1 Card Present.....	3
7.3.2 Write Protect.....	3
7.4 Ethernet.....	3
7.4.1 PHY Power Down.....	3
7.5 Slave USB.....	3
7.5.1 USB Present.....	4
7.5.2 USB Disconnect.....	4
7.6 RS232.....	4
7.6.1 RX/TX/CTS Selection.....	5
7.7 CAN.....	5
7.7.1 Standby/HS Selection.....	5
7.7.2 Termination Selection.....	5
7.8 Analog Audio.....	5
7.8.1 Microphone Interface.....	5
7.8.2 Audio Output Interface.....	5
7.9 Temperature Sensor.....	6
7.10 Analog Inputs.....	6
7.10.1 VREF Selection.....	6
<hr/>	
Debug Interface.....	1
8.1 JTAG/ICE.....	1
8.1.1 EmbeddedICE™.....	1
8.1.2 IEEE 1149.1 JTAG Boundary Scan.....	1
8.1.3 JTAGSEL Selection.....	1
8.1.4 Common JTAG/ICE Port.....	1
DBGU Serial Debug.....	2
8.2 Test and Debug Pins.....	2
8.2.1 JTAGSEL Selection.....	2
8.2.2 ERASE Selection.....	2
8.2.3 TST Selection.....	2
<hr/>	
Connectors.....	1
9.1 Power Connector.....	1
9.2 LCD Connector.....	1
9.3 Ethernet Connector.....	2
9.4 USB Connector.....	2
9.5 SD/MMC Connector.....	3
9.6 RS232 Connector.....	3
9.7 CAN Bus Connector.....	4
9.8 Microphone Connector.....	4
9.9 Headphones Connector.....	5
9.10 Extension Connectors.....	5
9.10.1 EXT Connector.....	5
9.10.2 UEXT Connector.....	6

9.11 JTAG Connector.....	6
<hr/>	
Configuration Straps.....	1
10.1 Power Configuration.....	1
10.2 Ethernet Configuration.....	1
10.3 RS232 Configuration.....	2
10.3.1 DRXD/RXD0 Configuration Strap.....	2
10.3.2 DTXD/TXD0 Configuration Strap.....	2
10.3.3 CTS_E Configuration Strap.....	3
10.4 CAN Configuration.....	3
10.4.1 STNB/HS Configuration Strap.....	3
10.4.2 CAN_T Configuration Strap.....	3
10.5 Audio Configuration.....	4
10.6 Analog Configuration.....	4
10.7 JTAG Configuration.....	5
10.7.1 JTAGSEL Configuration Strap.....	5
10.7.2 ERASE Configuration Strap.....	5
10.7.3 TST Configuration Strap.....	5
<hr/>	
Memory.....	1
11.1 Memory.....	1
11.1.1 Flash Memory.....	1
11.1.2 SRAM Memory.....	1
11.1.3 ROM Memory.....	1
<hr/>	
Schematics.....	1
12.1 Schematics.....	1
<hr/>	
Mechanical Drawings.....	1
13.1 Mechanical Drawings.....	1
<hr/>	
Index.....	3
Revision History.....	1

Section 1

Overview

Thank you for choosing the SAM7-EX256 development board from Olimex!

This document provides a User's Guide for the Olimex SAM7-EX256 development board.

As an overview, this chapter gives the scope of this document and lists the board's features.

The document's organization is then detailed.

1.1 Scope

The SAM7-EX256 development board enables code development of applications running on the Atmel AT91SAM7X256 microcontroller.

This guide focuses on the SAM7-EX256 board as a development platform for the AT91SAM7X256 device in a 100-lead LQFP package.

1.2 Features

The SAM7-EX256 development board provides a rich development platform for the Atmel AT91SAM7X256 microcontroller.

The board's main features are:

- Microcontroller: Atmel AT91SAM7X256 16/32 bit ARM7TDMI™ with:
 - 256K Bytes Program Flash
 - 64K Bytes RAM
 - 1x CAN 2.0a and 2.0b
 - 1x USB Device v 2.0
 - 1x Ethernet 10/100 Mbps
 - 1x RTT (Real Time Timer/Clock)
 - 1x 8-channel 10 bit ADC 384 ksp/s
 - 2x UARTs
 - 1x TWI (I²C™)
 - 2x SPI™
 - 3x 32bit timers
 - 4x PWM outputs
 - 1x SSC (Synchronous Serial Controller)
 - 1x WDT (WatchDog Timer)
 - PDC (DMA) for all peripherals
 - Up to 55 MHz operation
- Standard JTAG connector with ARM 2x10 pin layout for programming/debugging with ARM-JTAG
- Nokia® 6610 128x128 pixel TFT 12 bit color LCD with back light
- Ethernet 10/100 PHY with Micrel KS8721BL chip
- USB type B Device connector
- One channel RS232 interface and drivers (a second RS232 interface without driver is routed to the UEXT extension connector)

- One CAN 2.0b interface and driver
- SD/MMC card connector
- Joystick with 4 direction and push action
- Two buttons
- Audio in and audio out 3.5mm jacks for microphone and headphones
- Onboard speaker with volume control potentiometer
- Trim potentiometer connected to ADC
- Thermistor connected to ADC
- Onboard 3.3V voltage regulator with up to 800mA output current
- Single power supply: 6V AC or 9V DC required; the board can also take power from USB port
- Power supply LED
- Power supply filtering capacitors
- RESET circuit, RESET button
- 18.432 MHz crystal on socket
- Two Extension headers for all microcontroller ports
- Olimex's cross-compatible "Universal Extension" Header (UEXT)
- Additional Extension Header (EXT)
- PCB: FR-4, 1.5 mm (0,062"), solder mask, silkscreen component print
- Dimensions: 128 x 98 mm (5 x 3.8")

1.3 Organization

Each section in this document covers a separate topic, organized as follow:

- Section 1 is an overview of the board usage and features
- Section 2 provides a guide for quickly setting up the board
- Section 3 contains the general board diagram and layout
- Section 4 describes the component that is the heart of the board: the Atmel AT91SAM7X256 microcontroller
- Section 5 is a detailed explanation of the control circuitry associated with the microcontroller to reset, power and clock the board
- Section 6 covers the different communication busses that link the microcontroller and the different peripherals on the board
- Section 7 browses though all the peripherals included on the board
- Section 8 details the different connector pinout
- Section 9 enumerates the different configuration straps present on the board and their usage
- Section 10 gives information on the board's debug interface
- Section 11 is the board's memory map
- Section 12 holds the board's schematics
- Section 13 provides the board's mechanical drawings
- Section 14 is an index
- Section 15 contains the document's revision history

Setting Up the SAM7-EX256 Development Board

This section helps you set up the SAM7-EX256 development board for the first time.

Please consider first the electrostatic warning to avoid damaging the board, then discover the hardware and software required to operate the board.

The procedure to power up the board is given, and a description of the default board behavior is detailed.

2.1 Electrostatic Warning

The SAM7-EX256 development board is shipped in a protective anti-static package. The board must not be exposed to high electrostatic potentials. A grounding strap or similar protective device should be worn when handling the board. Avoid touching the component pins or any other metallic element.

2.2 Requirements

In order to set up the SAM7-EX256 evaluation board, the following items are required:

- the SAM7-EX256 development board itself
- an A/B-type USB cable connected to an USB host or hub

Or

- an external power adapter (6VAC/9VDC at 0.1A)

Note: The board is not delivered with a JTAG/ICE interface which is required to start developing on the device. You may use one of the following devices for this purpose:

- Olimex's [ARM-JTAG](#)
- Olimex's [ARM-USB_OCD](#)
- Olimex's [ARM-USB-TINY](#)
- Olimex's ARM-USB-OCD-H
- Olimex's [ARM-USB-TINY-H](#)
- Olimex's [ARM-JTAG-EW](#)

Or any other third-party ARM® JTAG/ICE compatible tool.

Also, a host-based software toolchain is required in order to program/debug the SAM7-EX256 board. Visit one of the links in the list above to find available open-source or commercial solutions.

2.3 Powering Up the Board

The SAM7-EX256 board is self-powered by the USB port or by an external 6VAC/9VDC 0.1A power adapter.

The board has no power switch; just plug/unplug the power/USB cable to/from the board to cycle power.

2.4 Getting Started

From Olimex's website you can download the following software and documents:

- [eLua](#) - Lua language project build for SAM7-EX256 with GCC and OpenOCD
- Native hardware support by **eCOS** the anonymous eCos CVS tree has this target inside 'sam7ex256' eCos target . Here is the link to [eCos 3.0](#) the [announcement](#). The instructions how to install eCos 3.0 on [Linux](#) and [Windows](#)
- [demo code LCD write, Joystick and buttons read](#) Note: NOKIA6610 comes with two type of controllers, the difference is in the label on the display GE8 and GE12, this project handles both controllers, but you have to comment (#define GE12) if your LCD is GE8, separate BIN files are generated for download for [GE8](#) and [GE12](#)
- [TCP-IP code with FreeRTOS](#)
- [BMP-TO-ARRAY converter for Nokia 6610 LCD](#)
- Jim Lynch's [NOKIA 6610 LCD tutorial](#)
- Ting Chen Hanson's [eForth implementation for SAM7-EX256](#), demo bin code is available for free download
- [OpenOCD + Eclipse set of projects 1.00](#) include flash write make file for SAM7-EX25

SAM7-EX256 Board Description

This section helps you to understand the different board logical blocks and locate them physically on the printed circuit board.

3.1 Block Diagram

Figure 3-1- SAM7-EX256 Block Diagram

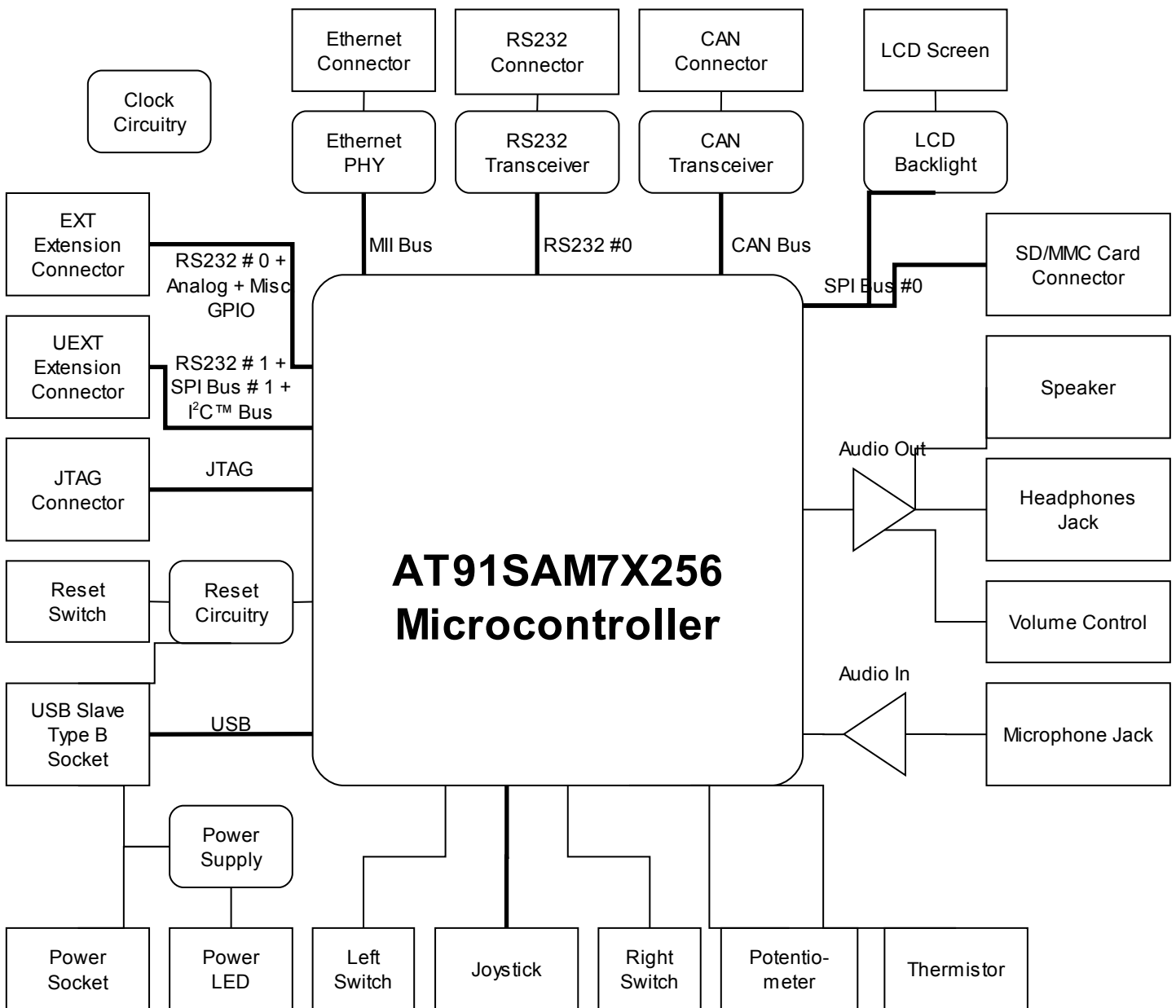

3.2 Layout

Figure 3-2. Board Layout

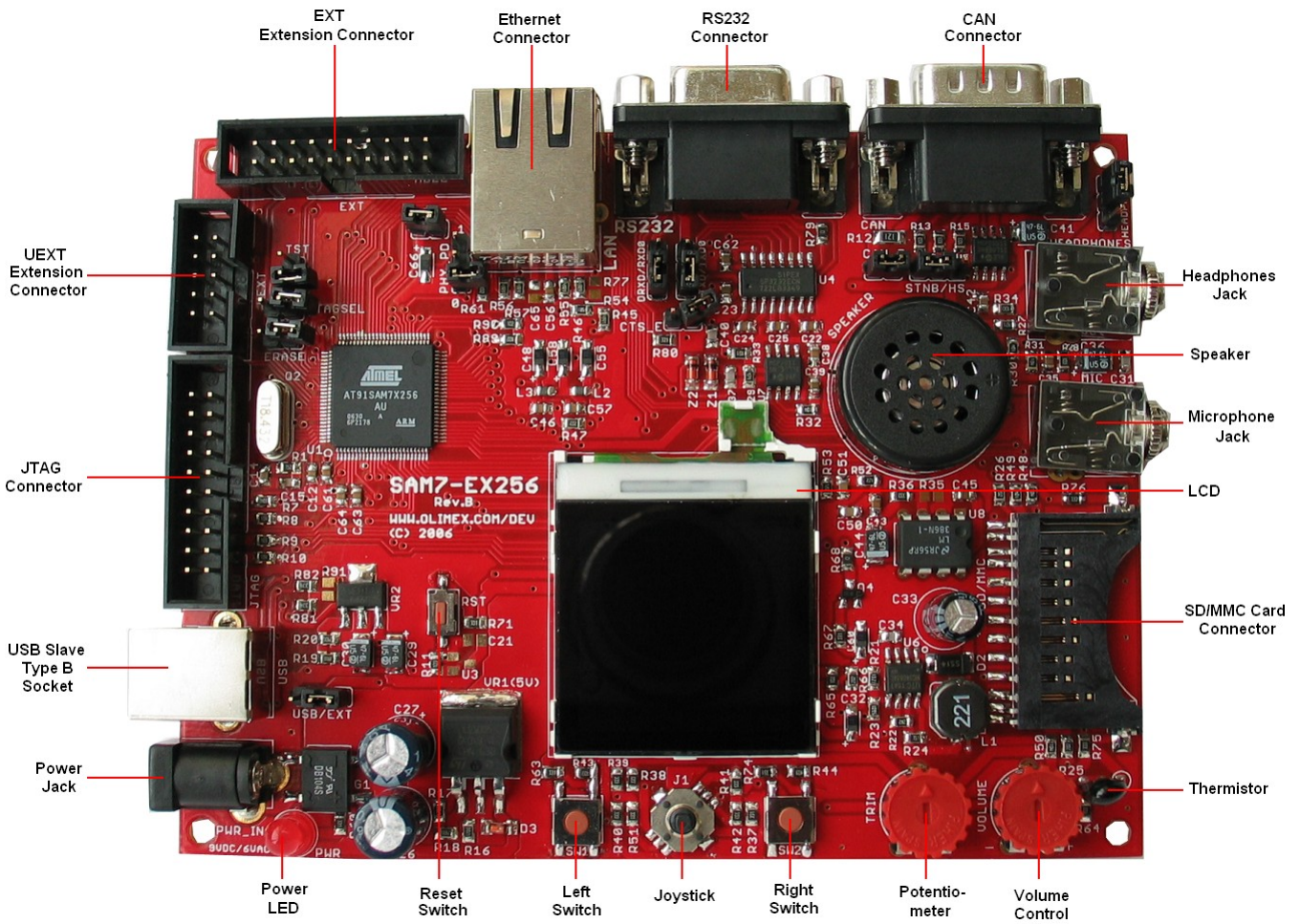

The AT91SAM7X256 Microcontroller

This section focuses on the heart of the SAM7-EX256 board: the Atmel AT91SAM7X256 microcontroller.

The microcontroller features are listed, and a block diagram is given.

4.1 Features

Atmel's AT91SAM7X256 is a member of a series of highly integrated Flash microcontrollers based on the 32-bit ARM® RISC processor. It features 256 Kbyte high-speed Flash and 64 Kbyte SRAM, a large set of peripherals, including an 802.3 Ethernet MAC and a CAN controller. A complete set of system functions minimizes the number of external components.

By combining the ARM7TDMI® processor with on-chip Flash and SRAM, and a wide range of peripheral functions, including USART, SPI, CAN Controller, Ethernet MAC, Timer Counter, RTT and Analog-to-Digital Converters on a monolithic chip, the AT91SAM7X256 is a powerful device that provides a flexible, cost-effective solution to many embedded control applications requiring communication over Ethernet, USB, CAN and RS232.

Here are the AT91SAM7X256 features:

- ARM7TDMI® ARM® Thumb® Processor
 - High-performance 32-bit RISC Architecture
 - High-density 16-bit Instruction Set
 - Leader in MIPS/Watt
 - EmbeddedICE™, Debug Communication Channel Support
 - 256 Kbytes Internal High-speed Flash
 - Organized in 1024 Pages of 256 Bytes
 - Single Cycle Access at Up to 30 MHz in Worst Case Conditions
 - Prefetch Buffer Optimizing Thumb Instruction Execution at Maximum Speed
 - Page Programming Time: 6 ms, including Page Auto-erase, Full Erase Time: 15 ms
 - 10,000 Write Cycles, 10-year Data Retention Capability, Sector Lock Capabilities, Flash Security Bit
 - Fast Flash Programming Interface for High Volume Production
 - 64 Kbytes Internal High-speed SRAM, Single-cycle Access at Maximum Speed
 - Memory Controller (MC)
 - Embedded Flash Controller, Abort Status and Misalignment Detection
 - Reset Controller (RSTC)
 - Based on Power-on Reset Cells and Low-power Factory-calibrated Brownout Detector
 - Provides External Reset Signal Shaping and Reset Source Status
 - Clock Generator (CKGR)
 - Low-power RC Oscillator, 3 to 20 MHz On-chip Oscillator and one PLL
 - Power Management Controller (PMC)
 - Power Optimization Capabilities, Including Slow Clock Mode (Down to 500 Hz) and Idle Mode
 - Four Programmable External Clock Signals
-

- Advanced Interrupt Controller (AIC)
 - Individually Maskable, Eight-level Priority, Vectored Interrupt Sources
 - Two External Interrupt Sources and One Fast Interrupt Source, Spurious Interrupt Protected
 - Debug Unit (DBGU)
 - 2-wire UART and Support for Debug Communication Channel interrupt, Programmable ICE Access Prevention
 - Periodic Interval Timer (PIT)
 - 20-bit Programmable Counter plus 12-bit Interval Counter
 - Windowed Watchdog (WDT)
 - 12-bit key-protected Programmable Counter
 - Provides Reset or Interrupt Signals to the System
 - Counter May Be Stopped While the Processor is in Debug State or in Idle Mode
 - Real-time Timer (RTT)
 - 32-bit Free-running Counter with Alarm
 - Runs Off the Internal RC Oscillator
 - Two Parallel Input/Output Controllers (PIO)
 - Sixty-two Programmable I/O Lines Multiplexed with up to Two Peripheral I/Os
 - Input Change Interrupt Capability on Each I/O Line
 - Individually Programmable Open-drain, Pull-up Resistor and Synchronous Output
 - Seventeen Peripheral DMA Controller (PDC) Channels
 - One Advanced Encryption System (AES)
 - 128-bit Key Algorithm, Compliant with FIPS PUB 197 Specifications
 - Buffer Encryption/Decryption Capabilities with PDC
 - One USB 2.0 Full Speed (12 Mbits per second) Device Port
 - On-chip Transceiver, 1352-byte Configurable Integrated FIFOs
 - One Ethernet MAC 10/100 base-T
 - Media Independent Interface (MII) or Reduced Media Independent Interface (RMII)
 - Integrated 28-byte FIFOs and Dedicated DMA Channels for Transmit and Receive
 - One Part 2.0A and Part 2.0B Compliant CAN Controller
 - Eight Fully-programmable Message Object Mailboxes, 16-bit Time Stamp Counter
 - One Synchronous Serial Controller (SSC)
 - Independent Clock and Frame Sync Signals for Each Receiver and Transmitter
 - I²S Analog Interface Support, Time Division Multiplex Support
 - High-speed Continuous Data Stream Capabilities with 32-bit Data Transfer
 - Two Universal Synchronous/Asynchronous Receiver Transmitters (USART)
 - Individual Baud Rate Generator, IrDA® Infrared Modulation/Demodulation
 - Support for ISO7816 T0/T1 Smart Card, Hardware Handshaking, RS485 Support
 - Full Modem Line Support on USART1
 - Two Master/Slave Serial Peripheral Interfaces (SPI)
-

- 8- to 16-bit Programmable Data Length, Four External Peripheral Chip Selects
- One Three-channel 16-bit Timer/Counter (TC)
- Three External Clock Inputs, Two Multi-purpose I/O Pins per Channel
 - Double PWM Generation, Capture/Waveform Mode, Up/Down Capability
 - One Four-channel 16-bit Pulse Width Modulation Controller (PWMC)
 - One Two-wire Interface (TWI)
 - Master Mode Support Only, All Two-wire Atmel EEPROMs Supported
 - One 8-channel 10-bit Analog-to-Digital Converter, Four Channels Multiplexed with Digital I/Os
 - SAM-BA™ Boot Assistance
 - Default Boot program
 - Interface with SAM-BA™ Graphic User Interface
 - IEEE® 1149.1 JTAG Boundary Scan on All Digital Pins
 - 5V-tolerant I/Os, Including Four High-current Drive I/O lines, Up to 16mA Each
 - Power Supplies
 - Embedded 1.8V Regulator, Drawing up to 100mA for the Core and External Components
 - 3.3V VDDIO I/O Lines Power Supply, Independent 3.3V VDDFLASH Flash Power Supply
 - 1.8V VDDCORE Core Power Supply with Brownout Detector
 - Fully Static Operation: Up to 55 MHz at 1.65V and 85°C Worst Case Conditions
 - Available in a 100-lead LQFP Green Package

4.2 Block Diagram

Figure 4-3. Block Diagram

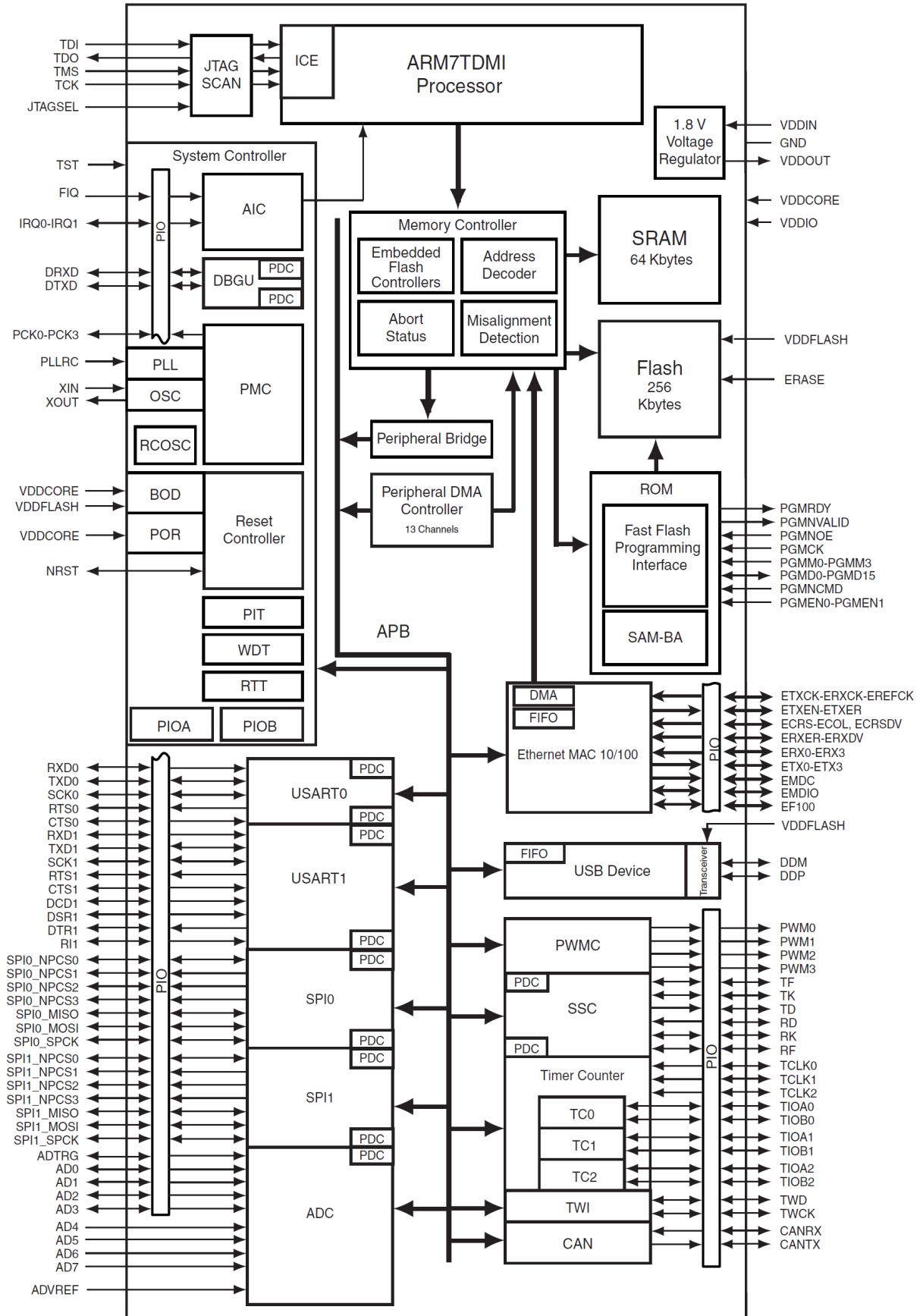

Section 5

Control Circuitry

Along with the microcontroller, a separate control circuitry is required to pace the board. This section details the power supply, reset and clock circuitry.

5.1 Power Supply Circuitry

The SAM7-EX256 board integrates a regulated power supply that sources power either from the USB bus or from an external 9V DC/6V AC (0.1A) power adapter.

The main power supply components are:

- A standard power socket
- An integrated bridge rectifier **G1**
- An RC1587 adjustable 3A LDO (Low Drop-Out) regulator set to 5V output **VR1**
- An LM1117 3.3V/800mA LDO regulator **VR2**
- A power LED
- A power source selection jumper **USB/EXT**
- An MC34063 adjustable/1.5A Boost/Buck switching regulator for the LCD backlight power supply, set to 7V output **U6**

5.1.1 Power Source Selection

The power source must be selected by setting the jumper **USB/EXT** to either USB or external power source. See §10.1 for details.

5.1.2 LCD Backlight

As the LCD technology by itself does not deliver any light, an additional backlight circuitry must provide a light source for correct display.

The Nokia® 6610 LCD screen integrates such backlight LEDs; these must be fed with a 7V voltage, supplied by the Boost switching regulator **U6**.

5.2 Reset Circuitry

The SAM7-EX256 board integrates both an automatic and a manual RESET circuitry:

- An MCP130 Reset controller **U3** provides an automatic RESET signal (not mounted by default)
- A manual **RST** switch allows the user to reset the board when required

5.2.1 Reset Controller

When mounted, the MCP130 Reset controller **U3** is able to monitor the supply voltage and to trigger a clean Reset signal when the supply voltage drops below a safe operating voltage, then releases the Reset signal after a minimum delay when the power supply reaches a higher voltage, thus avoiding spurious Reset generation when the supply voltage drops momentarily ("brown-out" detection).

5.3 Clock Circuitry

The SAM7-EX256 board clock is using a socketed 18.432MHz crystal **Q2** as the main clock source. This particular frequency was chosen, as it allows the use of the Atmel SAM-BA™ protocol over USB upon power on to bootstrap the microcontroller.

A crystal with a different frequency (from 3 MHz up to 20 MHz) may be used when required by replacing the existing crystal in the socket.

The AT91SAM7X256 microcontroller derives its main clock frequency from the crystal clock by using a built-in PLL (Phase-Locked Loop), up to 55MHz operation.

The KS8721BL Ethernet PHY chip **U2** uses a separate 25MHz crystal **Q3** for its own operation.

This section explains the different communication busses that link the microcontroller and the different peripherals included on the SAM7-EX256 board. The AT91SAM7X256 peripheral busses are also covered.

6.1 Communication Busses

The SAM7X-EX development board integrates several communication busses for its operation:

- An MII (Media Independent Interface) bus for communicating with the KS8721BL PHY Ethernet chip **U2**
- Two SPI (Serial Peripheral Interface) busses:
 - one for communicating with the SD/MMC card and the LCD screen
 - one routed to extension connector
- An I²C™ (Inter Integrated Circuit) or TWI (Two-Wire Interface) bus
- An SS (Serial Synchronous) bus

6.1.1 MII Bus

The MII (Media Independent Interface) bus is used to communicate between the AT91SAM7X256 microcontroller **U1** and the KS8721BL Ethernet PHY chip **U2**.

This bus is running at a clock frequency of 25MHz, derived from the crystal **Q3**.

This bus is only present on the board and not routed to any connector.

This bus consists in the following signal lines on the SAM7-EX256 board:

Table 1 - MII Bus

Signal Name	Description
MDC	MII Clock
MDIO	MII Data I/O
REFCK	MII Transmit Clock
RXD[0..3]	MII Receive Data
RXCK	MII Receive Clock
RXDV	MII Received Data Valid
RXER	MII Receive Error
TX[0..3]	MII Transmit Data
TXEN	MII Transmit Enable
TXER	MII Transmit Error

Note: Although both the AT91SAM7X256 microcontroller and the KS8721BL Ethernet PHY chip support the RMII (Reduced Media Independent Interface) bus that use less signal lines, this solution has been discarded because this interface is not functional in the AT91SAM7X256 microcontroller (see datasheet errata).

6.1.2 SPI Bus

The SPI (Simple Peripheral Interface) bus is a very common low pin count communication interface bus in the microcontroller world.

The AT91SAM7X256 microcontroller integrates two such busses, and acts as a bus master on both, driving the following onboard peripherals on SPI bus 0:

- SD/MMC Card
- Nokia® 6610 LCD screen

The SPI bus 1 is not used internally, but is routed to the extension connector **UEXT**. See §9.10.2 for details.

The SPI bus 0 consists in the following signal lines on the SAM7-EX256 board:

Table 2 – SPI 0 Bus

Signal Name	Description
CS_LCD	SPI 0 LCD Chip Select
CS_MMC	SPI 0 SD/MMC Card Chip Select
MISO0	SPI 0 Master In / Slave Out
MOSI0	SPI 0 Master Out / Slave In
SCK0	SPI 0 Clock

The SPI bus 1 consists in the following signal lines on the SAM7-EX256 board:

Table 3 - SPI 1 Bus

Signal Name	Description
MISO1	SPI 1 Master In / Slav Out
MOSI1	SPI 1 Master Out / Slave In
SCK1	SPI 1 Clock
SPI1_CS0	SPI 1 Chip Select 0

6.1.3 I²C™/TWI Bus

The I²C™ (Inter Integrated Circuit) bus is another very common low pin count interface bus in the microcontroller world. It is called TWI (Two-Wire Interface) bus by Atmel.

The AT91SAM7X256 microcontroller integrates one such bus (operating in master mode only).

This bus is not used on the SAM7-EX256 board, but is routed to the extension connector **UEXT**. See §9.10.2 for details.

The I²C™/TWI bus consists in the following signals lines on the SAM7-EX256 board:

Table 4 - I2C™/TWI Bus

Signal Name	Description
TWC	Two-Wire Clock
TWD	Two-Wire Data

6.1.4 Serial Synchronous Bus

The AT91SAM7X256 microcontroller features one SSC (Serial Synchronous Controller), that provides a serial synchronous communication link, commonly used in audio (IIS or AC'97 bus) or telecom applications.

This bus is not used on the SAM7-EX256 board, but is routed to the extension connector **UEXT**, although multiplexed with SPI bus 1. See §9.10.2 for details.

The Serial Synchronous bus consists in the following signal lines on the SAM7-EX256 board:

Table 5 - SS Bus

Signal Name	Description
RD (MISO1)	SSB Receive Data
TD (MOSI1)	SSB Transmit Data
TF (SPI1_CS0)	SSB Transmit Frame
TK (SCK1)	SSB Transmit Clock

Note: The following Serial Synchronous bus signal lines are not routed on the SAM7-EX256 board:

Table 6 - SS Bus (Not routed)

Signal Name	Description
RF	SSB Receive Frame
RK	SSB Receive Clock

As these signals can be switched internally in the AT91SAM7X microcontroller from the **TK** and **TF**, respectively, this bus may still be useful.

6.2 Peripheral Busses

The AT91SAM7X256 microcontroller features two PIO controllers (PIOA and PIOB), each controlling a peripheral bus, made up of 31 signal lines. Each individual line can be configured to be used as a GPIO (General Purpose Input/Output), or be assigned to several dedicated purposes (pin "multiplexing").

6.2.1 Bus A

The following table defines the alternative purposes for bus A pins:

Table 7 - Peripheral Bus A

GPIO Line	Purpose A	Purpose B	Board Signal Function	Comment
PA0	RXD0		RXD0	RS232 0 Receive
PA1	TXD0		TXD0	RS232 0 Transmit
PA2	SCK0	SPI1_NPCS1	LCD_RESET	LCD Reset
PA3	RTS0	SPI1_NPCS2	PA3/RTS0	PA3/RS232 0 RTS
PA4	CTS0	SPI1_NPCS3	PA4/CTS0	PA4/RS232 0 CTS
PA5	RXD1		RXD1	RS232 1 Receive
PA6	TXD1		TXD1	RS232 1 Transmit
PA7	SCK1	SPI0_NPCS1	B1	Joystick Up
PA8	RTS1	SPI0_NPCS2	B2	Joystick Push
PA9	CTS1	SPIO0_NPCS3	B3	Joystick Left
PA10	TWD		TWD	I ² C™ Data
PA11	TWCK		TWC	I ² C™ Clock
PA12	SPI0_NPCS0		CS_LCD	LCD Chip Select
PA13	SPIO0_NPCS1	PCK1	CS_MMC	SD/MMC Chip Select
PA14	SPIO0_NPCS2	IRQ1	B4	Joystick Right
PA15	SPIO0_NPCS3	TCLK2	B5	Joystick Down
PA16	SPIO0_MISO		MISO0	SPI 0 Master In/Slave Out
PA17	SPIO0_MOSI		MOSI0	SPI 0 Master Out/Slave In
PA18	SPIO_SPCK		SCK0	SPI 0 Clock
PA19	CANRX		CANRX	CAN Receive
PA20	CANTX		CANTX	Can Transmit
PA21	TF	SPI1_NPCS0	SPI1_CS0	SPI 1 Chip Select 0
PA22	TK	SPI1_SPCK	SCK1	SPI 1 Clock
PA23	TD	SPI1_MOSI	MOSI1	SPI 1 Master Out/Slave In
PA24	RD	SPI1_MISO	MISO1	SPI 1 Master In/Slave Out
PA25	RK	SPI1_NPCS1	USB_PUP	USB Pull Up
PA26	RF	SPI1_NPCS2	USB_PR	USB Present
PA27	DRXD	PCK3	PA27/DRXD	PA27/Debug Receive

PA28	DTXD		PA28/DTXD	PA28/Debug Transmit
PA29	FIQ	SPI1_NPCS3	PA29/FIQ	PA29/ Fast Interrupt
PA30	IRQ0	PCK2	PA30/IRQ	PA30/Interrupt ReQuest

Note: The grayed cells represent the default SAM7-EX256 board usage of the multiplexed Peripheral A Bus pin.

6.2.2 Bus B

The following table defines the alternative purpose for bus B pins:

Table 8 - Peripheral Bus B

GPIO Line	Purpose A	Purpose B	Board Signal Function	Comment
PB0	ETXCK/EREFCK		REFCK	Ethernet Reference Clock
PB1	ETXEN		TXEN	Ethernet TX Enable
PB2	ETX0		TX0	Ethernet TX0
PB3	ETX1		TX1	Ethernet TX1
PB4	ECRS		CRS	Ethernet Carrier Sense
PB5	ERX0		RX0	Ethernet RX0
PB6	ERX1		RX1	Ethernet RX1
PB7	ERXER		RXER	Ethernet RX Error
PB8	EMDC		MDC	Ethernet Management Data Clock
PB9	EMDIO		MDIO	Ethernet Management Data I/O
PB10	ETX2	SPI1_NPCS1	TX2	Ethernet TX2
PB11	ETX3	SP1_NPCS2	TX3	Ethernet TX3
PB12	ETXER	TCLK0	TXER	Ethernet TX Error
PB13	ERX2	SPIO0_NPCS1	RX2	Ethernet RX2
PB14	ERX3	SPIO0_NPCS2	RX3	Ethernet RX3
PB15	ERXDV/ECRSDV		RXDV	Ethernet RX Data Valid
PB16	ECOL	SPI1_NPCS3	COL	Ethernet Collision Detect
PB17	ERXCK	SPI0_NPCS3	RXCK	Ethernet RX Clock
PB18	EF100	ADTRG	PB18/PHY_PD	Ethernet PHY Power down
PB19	PWM0	TCLK1	AUDIO_OUT	Audio Out PWM
PB20	PWM1	PCK0	LCD_BL	LCD Backlight PWM
PB21	PWM2	PCK1	PB21	PB21
PB22	PWM3	PCK2	PB22/WP	PB22 SD/MMC Card Write Protect

PB23	TIOA0	DCD1	PB23/CP	PB23 SD/MMC Card Present
PB24	TIOB0	DSR1	SW1	User Left Switch
PB25	TIOA1	DTR1	SW2	User Right Switch
PB26	TIOB1	RI1	PHY_IRQ	Ethernet PHY Interrupt ReQuest
PB27	TIOA2	PWM0	PB27/AD0	PB27/Analog Input 0
PB28	TIOB2	PWM1	PB28/AD1	PB28/Analog Input 1
PB29	PCK1	PWM2	PB29/AD2	PB29/Analog Input 2
PB30	PCK2	PWM3	PB30/AD3	PB30/Analog Input 3

Note: The grayed cells represent the default SAM7-EX256 board usage of the multiplexed Peripheral B Bus pin.

Section 7

Peripherals

This section gives a detailed explanation of the different peripherals included on the SAM7-EX256 board.

7.1 LCD Screen

The SAM7-EX256 development board integrates a Nokia® 6610-compatible LCD screen.

This screen is a graphical 132 x 132 pixel TFT 12 bit color LCD with an integrated display controller and backlight LEDs. Because of its use in cellular phones, this screen is both easy-to-find and low-cost.

However, the drawback is that Nokia® 6610 LCD screens come in two different types, having the same physical dimensions and pinout, but using two different display controllers:

- Those labeled “GE8” and having a green connector are equipped with an Epson® S1D15G00 controller
- Those labeled “GE12” and having an orange connector are equipped with a Philips® PCF8833 controller

For example software on how to drive the LCD screen, please check the files “lcd.h” and “lcd.c” in the following archive:

http://www.olimex.com/dev/soft/arm/SAM7/SAM7_EX256.zip

You will have to uncomment the following line in the “lcd.h” file if you use a screen equipped with the Philips® PCF8833 controller:

```
//#define GE12
```

Change it to:

```
#define GE12
```

There is also two precompiled binaries available, one for each controller type:

http://www.olimex.com/dev/soft/arm/SAM7/SAM7_EX256_GE8.zip

http://www.olimex.com/dev/soft/arm/SAM7/SAM7_EX256_GE12.zip

The LCD screen is plugged on the board using two mated 10-pin 0.5mm pitch low-profile Hirose DF23 connectors. For pinout, refer to §9.2.

The LCD screen is connected to the AT91SAM7X256 microcontroller using the SPI 0 bus and a few other GPIO signals:

- **SCK0 (PA18)**: SPI 0 Serial Clock
- **MOSI0 (PA17)**: SPI 0 Master Out / Slave In
- **MISO0 (PA16)**: SPI 0 Master In / Slave Out
- **CS_LCD (PA12)**: LCD Chip Select
- **LCD_RESET (PA2)**: LCD Reset (Active Low)
- **LCD_BL (PB20)**: LCD backlight

Note: The SPI bus 0 is shared with the SD/MMC Card functionality.

7.1.1 Backlight

As the LCD technology does not emit any light by itself, the Nokia® 6610 screen integrates LEDs for providing a backlight illumination.

These LEDs must be fed with a 7V DC power supply. This voltage is derived from the 5V DC power by using an MC34063 1.5A Step-Up switching regulator **U6**.

Backlight is controlled by the AT91SAM7X256 microcontroller using the **LCD_BL** signal that drives a transistor **Q4** to loop the LED supply voltage down to ground.

Note: As the microcontroller output used for the **LCD_BL** signal is the microcontroller's **PB20/PWM1/PCK0** pin, it is possible to vary the backlight intensity (and power consumption) by using a PWM (Pulse Width Modulation) signal and modifying the duty cycle.

7.2 User Inputs

User inputs are provided on the SAM7-EX256 board by the mean of one mini digital joystick **J1** and two pushbuttons **SW1** and **SW2**.

For example software on how to use the user inputs, please check the file "main_all.c" in the following archive:

http://www.olimex.com/dev/soft/arm/SAM7/SAM7_EX256.zip

7.2.1 Joystick

The joystick is a low-profile, low-cost four-directional center-push multifunctional ALPS® SKRH tact switch, one of the most compact in the industry.

The joystick **J1** provides five digital signal inputs to the AT91SAM7X256 microcontroller:

- **B1 (PA7): up**
- **B2 (PA8): center push**
- **B3 (PA9): left**
- **B4 (PA14): down**
- **B5 (PA15): right**

7.2.2 Switches

Two tact switches **SW1** and **SW2** provide two digital inputs to the AT91SAM7X256 microcontroller:

- **SW1 (PB24): left switch**
- **SW2 (PB25): right switch**

7.3 SD/MMC Card

One SD/MMC connector is present on the SAM7-EX256 development board that enables the user to plug any SD/MMC compatible card to provide mass Flash storage and/or extended I/O capabilities.

Despite the fact that the SD-Card standard makes provision for several low to high speed communication interfaces, the SAM7-EX256 board only uses the low-speed SPI interface. As the AT91SAM7X256 microcontroller does not have a dedicated full-speed SD/MMC interface, this is the only practical way of interfacing this type of card.

Thus, the SD/MMC card connector is interfaced to the AT91SAM7X256 using the SPI bus 0 and a few other signals:

- **PB22/WP:** SD/MMC Card Write Protect Switch
- **CS_MMC (PA13):** SD/MMC Card Chip Select
- **MOSI0 (PA17):** SPI 0 Master Out / Slave In
- **SCK0 (PA18):** SPI 0 Clock
- **MISO0 (PA16):** SPI 0 Master In / Slave Out
- **PB23/CP:** SD/MMC Card Present Switch

Note: The SPI bus 0 is shared with the LCD functionality.

For example software on how to drive the SD/MMC interface, please check the files "mmc.h" and "mmc.c" in the following archive:

http://www.olimex.com/dev/soft/arm/SAM7/SAM7_EX256.zip

7.3.1 Card Present

The SD/MMC Card connector's "Card Present" switch is forwarded to the AT91SAM7X256 **PB23** input, allowing detection of card insertion.

7.3.2 Write Protect

The SD/MMC Card connector's "Write Protect" switch is forwarded to the AT91SAM7X256 **PB22** input, allowing sensing the card's write protection.

7.4 Ethernet

The SAM7-EX256 development board integrates a fully-compliant IEEE 802.3u 10/100Mbps wired Ethernet interface.

This functionality is provided by the combination of:

- The AT91SAM7X256 built-in 10/100Mbps Ethernet MAC
- The 10/100Mbps Ethernet PHY KS8721BL **U2**, with built-in voltage regulator for single-supply operation
- A 10/100Mbps RJ45 Ethernet connector with built-in transformers, EMI filters and status LEDs

The Ethernet PHY KS821BL chip **U2** is interfaced to the AT91SAM7X256 microcontroller using an MII bus. For a complete description of the involved signals, please refer to §6.1.1.

Note: Although both the AT91SAM7X256 microcontroller and the KS8721BL PHY Ethernet chip support the RMII (Reduced Media Independent Interface) bus that use less signal lines, this solution has been discarded because this interface is not functional in the AT91SAM7X256 microcontroller.

The Ethernet PHY KS821BL chip **U2** requires a separate 25MHz crystal **Q3** for its operation. The Ethernet PHY chip drives the two LEDs built into the Ethernet connector as follow:

- Left LED (Green): Ethernet activity
- Right LED (Yellow): 100Mbps link when LED is on, 10Mbps link when LED is off

Note: By unsoldering resistor **R62** and soldering a 330 ohms resistor **R58**, the right LED (Yellow) can be changed to signal full/half duplex operation instead of link speed.

For example software to provide TCP/IP functionality with FreeRTOS, see the following archive:

http://www.olimex.com/dev/soft/arm/SAM7/SAM7_EX256_FreeRTOSV4.0.zip

7.4.1 PHY Power Down

By moving the **PHY_PD** configuration strap, it is possible to permanently enable/disable the Ethernet PHY chip, or leave this control to software using the **PB18/PHY_PD** signal.

For more details on how to set this configuration strap, see §10.2.

7.5 Slave USB

The SAM7-EX256 development board features an USB Type B receptacle. Taking advantage of the AT91SAM7X256's integrated USB device peripheral, a fully compliant USB 2.0 full-speed (12Mbps/s) device capability can be added to the application.

The USB connector can be used to provide a bus-powered operation to the board, if the configuration strap **USB/EXT** is set accordingly.

For example software demonstrating how to operate the AT91SAM7X256 USB peripheral, please refer to the following Atmel application note and related software:

http://www.atmel.com/dyn/resources/prod_documents/doc6263.pdf

http://www.atmel.com/dyn/resources/prod_documents/AT91%20USB%20Framework%20-%20Core%201.01.zip

7.5.1 USB Present

As a convenience, the SAM7-EX256 development board is equipped with a digital input **USB_PR (PA26)** to the AT91SAM7X256 microcontroller providing indication whether an USB cable with power is plugged-in or not, through the use of a resistor divider **R72/R73**.

7.5.2 USB Disconnect

In order to provide automatic USB disconnection upon reset or under software control, the USB 1.5Kohms pull-up resistor **R4** can be disabled, either by the board RST signal, or under software control by the **USB_PUP (PA25)** output signal.

7.6 RS232

The AT91SAM7X256 microcontroller contains three separate USARTs (Universal Synchronous/Asynchronous Receiver/Transmitter):

- A simple two-wire debug serial interface that can be used to bootstrap the microcontroller using the SAM-BA™ protocol
- A more sophisticated serial interface (USART0) with the following signals:

Table 9 - USART0

Signal Name	Description
CTS0	USART 0 Clear To Send input
RTS0	USART 0 Request To Send output
RXD0	USART 0 Received Data input
TXD0	USART 0 Transmit Data output

- A complete serial interface (USART1) with the following signals:

Table 10 - USART1

Signal Name	Description
CTS1	USART 1 Clear To Send input
DCD1	USART 1 Data Carrier Detect input
DSR1	USART 1 Data Set Ready input
DTR1	USART 1 Data Terminal Ready output
RI1	USART 1 Ring Detect input
RTS1	USART 1 Request To Send output
RXD1	USART 1 Received Data input
TXD1	USART 1 Transmit Data output

Both USART0 and USART1 feature individual baud rate generators and support for IrDA® infrared modulation/demodulation, ISO7816 T0/T1 Smart Card and RS485.

On the SAM7-EX256 development board, these serial interfaces are routed to different connectors:

- The simple debug serial interface is routed to the RS232 transceiver and standard DB9 female connector and to the **EXT** connector. For pinout, please refer to §9.10.1
- The USART0 serial interface is routed to the same RS232 transceiver and DB9 connector and its RTS0 and CTS0 signals are also routed to the **EXT** connector. For pinout, please refer to §9.10.1
- The USART1 serial interface **RXD1** and **TXD1** signals are routed to the **UEXT** connector. For pinout, please refer to §9.10.2

Note: the USART1 signals **CTS1**, **DCD1**, **DSR1**, **DTR1**, **RI1** and **RTS1** are not available on the SAM7-EX256 board.

The signals on the DB9 connector are at the standard RS232 level (-12V to +12V). These voltages are obtained by using a standard MAX3232 RS232 transceiver with integrated capacitive charge pump **U4**.

The signals present on the **EXT** and **UEXT** connectors are LVTTTL (0V to +3.3V) compatible.

RS232 works at 9600 bits per second.

For example software on how to drive the serial interface, please check the files “usart.h” and “usart.c” in the following archive:

http://www.olimex.com/dev/soft/arm/SAM7/SAM7_EX256.zip

7.6.1 RX/TX/CTS Selection

As both the simple debug serial interface and the USART0 are routed to the RS232 transceiver and DB9 connector, the **DTXD/TXD0** and **DRXD/RXD0** configuration straps provide a way to select the desired operation. For further details, please refer to §10.3.1 and §10.3.2.

The **CTS_E** configuration strap allows enable/disable routing the **CTS0** to the RS232 transceiver and connector. For further details, please refer to §10.3.3.

7.7 CAN

The AT91SAM7X256 microcontroller integrates a part 2.0A and 2.0B compliant CAN controller. Along with the MCP2551 CAN transceiver **U5** and a DB9 male connector, the SAM7-EX256 development board provides a fully compliant CAN interface, including both 12V and 24V operation at up to 1Mbits/s.

7.7.1 Standby/HS Selection

The **STDB/HS** configuration strap allows putting the CAN transceiver in standby, high-speed or slope-control mode. For further details, please refer to §10.4.1.

7.7.2 Termination Selection

The **CAN_T** configuration strap enables/disables the CAN 120 ohms termination resistor. For further details, please refer to §10.4.2.

7.8 Analog Audio

Although the AT91SAM7X256 microcontroller does not provide specific support for audio, the SAM7-EX256 board adds a mono microphone input and a mono headphones/speaker output capability.

For example software on how to use the audio subsystem, please check the files “main.c”, “adc.h” and “adc.c” in the following archive:

http://www.olimex.com/dev/soft/arm/SAM7/SAM7_EX256.zip

7.8.1 Microphone Interface

On the SAM7-EX256 development board, the microphone interface is built around the MCP601 operational amplifier **U7**, used as a microphone pre-amplifier that feed the analog audio signal on the 3.5mm microphone input jack to one of the microcontroller analog input **AD7**. The analog to digital conversion must be performed by software in the microcontroller itself.

7.8.2 Audio Output Interface

The SAM7-EX256 development board provides an audio output capability by taking a software-generated digital PWM (Pulse Width Modulation) output signal **AUDIO_OUT (PB19)** and convert it to audible frequencies using a filter and a power amplifier built around the LM386 audio amplifier **U8**, then feed it either to the built-in speaker or the output 3.5mm jack.

7.8.2.1 Headphone/Speaker Selection

The configuration strap **HEADPH/SPKR** enables to choose between headphones or speaker output. For further configuration details, please refer to §10.5.

7.8.2.2 Volume Control

A built-in **VOLUME** potentiometer enables setting the audio output volume.

7.9 Temperature Sensor

The SAM7-EX256 development board features a built-in thermistor that provides an analog voltage proportional to the ambient temperature. This **AN_TERM** signal is fed to one of AT91SAM7X256's analog input **AD5**.

For example software on how to read the temperature, please check the files "main.c", "adc.h" and "adc.c" in the following archive:

http://www.olimex.com/dev/soft/arm/SAM7/SAM7_EX256.zip

7.10 Analog Inputs

The AT91SAM7X256 microcontroller features a built-in ADC (Analog to Digital Converter) with 8 multiplexed inputs, capable of converting voltages from 0V up to **VREF** voltage. Analog inputs **AD[0..3]** are multiplexed with other functions on peripheral Bus B, and analog inputs **AD[4..7]** are present on dedicated pins.

On the SAM7-EX256 board, only the **AD[4..7]** signals are used as analog inputs, some of them being dedicated to specific usage:

- **AD4** is not used on the SAM7-EX256 board, but is routed to the **EXT** connector. For pinout, please refer to §9.10.1
- **AD5** is used as the Thermistor analog input. See §7.9 for details
- **AD6** is connected to an on-board trim potentiometer
- **AD7** is used as an analog microphone input. See §7.8.1 for details

For example software on how to drive read the trim potentiometer value, please check the files "main.c", "adc.h" and "adc.c" in the following archive:

http://www.olimex.com/dev/soft/arm/SAM7/SAM7_EX256.zip

7.10.1 VREF Selection

The configuration strap **VREF** can be used to set the reference voltage required by the built-in ADC to +3.3V, disable the ADC voltage reference, or set it to a user-supplied voltage.

This section details the SAM7-EX256 development board debug interface. The AT91SAM7X256 features several debug and test capabilities:

- An EmbeddedICE™ (Embedded In-circuit Emulator)
- An IEEE 1149.1 JTAG Boundary Scan
- A DBGU (DeBuG Unit)
- Some pins dedicated to test and debug (**JTAGSEL**, **ERASE** and **TST**)

8.1 JTAG/ICE

8.1.1 EmbeddedICE™

The ARM7TDMI EmbeddedICE™ is supported via the ICE/JTAG port. The internal state of the ARM7TDMI is examined through an ICE/JTAG port.

8.1.2 IEEE 1149.1 JTAG Boundary Scan

IEEE 1149.1 JTAG Boundary Scan allows pin-level access independent of the device packaging technology.

To obtain a Boundary-Scan Description file, visit:

http://www.atmel.com/dyn/resources/prod_documents/AT91SAM7X256_bsd.zip.

8.1.3 JTAGSEL Selection

The configuration strap **JTAGSEL** enables/disables the EmbeddedICE™. For further configuration details, please refer to §10.7.1.

- EmbeddedICE™ mode is selected when **JTAGSEL** signal is low
- IEEE 1149.1 JTAG Boundary Scan mode is selected when **JTAGSEL** signal is high

It is not possible to switch directly between ICE and JTAG operations. A chip reset must be performed after **JTAGSEL** is changed.

8.1.4 Common JTAG/ICE Port

The common JTAG/ICE (In-Circuit Emulator) port is used for standard debugging functions, such as downloading code and single-stepping through programs.

The port consists in a SAM-ICE connector is a 20-way Insulation Displacement Connector (IDC) keyed box header (2.54 mm male) that mates with IDC sockets mounted on a ribbon cable.

This connector provides all the JTAG signals to/from the AT91SAM7X256 microcontroller, allowing IEEE 1149.1 JTAG Boundary Scan and EmbeddedICE™ programming and debugging:

- **VTref (3.3V)**: Target reference voltage
 - **Vsupply (3.3V)**: supply voltage
 - **nTRESET**: JTAG reset input
 - **TDI**: JTAG Test Data Input
 - **TMS**: JTAG Test Mode Set input
 - **TCK**: JTAG Test Clock input
 - **RTCK**: JTAG Return Test Clock
 - **TDO**: JTAG Test Data Output
 - **RESET**: Target CPU RESET
-

■ **GND:** Common GrouND

For detailed pinout, please refer §9.11.

DBGU Serial Debug

The Debug Unit provides a two-pin (**DXRD** and **TXRD**) USART that can be used for several debug and trace purposes and offers an ideal means for in-situ programming solutions and debug monitor communication. Moreover, the association with two peripheral data controller channels permits packet handling of these tasks with processor time reduced to a minimum.

8.2 Test and Debug Pins

The dedicated AT91SAM7X256 test and debug pins are routed to configuration straps on the SAM7-EX256 development board.

8.2.1 JTAGSEL Selection

The JTAGSEL configuration strap is covered in §8.1.3.

8.2.2 ERASE Selection

The **ERASE** configuration strap allows erasing the AT91SAM7X256 microcontroller's Flash memory. For further configuration details, please refer to §10.7.2.

8.2.3 TST Selection

The **TST** configuration strap enables/disables the fast programming mode (parallel or serial). For further configuration details, please refer to §10.7.110.7.3.

Note: Because the required signals are not routed on the SAM7-EX256 development board, the fast parallel programming mode is not available.

Section 9

Connectors

This section details the SAM7-EX256 development board connector pinout.

9.1 Power Connector

Figure 9-4 – Power Supply Connector

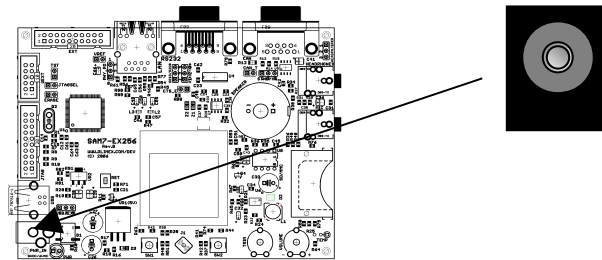

The power supply connector is suitable for both standard 9V DC or 6V AC power adapters, because of its unique design with an integrated diode bridge rectifier.

Because of this bridge rectifier, the input is not polarized if used with a DC power adapter.

9.2 LCD Connector

Figure 9-5 - LCD Connector

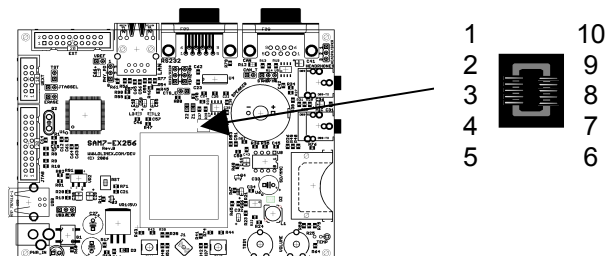

The LCD connection is realized by using a pair of matching Hirose DF-23 low-profile 2x5 SMT connectors.

Note: The following pinout applies to the board connector.

Table 11 - LCD Connector

Pin #	Signal Name	Pin #	Signal Name
1	VDIGITAL	6	VDISPLAY
2	LCD_RESET	7	NC
3	MOSI0	8	GND
4	SCK	9	LEDGND
5	CS_LCD	10	VLCD

9.3 Ethernet Connector

Figure 9-6 - Ethernet Connector

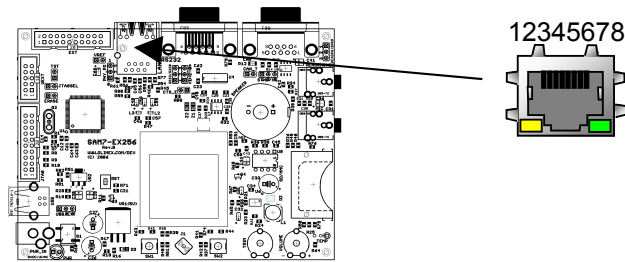

The Ethernet connector is a standard RJ45 socket with integrated magnetics, EMI filters and LEDs.

Table 12 - Ethernet Connector

Pin #	Signal Name	Pin #	Signal Name
1	TX+	5	NC
2	TX-	6	NC
3	Vdd	7	RX+
4	NC	8	RX-

The LEDs are used as follow:

Table 13 -Ethernet LEDs

LED	Color	Usage
Right	Yellow	Activity
Left	Green	100Mbits/s (Half/Full duplex)

9.4 USB Connector

Figure 9-7 - USB Connector

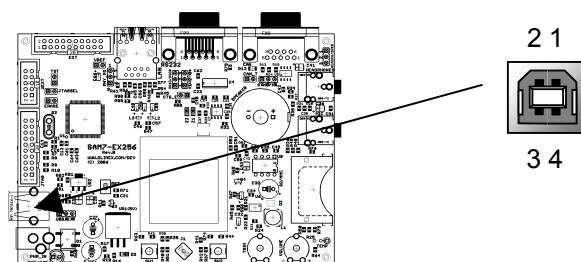

The USB connector is a standard USB Type B socket.

Table 14 - USB Connector

Pin #	Signal Name	Pin #	Signal Name
1	+5V_USB	3	DDP
2	DDM	4	GND

9.5 SD/MMC Connector

Figure 9-8 - SD/MMC Connector

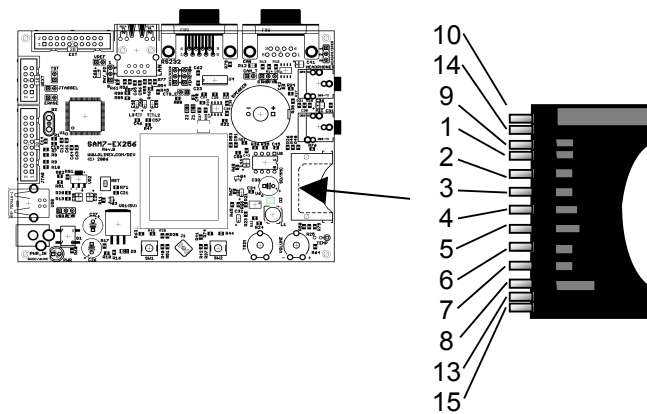

The SD/MMC connector is a manual-insertion SD/MMC compatible socket, with card detect and write protects switches.

Table 15 - SD/MMC Connector

Pin #	Signal Name	Pin #	Signal Name
1	CS_MMC	9	RESERVED
2	MOSI0	10	WP_PU
3	GND	11	NC
4	3.3V	12	NC
5	SCK0	13	CP_PD
6	GND	14	WP
7	MISO0	15	CP
8	RESERVED		

9.6 RS232 Connector

Figure 9-9 - RS232 Connector

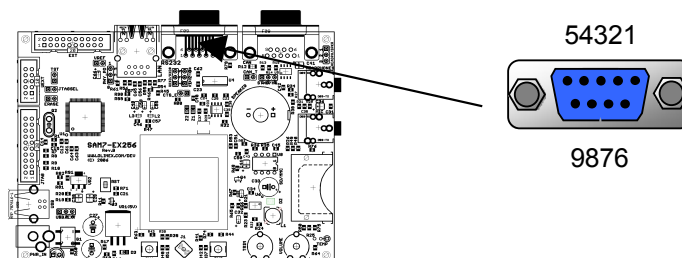

The RS232 connector is a standard DB9 female connector.

Note: Don't get confused with the CAN DB9 male connector!

Table 16 - RS232 Connector

Pin #	Signal Name	Pin #	Signal Name
-------	-------------	-------	-------------

1	NC	6	NC
2	TxD	7	CTS
3	RxD	8	RTS
4	NC	9	NC
5	GND		

9.7 CAN Bus Connector

Figure 9-10 - CAN Bus Connector

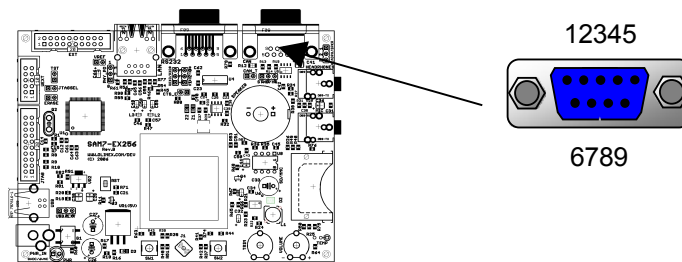

The CAN connector is a standard DB9 male connector.

Note: Don't get confused with the RS232 DB9 female connector!

Table 17 - CAN Connector

Pin #	Signal Name	Pin #	Signal Name
1	NC	6	GND
2	CANL	7	CANH
3	GND	8	CAN Pull-down
4	NC	9	CAN Pull-up
5	NC		

9.8 Microphone Connector

Figure 9-11 - Microphone Connector

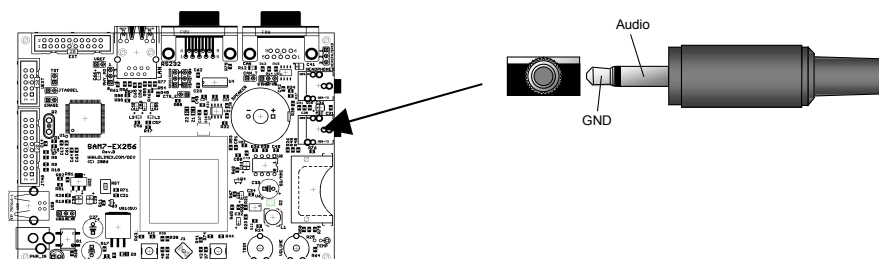

The microphone connector is a standard 3.5mm Jack mono female connector.

9.9 Headphones Connector

Figure 9-12 - Headphone Connector

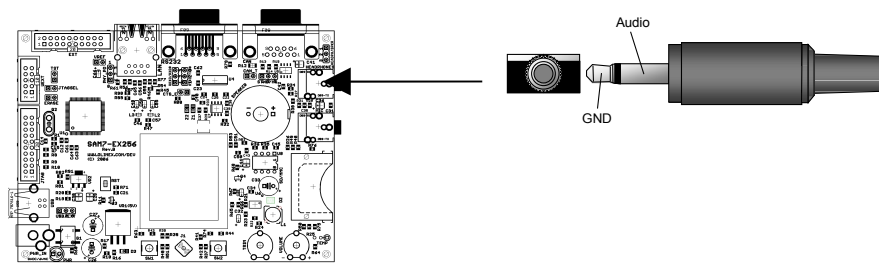

The headphones connector is a standard 3.5mm Jack mono female connector.

9.10 Extension Connectors

9.10.1 EXT Connector

Figure 9-13 - EXT Connector

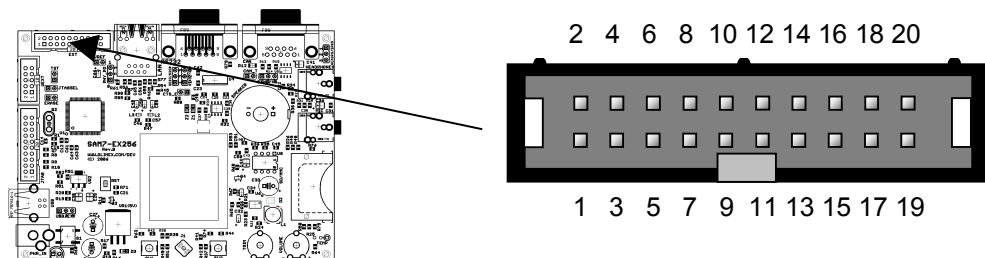

The EXT connector is a 2x10 0.1" pitch 4-Wall header.

Table 18 - EXT Connector

Pin #	Signal Name	Pin #	Signal Name
1	PA3/RTS0	2	PA4/CTS0
3	PA27/DRXD	4	PA28/DTXD
5	PA29/FIQ	6	PA30/IRQ
7	PB18/PHY_PD	8	PB21
9	PB22/WP	10	PB23/CP
11	PB27/AD0	12	PB28/AD1
13	PB29/AD2	14	PB30/AD3
15	AD4	16	VREF
17	+5V	18	3.3V
19	GND	20	RST

9.10.2 UEXT Connector

Figure 9-14 - UEXT Connector

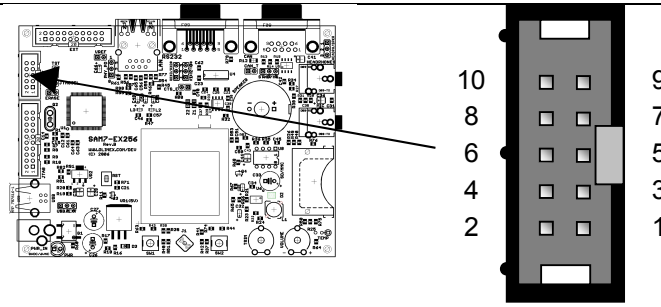

The UEXT connector is a 2x5 0.1" pitch 4-Wall header.

Table 19 - UEXT Connector

Pin #	Signal Name	Pin #	Signal Name
1	3.3V	2	GND
3	TXD1	4	RXD1
5	TWC	6	TWD
7	MISO1	8	MOSI1
9	SCK1	10	SPI1_CS0

9.11 JTAG Connector

Figure 9-15 - JTAG Connector

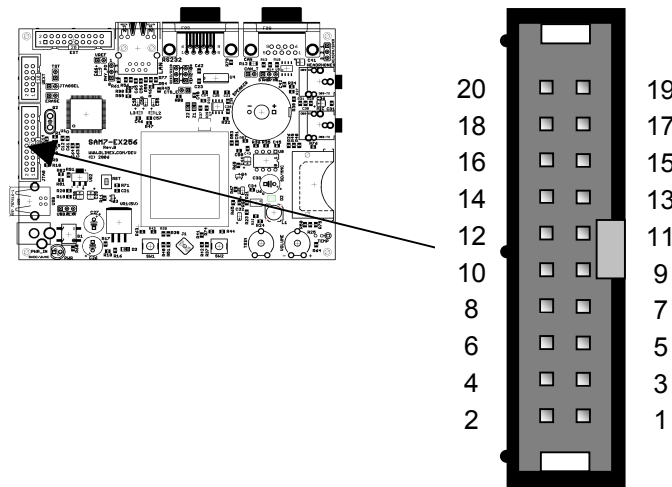

The JTAG connector is a 2x10 0.1" pitch 4-Wall header.

It is compatible with the ARM-JTAG debugging/programming tool.

Table 20 - JTAG Connector

Pin #	Signal Name	Pin #	Signal Name
1	3.3V	2	3.3V
3	TRST	4	GND
5	TDI	6	GND
7	TMS	8	GND
9	TCK	10	GND

11	TCK	12	GND
13	TDO	14	GND
15	RST	16	GND
17	NC	18	GND
19	NC	20	GND

Configuration Straps

This section covers the configuration straps settings.

10.1 Power Configuration

Figure 10-16 – USB/EXT Configuration

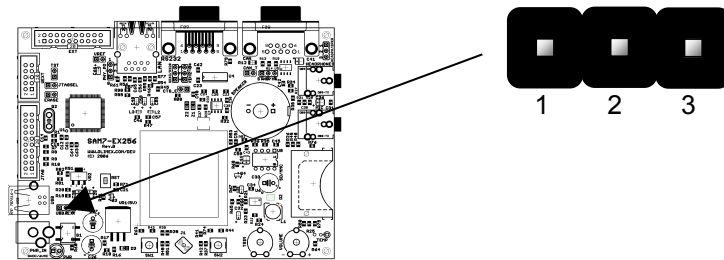

The **USB/EXT** configuration strap enables selecting between USB or external power source:

Table 21 – USB/EXT Configuration Strap

Configuration	Description
1-2	Board is powered from the USB connector
2-3 (Default)	Board is powered from the power connector

10.2 Ethernet Configuration

Figure 10-17 – PHY_PD Configuration

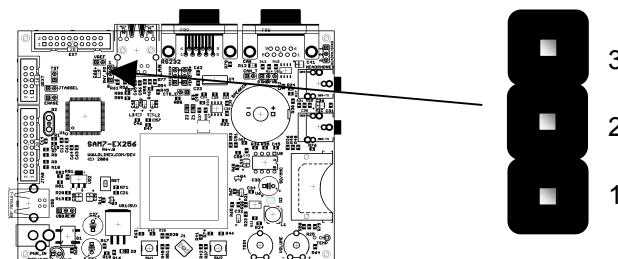

The **PHY_PD** configuration strap enables selecting the Ethernet PHY power down mode:

Table 22 – PHY_PD Configuration Strap

Configuration	Description
Off	Ethernet PHY is powered
1-2 (Default)	Ethernet PHY is powered down
2-3	Ethernet PHY power down is controlled by software

10.3 RS232 Configuration

10.3.1 DRXD/RXD0 Configuration Strap

Figure 10-18 - DRXD/RXD0 Configuration

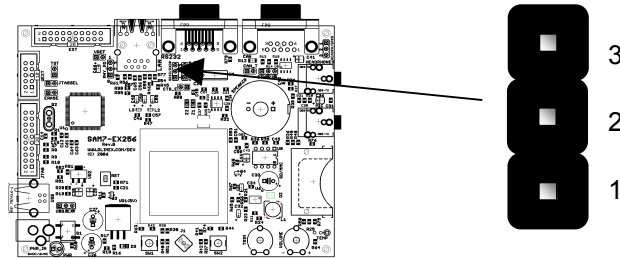

The **DRXD/RXD0** configuration strap enables routing either none, USART0 **RXD0** or debug USART **DRXD** data receive signal to the RS232 buffer and connector:

Table 23 – DRXD/RXD0 Configuration Strap

Configuration	Description
Off	Nothing is routed to RS232 buffer and connector
1-2 (Default)	DRXD is routed to RS232 buffer and connector
2-3	RXD0 is routed to RS232 buffer and connector

10.3.2 DTXD/TXD0 Configuration Strap

Figure 10-19 - DTXD/TXD0 Configuration

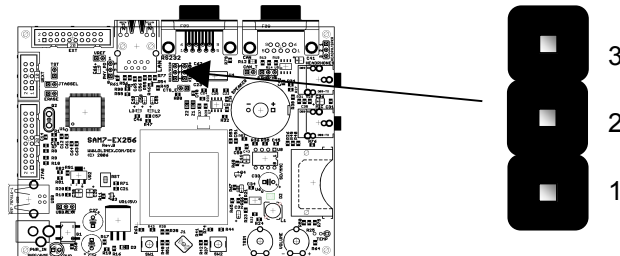

The **DTXD/TXD0** configuration strap enables routing either none, USART0 **TXD0** or debug USART **DTXD** data receive signal to the RS232 buffer and connector:

Table 24 – DTXD/TXD0 Configuration Strap

Configuration	Description
Off	Nothing is routed to RS232 buffer and connector
1-2 (Default)	DTXD is routed to RS232 buffer and connector
2-3	TXD0 is routed to RS232 buffer and connector

10.3.3 CTS_E Configuration Strap

Figure 10-20 - CTS_E Configuration

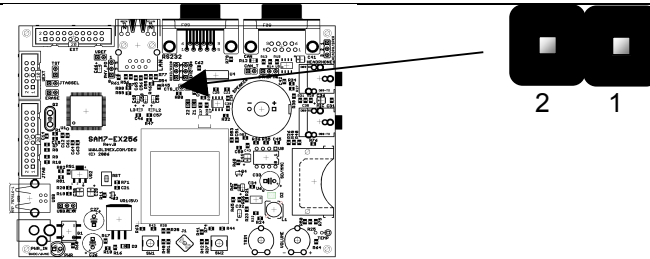

The **CTS_E** configuration strap enables routing USART0 **CTS0** signal to the RS232 buffer and connector:

Table 25 – CTS_E Configuration Strap

Configuration	Description
Off (Default)	CTS0 is not routed
1-2	CTS0 is routed to RS232 buffer and connector

10.4 CAN Configuration

10.4.1 STNB/HS Configuration Strap

Figure 10-21 - STNB/HS Configuration

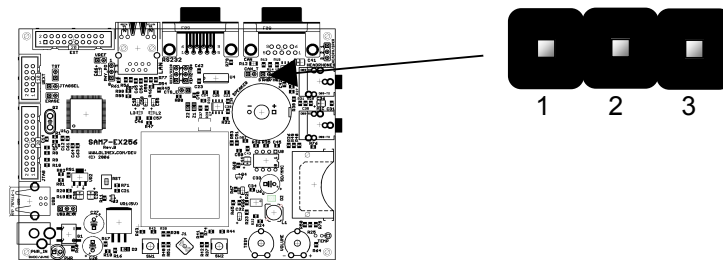

The **STNB/HS** configuration strap enables selecting the CAN transceiver operation mode:

Table 26 - STNB/HS Configuration Strap

Configuration	Description
Off	EMI slope control mode
1-2 (Default)	Standby mode
2-3	High-speed mode

10.4.2 CAN_T Configuration Strap

Figure 10-22 - CAN_T Configuration

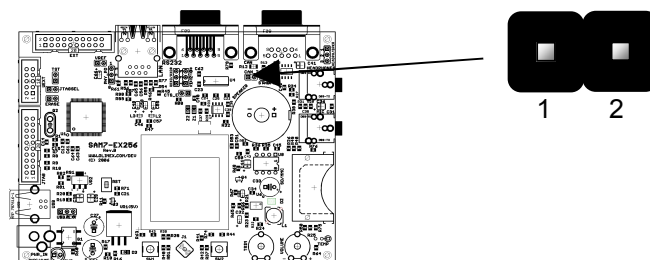

The **CAN_T** configuration strap enables the CAN bus termination by a 120 ohms resistor:

Table 27 - CAN_T Configuration Strap

Configuration	Description
Off	Termination resistor is disabled
1-2 (Default)	Termination resistor is enabled

10.5 Audio Configuration

Figure 10-23 - HEADPH/SPKR Configuration

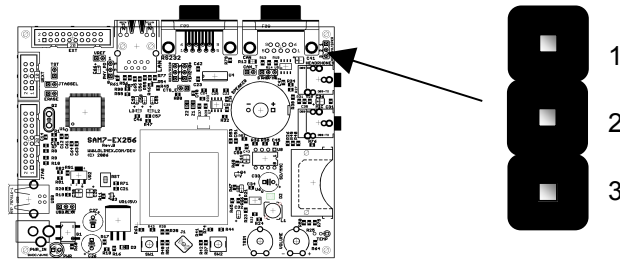

The **HEADPH/SPKR** configuration strap enables selecting between either headphones or speaker audio output:

Table 28 - HEADPH/SPKR Configuration Strap

Configuration	Description
Off	No audio output
1-2 (Default)	Audio output to speaker
2-3	Audio output to headphones jack

10.6 Analog Configuration

Figure 10-24 - VREF Configuration

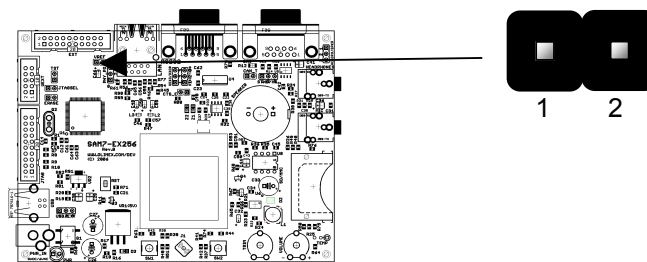

The **VREF** Configuration strap enables setting the analog reference voltage:

Table 29 - VREF Configuration Strap

Configuration	Description
Off	Analog reference voltage is open (a voltage can be fed on pin 1)
1-2 (Default)	Analog reference voltage is 3.3V

10.7 JTAG Configuration

10.7.1 JTAGSEL Configuration Strap

Figure 10-25 - JTAGSEL Configuration

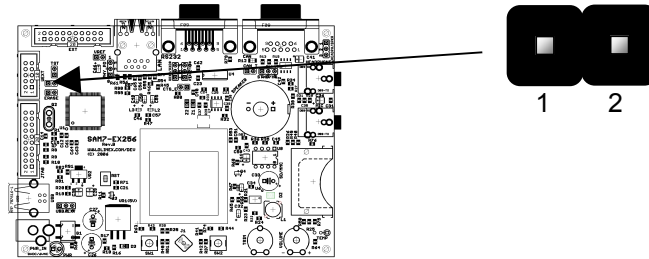

The **JTAGSEL** configuration strap enables JTAG boundary scan/EmbeddedICE™ after RESET:

Table 30 - JTAGSEL Configuration Strap

Configuration	Description
Off (Default)	Enable EmbeddedICE™ after RESET
1-2	Enable JTAG boundary scan after RESET

10.7.2 ERASE Configuration Strap

Figure 10-26 - ERASE Configuration

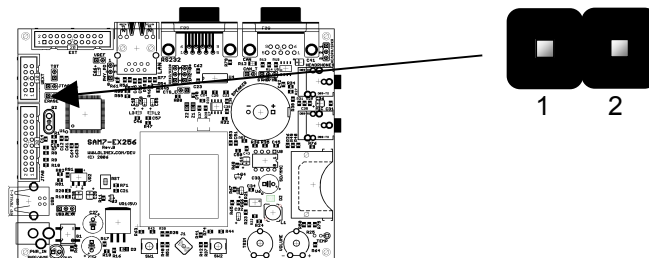

The **ERASE** configuration strap enables reinitializing the Flash content:

Table 31 - ERASE Configuration Strap

Configuration	Description
Off (Default)	Disable Flash initialization
1-2	Reinitialize Flash content

10.7.3 TST Configuration Strap

Figure 10-27 - TST Configuration

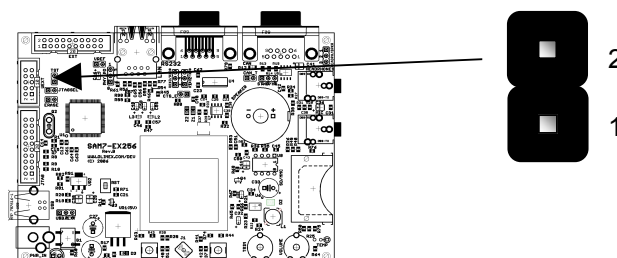

The **TST** configuration strap enables entering in fast (parallel or serial) Flash programming mode:

Table 32 - TST Configuration Strap

Configuration	Description
Off (Default)	Disable fast programming mode
1-2	Enable fast programming mode

Section 11

Memory

This section describes the AT91SAM7X256's memory map.

11.1 Memory

The AT91SAM7X256 contains the following memories:

- 256 Kbytes of Flash Memory
 - 1024 pages of 256 bytes
 - Fast access time, 30 MHz single-cycle access in worst case conditions
 - Page programming time: 6 ms, including page auto-erase
 - Page programming without auto-erase: 3 ms
 - Full chip erase time: 15 ms
 - 10,000 write cycles, 10-year data retention capability
 - 16 lock bits, each protecting 16 sectors of 64 pages
 - Protection Mode to secure contents of the Flash
- 64 Kbytes of Fast SRAM
 - Single-cycle access at full speed
- Unspecified amount of ROM
 - Contains the FFPI and the SAM-BA™ program

11.1.1 Flash Memory

The AT91SAM7X256 features one bank (single plane) of 256 Kbytes of Flash.

At any time, the Flash is mapped to address 0x0010 0000. It is also accessible at address 0x0 after the reset, if GPNVM bit 2 is cleared and before the Remap Command.

A general purpose NVM (GPNVM) bit is used to boot either on the ROM (default) or from the Flash.

This GPNVM bit can be cleared or set respectively through the commands “Clear General-purpose NVM Bit” and “Set General-purpose NVM Bit” of the EFC User Interface.

Setting the GPNVM Bit 2 selects the boot from the Flash. Asserting ERASE clears the GPNVM Bit 2 and thus selects the boot from the ROM by default.

11.1.2 SRAM Memory

The AT91SAM7X256 embeds a high-speed 64 Kbyte SRAM bank.

After reset and until the Remap Command is performed, the SRAM is only accessible at address 0x0020 0000. After Remap, the SRAM also becomes available at address 0x0.

11.1.3 ROM Memory

The AT91SAM7X256 embeds an unspecified amount of Internal ROM. At any time, the ROM is mapped at address 0x30 0000. The ROM contains the FFPI and the SAM-BA™ program. A general purpose NVM (GPNVM) bit is used to boot either on the ROM (default) or from the Flash.

This GPNVM bit can be cleared or set respectively through the commands “Clear General-purpose NVM Bit” and “Set General-purpose NVM Bit” of the EFC User Interface.

Setting the GPNVM Bit 2 selects the boot from the Flash. Asserting ERASE clears the GPNVM Bit 2 and thus selects the boot from the ROM by default.

Figure 11-28 - Memory Map

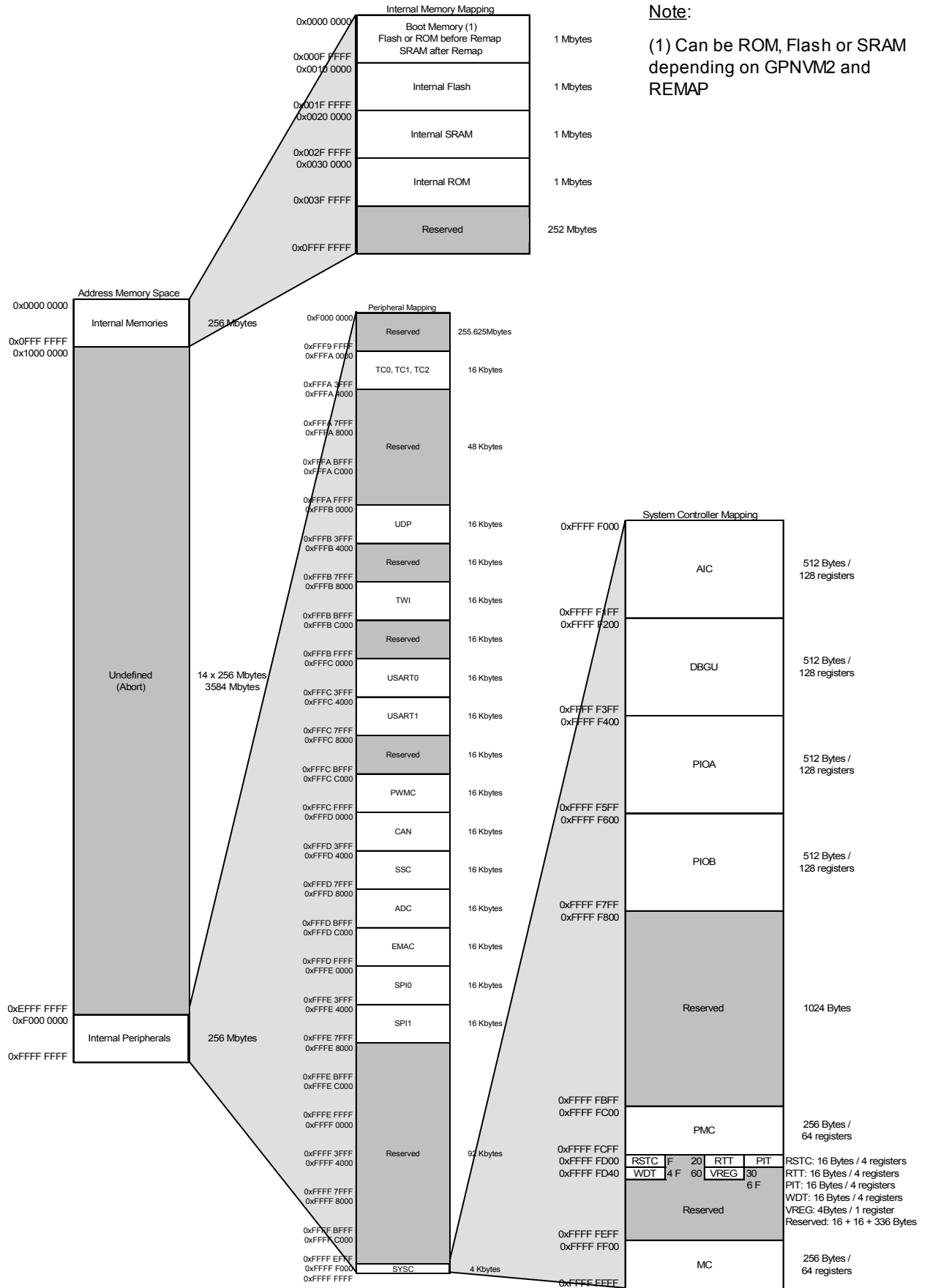

Note:

(1) Can be ROM, Flash or SRAM depending on GPNVM2 and REMAP

Section 12

Schematics

12.1 Schematics

Figure 12-29. Schematics

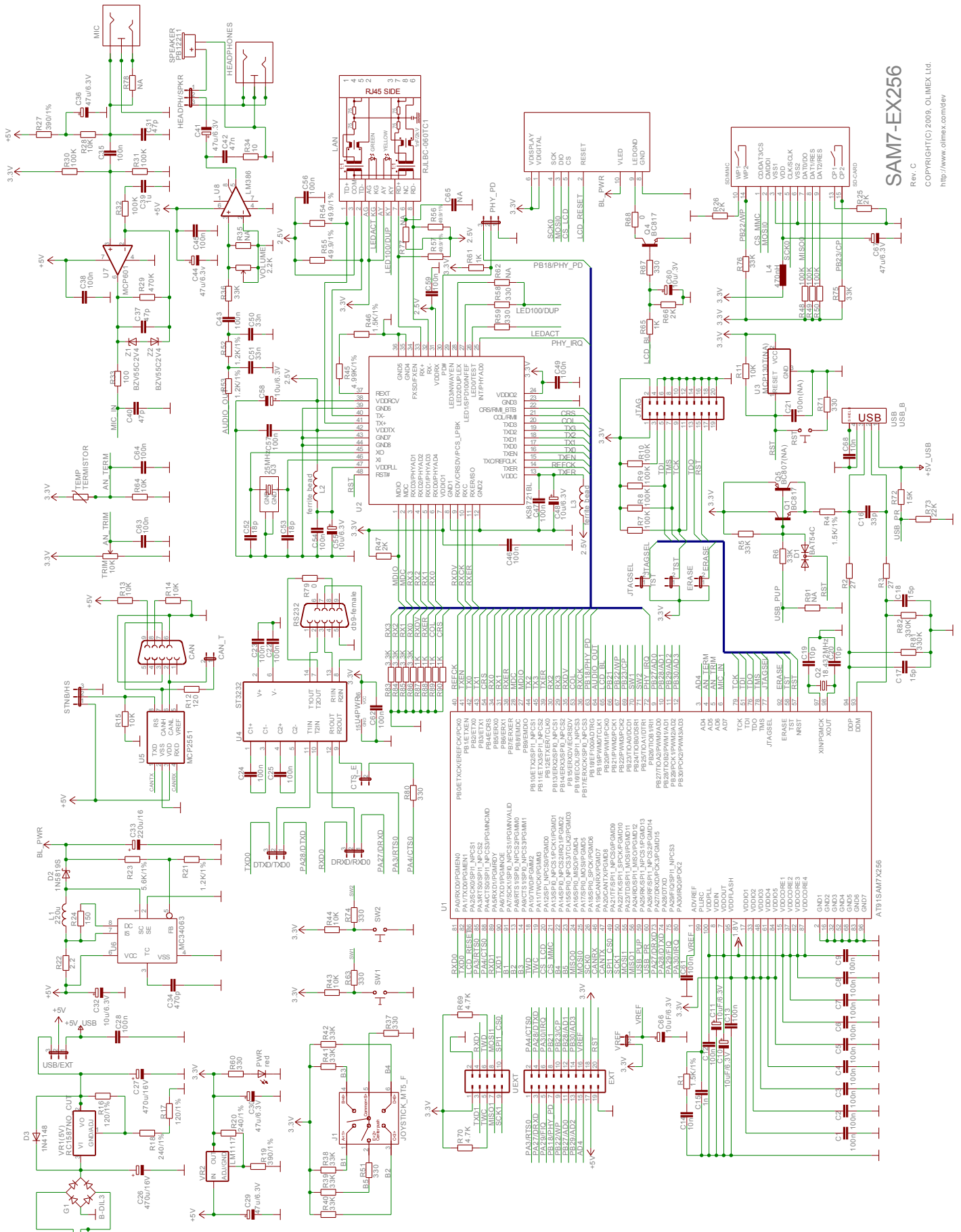

13.1 Mechanical Dimensions

Figure 13-30. Mechanical Drawing

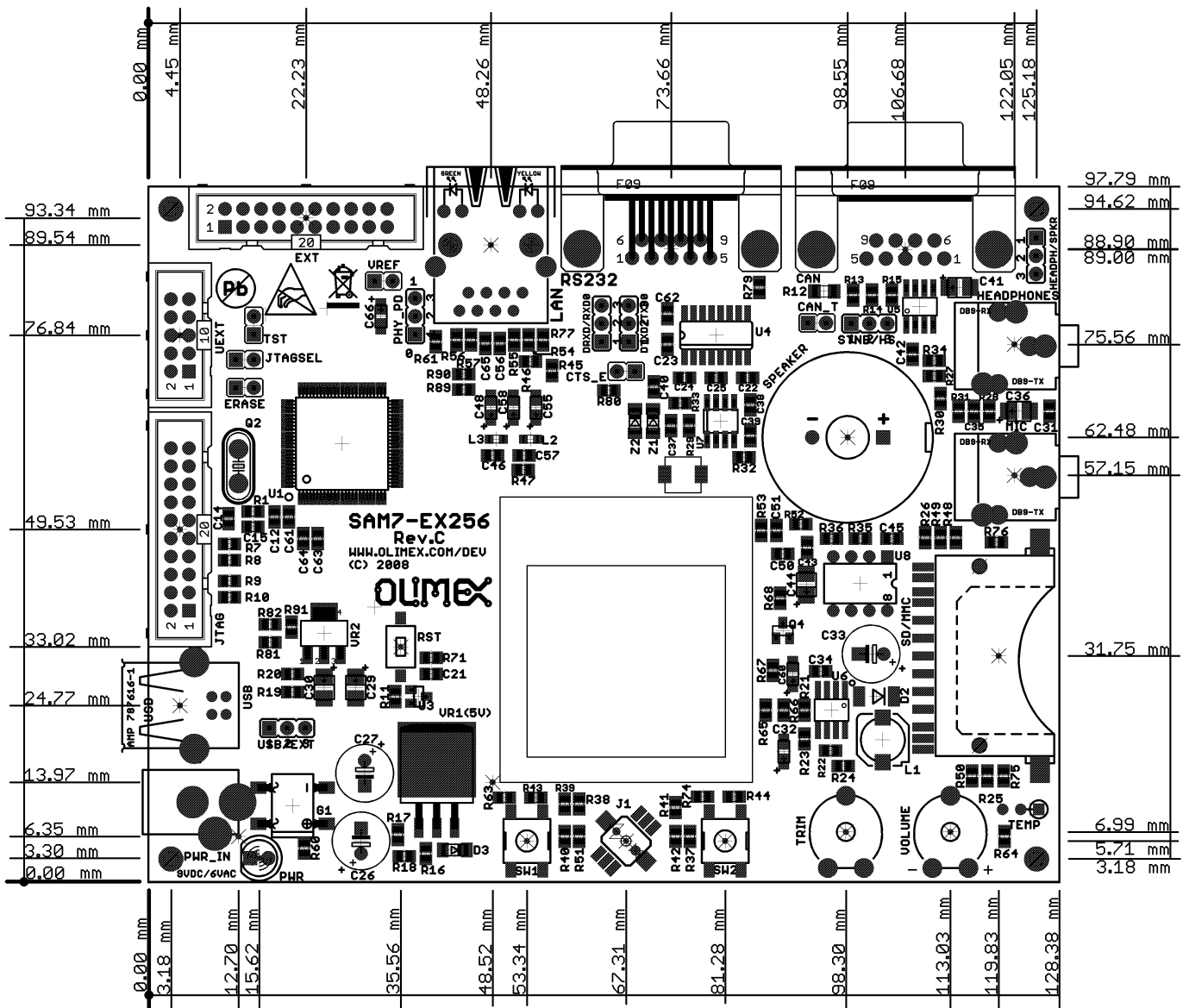

A	
ADC.....	1, 2, 3, 5, 6
Advanced Encryption System.....	2
Advanced Interrupt Controller.....	2
AES.....	2
AIC.....	2
7.10Analog Inputs.....	6
Configuration.....	4
Examples.....	6
Microphone.....	5
Thermistor.....	6
VREF Selection.....	4, 6
ARM-JTAG.....	1, 2, 6
ARM-USB_OCD.....	1
ARM-USB-TINY.....	1
7.8Audio.....	5
Bus.....	3
Configuration.....	4
Connector.....	4, 5
Examples.....	5
Headphone/Speaker Selection.....	6
Headphones.....	2, 5
In 2	
Microphone.....	2, 5, 6
Out.....	2, 5
Speaker.....	2, 5, 6
Volume Control.....	2, 6
B	
Block Diagram.....	1, 4
Busses.....	
Bus A.....	4
Bus B.....	5
Communication.....	1
I2C™.....	2
MII.....	1
Peripheral.....	3
Serial Synchronous.....	3
SPI.....	2
TWI.....	2
Buttons.....	2
C	
7.7CAN.....	1, 5
Configuration.....	3
Connector.....	4, 5
Controller.....	2, 5
Receive.....	4
Standby/HS Selection.....	5
STNB/HS Configuration.....	3
Termination Selection.....	3, 5
Transceiver.....	3, 5
Transmit.....	4
CKGR.....	1
Clock.....	
Circuitry.....	2, 3

Index	Section 14
Crystal.....	2
Generator.....	1
JTAG.....	2
Configuration Straps.....	1
Connectors.....	1
CAN.....	4, 5
Ethernet.....	2, 3
EXT.....	2, 4, 5, 6
Headphones.....	5
JTAG.....	1, 6
LCD.....	1
Microphone.....	4
Power Supply.....	1
RS232.....	3, 5
SD/MMC Card.....	2, 3
UEXT.....	2, 3, 5, 6
USB.....	1, 2
Control Circuitry.....	1
Crystal.....	1, 2, 3
D	
DBGU.....	1, 2, 4
Debug.....	2
Configuration.....	2
Interface.....	1, 2, 4
Unit.....	2
Dimensions.....	1, 2
DMA.....	1, 2
E	
Electrostatic Discharge.....	1
EmbeddedICE™.....	1, 5
ESD.....	1
7.4 Ethernet.....	1, 3
Clock.....	1, 5
Configuration.....	1
Connector.....	2
Crystal.....	1, 2, 3
Examples.....	3
Interrupt.....	6
LEDs.....	2, 3
MAC.....	2
PHY.....	1, 2, 3, 6
Power Down.....	1, 3, 5
Examples.....	6
Analog Inputs.....	5
Audio.....	3
Ethernet.....	1
LCD Screen.....	5
RS232.....	3
SD/MMC Card.....	6
Thermistor.....	3
USB.....	2
User Inputs.....	5
Extension Connectors.....	5
F	
Flash Memory.....	1
G	
General Purpose Input/Output.....	3
GPIO.....	1, 3, 4, 5
H	
Headphones.....	2
I	
I2C™.....	1, 2, 3, 4
Clock.....	4

Master Mode.....	2
I ² S.....	2
ICE.....	1
Interrupts.....	2, 5, 6
IrDA®.....	2, 4
J	
Joystick.....	2
8.1.2JTAG.....	1, 2, 3
Configuration.....	1, 2, 5
Connector.....	1, 6
Interface.....	1
Jumpers.....	
CAN_T.....	5
CTS_E.....	3, 5
DRXD/RXD0.....	2, 5
DTXD/TXD0.....	2, 5
ERASE.....	2, 5
HEADPH/SPKR.....	4, 6
JTAGSEL.....	1, 2, 5
PHY_PD.....	1, 3
STDB/HS.....	5
TST.....	2, 6
USB/EXT.....	1, 3
VREF.....	6
L	
Layout.....	3
7.1LCD Screen.....	1, 2
Backlight.....	1, 2, 5
Characteristics.....	1
Chip Select.....	4
Connector.....	1
Examples.....	1
Reset.....	1, 4
Types.....	1
LED.....	
Ethernet.....	2
Power Supply.....	1, 2
Supply Voltage.....	2
M	
MC.....	1
Mechanical Drawings.....	1
Media Independent Interface.....	2
Memory.....	
Controller.....	1
Erase.....	2, 5
Flash.....	1, 2, 6
Map.....	1
RAM.....	1
ROM.....	1
Microcontroller.....	1, 2
MII.....	1, 2
P	
Package.....	1, 3
Parallel Input/Output Controllers.....	2
PCB.....	2
PDC.....	1, 2
Periodic Interval Timer.....	2
Peripheral DMA Controller.....	1
Peripherals.....	1
Phase-Locked Loop.....	2
PIO.....	2, 3
PIT.....	2
PLL.....	2
PMC.....	2
Power Management Controller.....	2
5.1Power Supply.....	1, 2, 3
Adapter.....	1, 2

Configuration.....	1
Connector.....	1
LCD Backlight.....	2
Selection.....	1
USB.....	1, 2
Voltage Regulator.....	1, 2, 3, 4
Pulse Width Modulation Controller.....	3
PWM.....	1, 2, 5
PWMC.....	3
R	
RAM.....	1
Real-time Timer.....	2
Reduced Media Independent Interface.....	2
Requirements.....	1
Reset.....	
Circuitry.....	1, 2
Controller.....	1
Switch.....	2
RMII.....	2, 3
ROM.....	1
7.6RS232.....	2, 4
Configuration.....	2
Connector.....	3, 5
Examples.....	5
IrDA®.....	4
RX/TX/CTS Selection.....	5
Transceiver.....	5
RS485.....	3, 4
RSTC.....	1
RTT.....	1, 2
S	
SAM-BA™.....	1, 2, 3, 4
Schematics.....	1
7.3SD/MMC Card.....	1, 2
Chip Select.....	2, 4
Connector.....	2, 3
Examples.....	3
Present.....	2, 3, 6
Write Protect.....	2, 3, 5
Serial Peripheral Interface.....	3
Serial Synchronous.....	3
Serial Synchronous Controller.....	3
Signals.....	
AD[0..7].....	5, 6
ADTRG.....	5
AN_TERM.....	6
AUDIO_OUT.....	5
B[1..5].....	2, 4
CAN Pull-down.....	4
CAN Pull-up.....	4
CANH.....	4
CANL.....	4
CANRX.....	4
CANTX.....	4
COL.....	5
CP.....	3
CP_PD.....	3
CRS.....	5
CS_LCD.....	1, 2, 4
CS_MMC.....	2, 3, 4
CTS.....	4, 5
CTS0.....	3, 4, 5
CTS1.....	4, 5
DCD1.....	4, 5, 6
DDM.....	3
DDP.....	2
DRXD.....	2, 4, 5
DSR1.....	4, 5, 6

DTR1.....	4, 5, 6
DTXD.....	2, 5
DXRD.....	2
ECOL.....	5
ECRS.....	5
EF100.....	5
EMDC.....	5
EMDIO.....	5
ERX[0..3].....	5
ERXCK.....	5
ERXDV/ECRSDV.....	5
ERXER.....	5
ETX[0..3].....	5
ETXCK/EREFCK.....	5
ETXEN.....	5
ETXER.....	5
FIQ.....	5
GND.....	1, 2, 3, 4, 5, 6, 7
IRQ[0..1].....	4, 5
LCD_BL.....	1, 2, 5
LCD_RESET.....	1, 4
LEDGND.....	2
MDC.....	1, 5
MDIO.....	1, 5
MISO0.....	1, 2, 3, 4
MISO1.....	2, 3, 4, 6
MOSI0.....	1, 2, 3, 4
MOSI1.....	2, 3, 4, 6
Non Routed.....	3
nRESET.....	1
PA27/DRXD.....	4
PA28/DTXD.....	5
PA29/FIQ.....	5
PA3/RTS0.....	4
PA30/IRQ.....	5
PA4/CTS0.....	4
PB18/PHY_PD.....	3, 5
PB21.....	5
PB22.....	3
PB22/WP.....	2, 5
PB23.....	3
PB23/CP.....	2, 5, 6
PB27/AD0.....	5, 6
PB28/AD1.....	5, 6
PB29/AD2.....	5, 6
PB30/AD3.....	5, 6
PCK[0..3].....	2, 4, 5, 6
PHY_IRQ.....	6
PWM[0..3].....	2, 5, 6
RD.....	3, 4
REF.....	4
REFCK.....	1, 5
RESET.....	2
RF.....	3, 4
RI1.....	4, 5, 6
RK.....	3, 4
RST.....	4, 5, 7
RTCK.....	2
RTS.....	4
RTS0.....	4, 5
RTS1.....	4, 5
RX.....	2
RX[0..3].....	5
RX+.....	2
RXCK.....	1, 5
RxD.....	4
RXD[0..3].....	1
RXD0.....	2, 4
RXD1.....	4, 5, 6
RXDV.....	1, 5
RXER.....	1, 5
SCK.....	2

Index	Section 14
SCK0.....	1, 2, 3, 4
SCK1.....	2, 3, 4, 6
SP1_NPCS[0..3].....	5
SPI0_NPCS[0..3].....	4, 5
SPI1_CS[0..2].....	6
SPI1_CS0.....	2, 3, 4
SPI1_MISO.....	4
SPI1_MOSI.....	4
SPI1_NPCS[0..3].....	4, 5
SPI1_SPCK.....	4
SPIO_SPCK.....	4
SPIO0_MISO.....	4
SPIO0_MOSI.....	4
SPIO0_NPCS[0..3].....	4, 5
SW[1..2].....	2, 6
TCK.....	2, 7
TCLK[0..2].....	4, 5
TD.....	3, 4
TDI.....	1, 4, 6
TDO.....	2, 4, 7
TF.....	3, 4
TIO[A..B][0..2].....	6
TK.....	3, 4
TMS.....	1, 7
TRST.....	6
TWC.....	3, 4, 6
TWCK.....	4
TWD.....	3, 4, 6
TX-.....	2
TX[0..3].....	1, 5
TX+.....	2
TXD.....	4
TXD0.....	2, 4
TXD1.....	4, 5, 6
TXEN.....	1, 5
TXER.....	1, 5
TXRD.....	2
USB_PR.....	4
USB_PUP.....	4
VLCD.....	2
VREF.....	4, 5, 6
WP.....	3
WP_PU.....	3
+5V_USB.....	2
Smart Card.....	3, 4
Speaker.....	2
SPI.....	1, 2, 3, 4
Clock.....	1, 2, 4
SRAM.....	1
SS Clock.....	3
SSC.....	1, 2, 3
Switches.....	6
Synchronous Serial Controller.....	1, 2
SYSC.....	3
T	
TC.....	3
Temperature Sensor.....	6
Thermistor.....	2, 6
Thermistor.....	6
Examples.....	6
Timer/Counter.....	3
Toolchain.....	1
Trim potentiometer.....	2
TWI.....	1
Two-wire Interface.....	3
U	
UART.....	1
Universal Synchronous/Asynchronous Receiver Transmitter.....	2

USART.....	2, 4
7.5USB.....	1, 2, 3, 4
Cable.....	1, 2, 4
Connector.....	2, 3
Disconnect.....	4
Examples.....	3
Power Supply.....	1, 2
Present.....	4
7.2User Inputs.....	2
Examples.....	2
Joystick.....	2, 4
Left.....	2, 6
Reset.....	1
Right.....	2, 6
Switches.....	2
Trim Potentiometer.....	2, 6
Volume Potentiometer.....	6
V	
Voltage Regulator.....	2
Volume Control.....	2
W	
Watchdog.....	1
WDT.....	1, 2

Revision History

Revision	Changes
A	Initial Creation
B	Explicit RS232 availability, added CAN & UEXT in the list Made tool links visible Corrected reference to gate rectifier G1, marked Reset IC as not mounted Swapped R58 & R62 Corrected LM386 name Changed Ethernet connector table Renamed Table 31
C	Added 10n to USB shield Added some signs like Pb, ESD R47 changed from 2.2K to 2K R5 and R6 changed from 47K to 33K R27 changed from 470n/5% to 390n/1% Q4 changed from BC847 to BC817 R22 changed from 2.2 Ohm to 1 Ohm R52 and R53 changed from 1.2K/5% to 1.2K/1% R1 and R4 changed from 1.5K/5% to 1.5K/1%



OLIMEX Ltd.

89 Slavjanska St.,
P.O.Box 237, Plovdiv 4000, Bulgaria
Tel: +359-32-626259
Fax: +359-32-621270
Email: info@olimex.com
Contact: Mr. Tsvetan Usunov

Distributors

Australia

Dontronics
Website: [Dontronics](http://www.dontronics.com)

Austria

Megaton Handelsgesellschaft m. b. H.
Franz Schubertgasse 12A
A-2372 Gießhübl, Austria
Tel: +43 2236 / 43179
Fax: +43 2236 / 43179-21
Email: office@megaton.at
Website: <http://www.megaton.at>

Belgium

Antratek Electronics Belgium
Cipalstraat 3, 2440 Geel, Belgium
Tel: +32 014 570557
Fax: +32 014 570556
Email: info@antratek.be
Website: <http://www.antratek.nl>

Bulgaria

Comet Electronics
16 Tsar Samuil Str.
Sofia 1000, Bulgaria
Call center Tel: +359 2 915 58 55
Call center Fax: +359 2 954 03 84
Office Tel: +359 2 915 58 00
Email: office@comet.bg
Website: <http://home.comet.bg>
Canada

Optimal Microsystems
Website: <http://optimal-microsystems.com>

Chile & South America

Ingeniería MCI Ltda.
Tel: +56 2 3339579
Fax: +56 2 3350589
Email: info@olimex.cl
Website: <http://www.olimex.cl>

Denmark

Demotech
Hækvej 3, Viftrup
DK-7540 Haderup, Denmark
Contact: Jan Hynneke
Email: sales@demotech.dk
Website: <http://www.demotech.dk>

Finland

Atomia Oy
Koskitie 33 b 17
90500 Oulu, Finland
Tel: +358 44 0212838
Email: etunimi.sukunimi@atomia.net
Website: <http://www.atomia.net>

France

Lextronic
36/40 Rue du Gal de Gaulle
94510 La Queue en Brie, France
Tel: +33 1 45 76 83 88
Fax: +33 1 45 76 81 41
Email: info@lextronic.fr
Website: <http://www.lextronic.fr>

Germany

Elektronikladen Mikrocomputer
Giesler & Danne GmbH & Co. KG
Wilhelm-Mellies-Str. 88,
32758 Detmold, Germany
Tel.: +49 05232-8171
Fax: +49 05232-86197
Email:
elektronikladen@elektronikladen.de
Website: <http://elmicro.com>

Hong Kong

TechToys Company
Unit 1805, 18/F.,

Pacific Plaza,
410 Des Voeux Road West,
Hong Kong
Tel: +852 28576267
Fax: +852 28576216
Email: john@TechToys.com.hk
Contact: John Leung
Website: <http://www.techtoys.com.hk>

Hungary

KoPoG Kereskedelmi és Szolgáltató Bt.
Bem utca 31. 3.em.7.
Budapest, Magyarország 1193
Tel: +36 01-06-740146
Fax: +36 20964917-3-43
Email: monosx@monosx.org
Website: <http://www.monosx.hu>

India

Logsun Systems
Regd office – B2, Raunak,
134/4+3B, Kothrud,
Near Mayur Colony,
Pune: 411 038 linda
Tel: +91 - 20 - 32937840,
2541 0129, 25446815
Fax: +91 - 20 - 2541 0129
Email: logsun@eth.net
Website: www.logsun.com

Israel

BZ-COM Ltd
Tel: +972-8-8523548
Fax: +972-8-8565825
Email: info@bz-com.com
Website: <http://www.bz-com.com>

Italy

Robot Italy
DROIDS SAS
di Carnevale Luigi & C.
Via Nannarelli, 41
00139 – Roma, Italy
Fax: +39-06.233.243.440
Website: <http://www.robot-italy.com>

Artek Electronic Solutions S.n.c
Via E. Malatesta, 16
40026 Imola (BO), Italy
Tel: +39 0542 643192
Fax: +39 0542 688405
Email: artek@artek.it
Website: <http://www.artek.it>

Korea

KitKorea
Tel: +82 031-429-0845
Fax: +82 031-477-1407
Email: open@kitkorea.com
Website: <http://www.kitkorea.com>

Mexico

AG Electrónica S.A. de C.V.
Rep. del Salvador #20 Piso 2
México D.F. C.P. 06000, Mexico
Email:
ventasag@agelectronica.com.mx
Website:
<http://www.agelectronica.com>

Netherlands

Van Ooijen Technische Infomatica
Utrechtseweg 173, 3818 ED
Amersfoort, Netherlands
Tel: +31 33 4621296, +31 6
44286985
Fax: +31 84 741 5448
Email: wouter@voti.nl
Website: www.voti.nl

Antratek Electronics
ApolloWeg 206, 8239 DB Lelystad,
Netherlands
Tel: +31 0320 258 334

Fax: +31 0320 258 019
Email: info@antratek.nl
Website: <http://www.antratek.nl>

Norway

Livermore Consulting AS
Mårstien 14
N-3188 Horten, Norway
Tel: +47 93 43 92 70
Email: info@livermore.no
Website: <http://www.livermore.no>

Philippines

MicroController Pros Corporation
17408 Blue Jay Drive
Morgan Hill, CA 95037, USA
Tel: +1 408 333 9266
Fax: +1 215 243 6071
Website:
<http://microcontrollershop.com>

Poland

Kristech Krzysztof Kajstura
ul. Porzeczkowa 12
43-450 Ustron, Poland
Fax: +48 33 487 69 45
Email: support@kristech.eu
Website: <http://www.kristech.pl>

Portugal

GoldTronica
Rua Gil Vicente 26, 212
2660-163 Loures – Portugal
Tel: +351 967841810
Fax: +351 219827738
Website: <http://shop.gtronica.com>

Romania

Comet Electronics s.r.l.
Str. Grigore Ionescu No 94, Bloc
T7B, Parter, Sector 2
Bucharest, Romania
Tel: +40 21 243 20 90
Fax: +40 21 243 40 90
Email: office@comet.srl.ro
Website: <http://www.comet.srl.ro>

Russia & C.I.S.

TerraElectronica
Москва, ул. Дербеневская 1/2,
корпус 1, подъезд 23
Tel: +495 221-78-04
Fax: +495 221-78-02
Email: sale@terraelectronica.ru
Website:
<http://www.terraelectronica.ru>

MT-Systems
198099, Россия, Санкт-Петербург,
ул. Калинина д. 13
Tel: +7 (812) 325-36-85
Fax: +7 (812) 786-85-79
Email: micro@mtgroup.ru
Website: <http://www.mt-system.ru>

Serbia & Montenegro

Comet Electronics d.o.o
Bulevar Arsenija Čarnojevića
broj 17
11070 Novi Beograd
Tel: +381 011 / 3113942
Fax: +381 2134180
Email: office@comet.co.yu
Website: <http://www.comet.co.yu>

Spain

Contact our Portugal re-seller
Gtronica.Lda

Sweden

Lawicel
Tel: +46 451 59877
Fax: +46 451 59878
Website: <http://www.lawicel-shop.se>

Switzerland

Bernhard Elektronik
Aarauer Str. 20, CH-5734 Reinach,
Switzerland
Tel: +41-(0)62-7716944

Taiwan

Intelligent Control Systems
Tel: +886 (02) 2378-7672
Fax: +886 (02) 2378-7627
Email: sales@ict.com.tw
Website: <http://www.ict.com.tw>

UK

Cool Components
Website:
<http://www.coolcomponents.co.uk>

USA

Spark Fun Electronics
2500 Central Ave.
Suite Q
Boulder, CO 80301, USA
Tel: +1 303-284-0979
Email: fun@sparkfun.com
Website: <http://www.sparkfun.com>

MicroController Pros Corporation
17408 Blue Jay Drive
Morgan Hill, CA 95037, USA
Tel: +1 408 333 9266
Fax: +1 215 243 6071
Website:
<http://microcontrollershop.com>