

# STM32F103C8 - Tomatenbewässerung

## Board-Connector

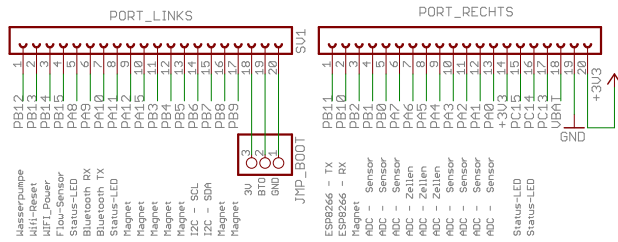

## Spannungsversorgung

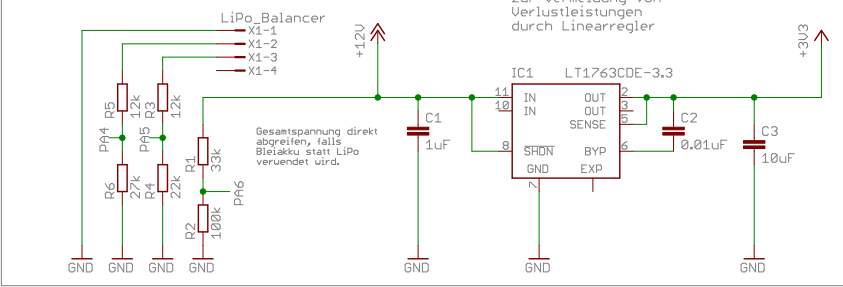

## Bluetooth HC-05

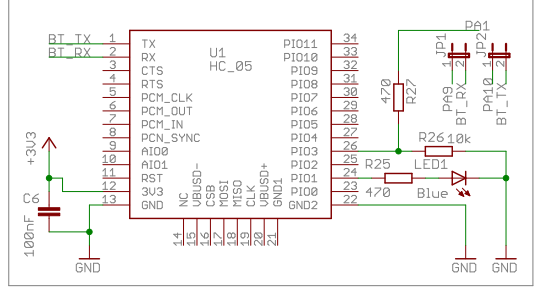

## 12V - Wasserpumpe

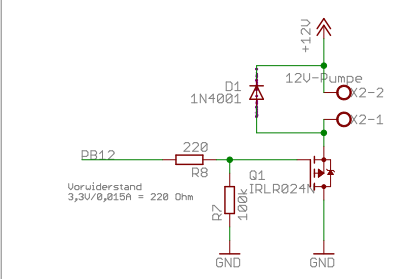

## Magnetschalter - 12V - 8x

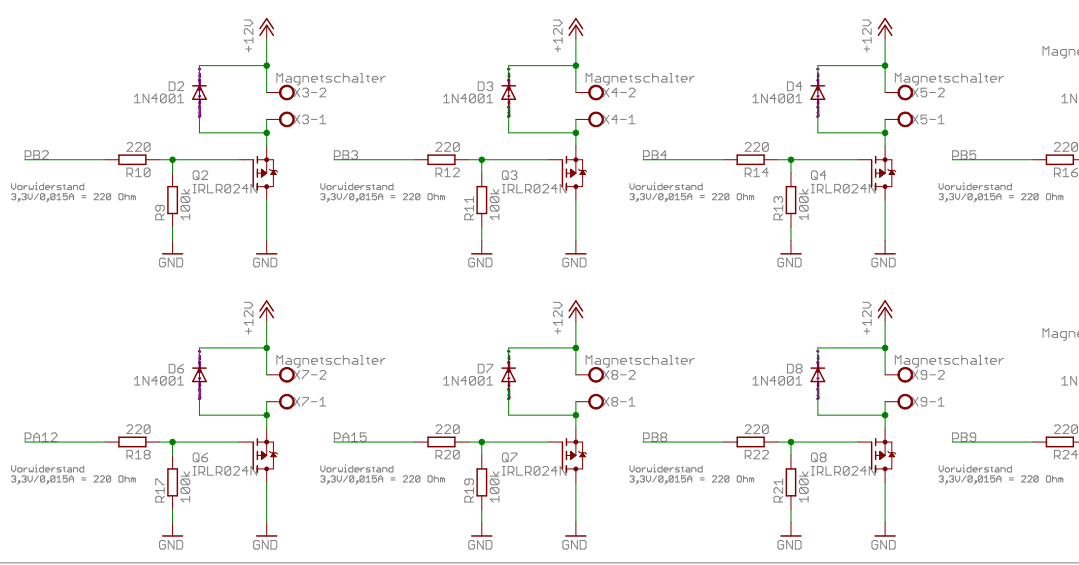

## Sensoren - 7x

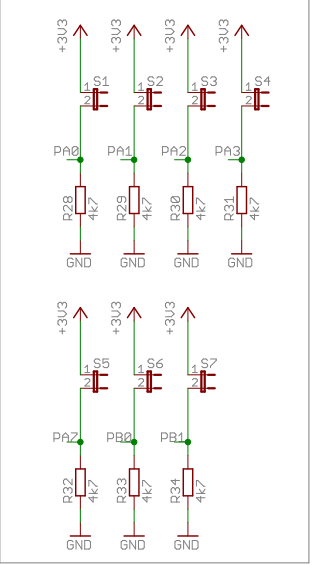

## ESP8266-12

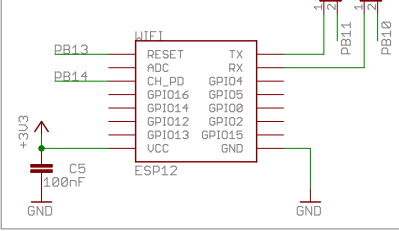

## Flow-Sensor TE238

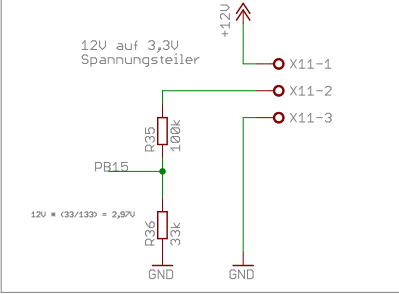

## I<sup>2</sup>C-Bus

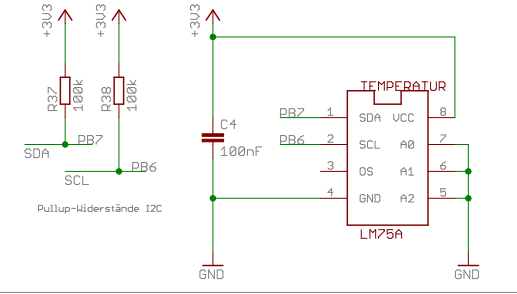

## Status-LEDs

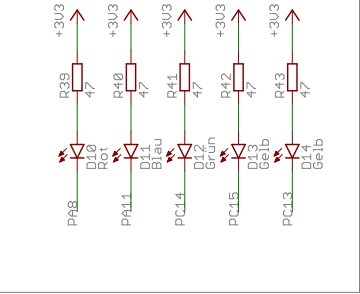

TITLE: STM32_Tomaten	
Document Number:	REV:
Date: 12.05.2016 21:14:01	Sheet: 1/1