

# STM32F103C8 - Tomatenbewässerung

## Board-Connector

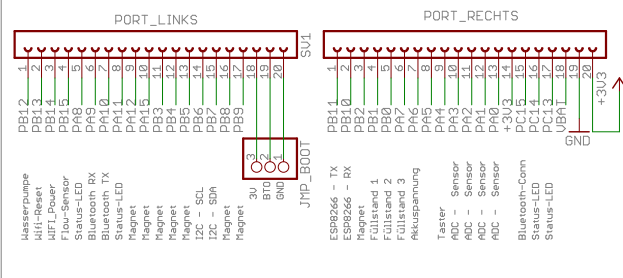

## Spannungsversorgung

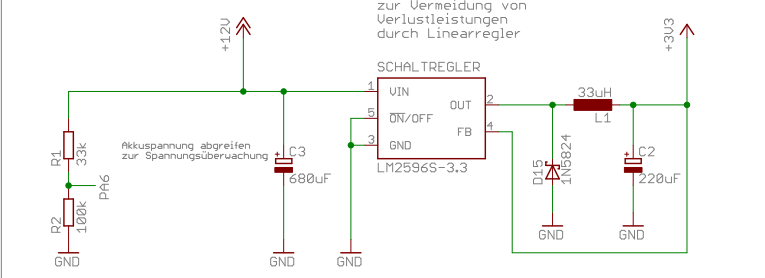

## Bluetooth HC-05

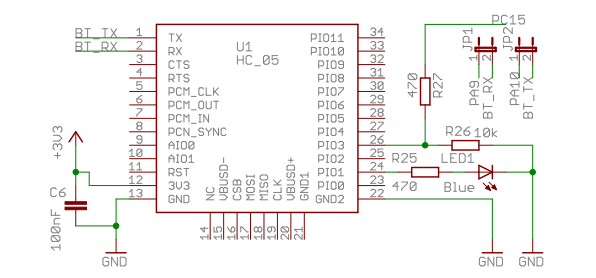

## 12V - Wasserpumpe

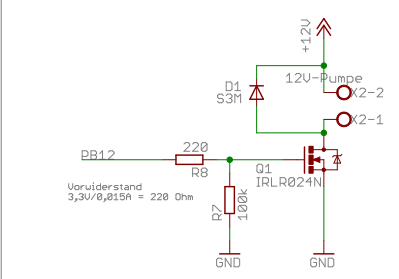

## Magnetschalter - 12V - 8x

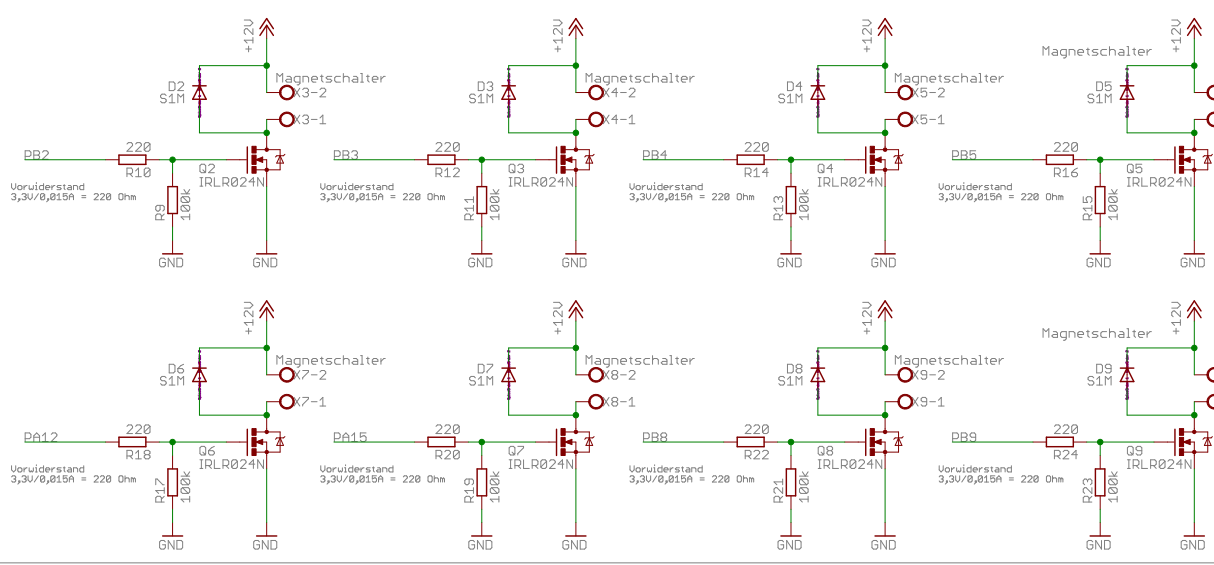

## Sensoren - 4x

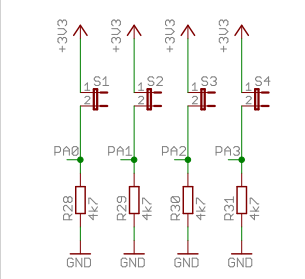

## ESP8266-12

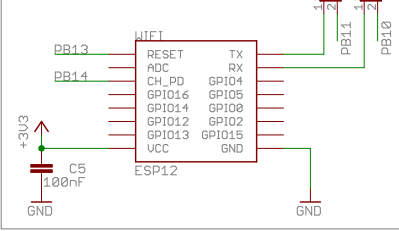

## Füllstand

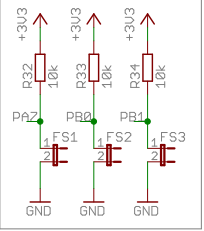

## Taster

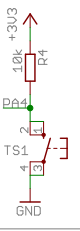

## Flow-Sensor TE238

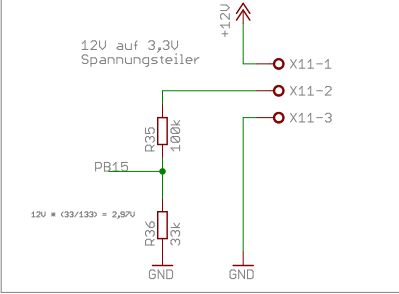

## I<sup>2</sup>C-Bus

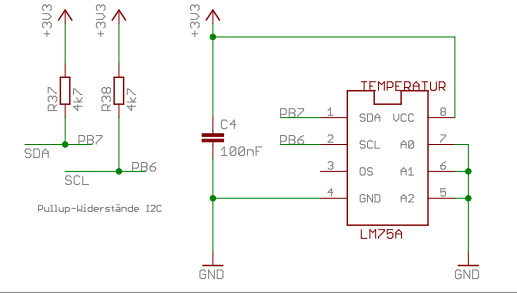

## Status-LEDs

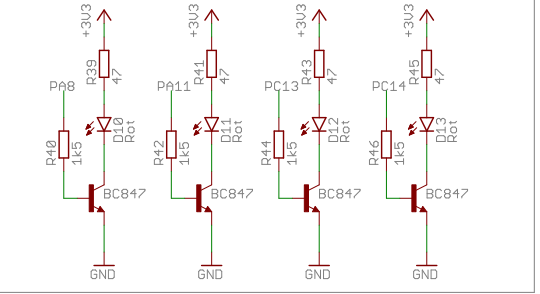

## Power-Port

