

**M4A77D**

**ASUS**<sup>®</sup>

**Motherboard**

E5148

Second Edition V2

October 2009

**Copyright © 2009 ASUSTeK Computer Inc. All Rights Reserved.**

No part of this manual, including the products and software described in it, may be reproduced, transmitted, transcribed, stored in a retrieval system, or translated into any language in any form or by any means, except documentation kept by the purchaser for backup purposes, without the express written permission of ASUSTeK Computer Inc. ("ASUS").

Product warranty or service will not be extended if: (1) the product is repaired, modified or altered, unless such repair, modification or alteration is authorized in writing by ASUS; or (2) the serial number of the product is defaced or missing.

ASUS PROVIDES THIS MANUAL "AS IS" WITHOUT WARRANTY OF ANY KIND, EITHER EXPRESS OR IMPLIED, INCLUDING BUT NOT LIMITED TO THE IMPLIED WARRANTIES OR CONDITIONS OF MERCHANTABILITY OR FITNESS FOR A PARTICULAR PURPOSE. IN NO EVENT SHALL ASUS, ITS DIRECTORS, OFFICERS, EMPLOYEES OR AGENTS BE LIABLE FOR ANY INDIRECT, SPECIAL, INCIDENTAL, OR CONSEQUENTIAL DAMAGES (INCLUDING DAMAGES FOR LOSS OF PROFITS, LOSS OF BUSINESS, LOSS OF USE OR DATA, INTERRUPTION OF BUSINESS AND THE LIKE), EVEN IF ASUS HAS BEEN ADVISED OF THE POSSIBILITY OF SUCH DAMAGES ARISING FROM ANY DEFECT OR ERROR IN THIS MANUAL OR PRODUCT.

SPECIFICATIONS AND INFORMATION CONTAINED IN THIS MANUAL ARE FURNISHED FOR INFORMATIONAL USE ONLY, AND ARE SUBJECT TO CHANGE AT ANY TIME WITHOUT NOTICE, AND SHOULD NOT BE CONSTRUED AS A COMMITMENT BY ASUS. ASUS ASSUMES NO RESPONSIBILITY OR LIABILITY FOR ANY ERRORS OR INACCURACIES THAT MAY APPEAR IN THIS MANUAL, INCLUDING THE PRODUCTS AND SOFTWARE DESCRIBED IN IT.

Products and corporate names appearing in this manual may or may not be registered trademarks or copyrights of their respective companies, and are used only for identification or explanation and to the owners' benefit, without intent to infringe.

# Contents

Notices.....	vi
Safety information .....	vii
About this guide .....	vii
M4A77D specifications summary.....	ix

## Chapter 1: Product introduction

<b>1.1</b>	<b>Welcome!</b> .....	<b>1-1</b>
<b>1.2</b>	<b>Package contents</b> .....	<b>1-1</b>
<b>1.3</b>	<b>Special features</b> .....	<b>1-1</b>
	1.3.1 Product highlights .....	1-1
	1.3.2 Innovative ASUS features.....	1-3
<b>1.4</b>	<b>Before you proceed</b> .....	<b>1-5</b>
<b>1.5</b>	<b>Motherboard overview</b> .....	<b>1-6</b>
	1.5.1 Placement direction .....	1-6
	1.5.2 Screw holes .....	1-6
	1.5.3 Motherboard layout.....	1-7
	1.5.4 Layout contents.....	1-7
<b>1.6</b>	<b>Central Processing Unit (CPU)</b> .....	<b>1-8</b>
	1.6.1 Installing the CPU .....	1-8
	1.6.2 Installing the heatsink and fan .....	1-10
<b>1.7</b>	<b>System memory</b> .....	<b>1-11</b>
	1.7.1 Overview .....	1-11
	1.7.2 Memory configurations.....	1-12
	1.7.3 Installing a DIMM .....	1-17
	1.7.4 Removing a DIMM .....	1-17
<b>1.8</b>	<b>Expansion slots</b> .....	<b>1-18</b>
	1.8.1 Installing an expansion card .....	1-18
	1.8.2 Configuring an expansion card .....	1-18
	1.8.3 PCI slots.....	1-18
	1.8.4 PCI Express x1 slots.....	1-18
	1.8.5 PCI Express x16 slot.....	1-18
<b>1.9</b>	<b>Jumpers</b> .....	<b>1-19</b>
<b>1.10</b>	<b>Connectors</b> .....	<b>1-20</b>
	1.10.1 Rear panel ports .....	1-20
	1.10.2 Internal connectors .....	1-22

# Contents

- 1.11 **Software support**..... 1-29
  - 1.11.1 Installing an operating system ..... 1-29
  - 1.11.2 Support DVD information ..... 1-29

## Chapter 2: BIOS information

- 2.1 **Managing and updating your BIOS** ..... 2-1
  - 2.1.1 ASUS Update utility ..... 2-1
  - 2.1.2 ASUS EZ Flash 2 ..... 2-2
  - 2.1.3 ASUS CrashFree BIOS..... 2-3
- 2.2 **BIOS setup program** ..... 2-4
  - 2.2.1 BIOS menu screen..... 2-5
  - 2.2.2 Menu bar..... 2-5
  - 2.2.3 Navigation keys..... 2-5
  - 2.2.4 Menu items ..... 2-6
  - 2.2.5 Submenu items ..... 2-6
  - 2.2.6 Configuration fields ..... 2-6
  - 2.2.7 Pop-up window ..... 2-6
  - 2.2.8 Scroll bar..... 2-6
  - 2.2.9 General help ..... 2-6
- 2.3 **Main menu** ..... 2-7
  - 2.3.1 System Time ..... 2-7
  - 2.3.2 System Date ..... 2-7
  - 2.3.3 Primary IDE Master/Slave, SATA 1/2/3/4/5/6..... 2-7
  - 2.3.4 SATA Configuration ..... 2-8
  - 2.3.5 System Information ..... 2-9
- 2.4 **Advanced menu** ..... 2-9
  - 2.4.1 JumperFree Configuration ..... 2-9
  - 2.4.2 CPU Configuration ..... 2-12
  - 2.4.3 Chipset..... 2-13
  - 2.4.4 Onboard Device Configuration..... 2-14
  - 2.4.5 PCI/PhP ..... 2-14
  - 2.4.6 USB Configuration ..... 2-15
- 2.5 **Power menu**..... 2-16
  - 2.5.1 Suspend Mode..... 2-16
  - 2.5.2 ACPI 2.0 Support ..... 2-16

# Contents

2.5.3	ACPI APIC Support .....	2-16
2.5.4	APM Configuration.....	2-16
2.5.5	HW Monitor Configuration.....	2-17
<b>2.6</b>	<b>Boot menu .....</b>	<b>2-18</b>
2.6.1	Boot Device Priority .....	2-18
2.6.2	Boot Settings Configuration .....	2-18
2.6.3	Security .....	2-19
<b>2.7</b>	<b>Tools menu .....</b>	<b>2-20</b>
2.7.1	ASUS EZ Flash 2.....	2-20
2.7.2	Express Gate .....	2-21
2.7.3	AI NET 2.....	2-21
<b>2.8</b>	<b>Exit menu .....</b>	<b>2-22</b>

# Notices

## Federal Communications Commission Statement

This device complies with Part 15 of the FCC Rules. Operation is subject to the following two conditions:

- This device may not cause harmful interference, and
- This device must accept any interference received including interference that may cause undesired operation.

This equipment has been tested and found to comply with the limits for a Class B digital device, pursuant to Part 15 of the FCC Rules. These limits are designed to provide reasonable protection against harmful interference in a residential installation. This equipment generates, uses and can radiate radio frequency energy and, if not installed and used in accordance with manufacturer's instructions, may cause harmful interference to radio communications. However, there is no guarantee that interference will not occur in a particular installation. If this equipment does cause harmful interference to radio or television reception, which can be determined by turning the equipment off and on, the user is encouraged to try to correct the interference by one or more of the following measures:

- Reorient or relocate the receiving antenna.
- Increase the separation between the equipment and receiver.
- Connect the equipment to an outlet on a circuit different from that to which the receiver is connected.
- Consult the dealer or an experienced radio/TV technician for help.



---

The use of shielded cables for connection of the monitor to the graphics card is required to assure compliance with FCC regulations. Changes or modifications to this unit not expressly approved by the party responsible for compliance could void the user's authority to operate this equipment.

---

## Canadian Department of Communications Statement

This digital apparatus does not exceed the Class B limits for radio noise emissions from digital apparatus set out in the Radio Interference Regulations of the Canadian Department of Communications.

This class B digital apparatus complies with Canadian ICES-003.

## REACH

Complying with the REACH (Registration, Evaluation, Authorisation, and Restriction of Chemicals) regulatory framework, we published the chemical substances in our products at ASUS REACH website at <http://green.asus.com/english/REACH.htm>.



---

**DO NOT** throw the motherboard in municipal waste. This product has been designed to enable proper reuse of parts and recycling. This symbol of the crossed out wheeled bin indicates that the product (electrical and electronic equipment) should not be placed in municipal waste. Check local regulations for disposal of electronic products.

---



---

**DO NOT** throw the mercury-containing button cell battery in municipal waste. This symbol of the crossed out wheeled bin indicates that the battery should not be placed in municipal waste.

---

# Safety information

## Electrical safety

- To prevent electric shock hazard, disconnect the power cable from the electric outlet before relocating the system.
- When adding or removing devices to or from the system, ensure that the power cables for the devices are unplugged before the signal cables are connected. If possible, disconnect all power cables from the existing system before you add a device.
- Before connecting or removing signal cables from the motherboard, ensure that all power cables are unplugged.
- Seek professional assistance before using an adapter or extension cord. These devices could interrupt the grounding circuit.
- Ensure that your power supply is set to the correct voltage in your area. If you are not sure about the voltage of the electrical outlet you are using, contact your local power company.
- If the power supply is broken, do not try to fix it by yourself. Contact a qualified service technician or your retailer.

## Operation safety

- Before installing the motherboard and adding devices on it, carefully read all the manuals that came with the package.
- Before using the product, ensure that all cables are correctly connected and the power cables are not damaged. If you detect any damage, contact your dealer immediately.
- To avoid short circuits, keep paper clips, screws, and staples away from connectors, slots, sockets and circuitry.
- Avoid dust, humidity, and temperature extremes. Do not place the product in any area where it may become wet.
- Place the product on a stable surface.
- If you encounter technical problems with the product, contact a qualified service technician or your retailer.

## About this guide

This user guide contains the information you need when installing and configuring the motherboard.

### How this guide is organized

This guide contains the following parts:

- **Chapter 1: Product introduction**  
This chapter describes the features of the motherboard and the new technology it supports.
- **Chapter 2: BIOS information**  
This chapter tells how to change system settings through the BIOS Setup menus. Detailed descriptions of the BIOS parameters are also provided.

## Conventions used in this guide

To ensure that you perform certain tasks properly, take note of the following symbols used throughout this manual.



**DANGER/WARNING:** Information to prevent injury to yourself when trying to complete a task.



**CAUTION:** Information to prevent damage to the components when trying to complete a task.



**IMPORTANT:** Instructions that you **MUST** follow to complete a task.



**NOTE:** Tips and additional information to help you complete a task.

## Where to find more information

Refer to the following sources for additional information and for product and software updates.

### 1. ASUS websites

The ASUS website provides updated information on ASUS hardware and software products. Refer to the ASUS contact information.

### 2. Optional documentation

Your product package may include optional documentation, such as warranty flyers, that may have been added by your dealer. These documents are not part of the standard package.

## Typography

### **Bold text**

Indicates a menu or an item to select.

### *Italics*

Used to emphasize a word or a phrase.

### <Key>

Keys enclosed in the less-than and greater-than sign means that you must press the enclosed key.

Example: <Enter> means that you must press the Enter or Return key.

### <Key1>+<Key2>+<Key3>

If you must press two or more keys simultaneously, the key names are linked with a plus sign (+).

Example: <Ctrl>+<Alt>+<D>



## M4A77D specifications summary

<b>CPU</b>	AMD® AM3/AM2+/AM2; Phenom™ II / Athlon™ II / Phenom™ / Athlon™ / Sempron™ Family processors AMD Cool 'n' Quiet™ Technology Support CPU up to 140W * Refer to <a href="http://www.asus.com">www.asus.com</a> for the AMD® CPU support list.
<b>Chipset</b>	AMD® 770 / SB710
<b>Front Side Bus</b>	Up to 5200MT/s HyperTransport™ 3.0 interface for AM2+/AM3 CPU
<b>Memory</b>	Dual-channel memory architecture 4 x 240-pin DIMM slots support maximum 16GB unbuffered ECC and non-ECC DDR2 1200(O.C.)/1066/800/667/533MHz memory modules * We recommend that you install the DDR2 1200(O.C.) DIMMs on the blue slots for better performance. ** DDR2 1200(O.C.)/1066 is supported by AM3/AM2+ CPU only. *** Due to AM3/AM2+ CPU limitation, only one DDR2 1200(O.C.)/1066 is supported per channel. ****Refer to <a href="http://www.asus.com">www.asus.com</a> for the latest Memory QVL (Qualified Vendors List). ***** When you install a total memory of 4GB or more, Windows® 32-bit operating system may only recognize less than 3GB. We recommend a maximum of 3GB system memory if you are using a Windows® 32-bit operating system.
<b>Expansion slots</b>	1 x PCI Express™ x16 slot 2 x PCI Express™ x1 slots 3 x PCI slots
<b>Storage</b>	1 x Ultra DMA 133/100 connector 6 x Serial ATA 3Gb/s connectors support RAID 0, RAID 1, RAID 0+1, and JBOD configurations
<b>Audio</b>	VT1818S 8-channel High Definition Audio CODEC <ul style="list-style-type: none"> <li>– Blu-ray disc audio layer Content Protection</li> <li>– Optical S/PDIF out port at back I/O</li> <li>– Supports Jack-detection, Multi-streaming, and Front Panel Jack-Retasking technologies</li> </ul>
<b>USB</b>	Supports up to 12 USB 2.0/1.1 ports (6 ports at mid-board, 6 ports at the back panel)
<b>LAN</b>	Realtek® RTL8112L PCIe Gigabit LAN controller

*(continued on the next page)*

## M4A77D specifications summary

<b>ASUS unique features</b>	<p>ASUS Quiet Thermal Solution:</p> <ul style="list-style-type: none"> <li>- ASUS Q-Fan</li> </ul> <p>ASUS EZ DIY:</p> <ul style="list-style-type: none"> <li>- ASUS CrashFree BIOS 3</li> <li>- ASUS EZ Flash 2</li> </ul> <p>ASUS AI NET2 Stack Cool 3 ASUS Turbo Key ASUS MyLogo 2 ASUS EPU-4 Engine ASUS Express Gate</p>
<b>Back panel I/O ports</b>	<p>1 x PS/2 Keyboard port 1 x IEEE 1394a port 1 x LPT port 1 x COM port 1 x Optical S/PDIF Out port 1 x LAN (RJ-45) port 6 x USB 2.0/1.1 ports 8-channel audio I/O ports</p>
<b>Internal I/O connectors</b>	<p>3 x USB 2.0/1.1 connectors support additional 6 USB 2.0/1.1 ports 1 x IDE connector 6 x SATA connectors 1 x Front panel audio connector 1 x System panel connector 1 x S/PDIF Out connector 1 x IEEE 1394a connector 1 x CPU fan connector 1 x Chassis fan connector 1 x 24-pin EATX power connector 1 x 4-pin ATX 12V power connector</p>
<b>BIOS</b>	<p>8Mb Flash ROM, AMI BIOS, PnP, DMI v2.0, WfM2.0, SM BIOS v2.5, ACPI v2.0a,</p>
<b>Accessories</b>	<p>1 x Ultra DMA 133/100 cable 2 x Serial ATA cables 1 x I/O shield 1 x User Manual</p>
<b>Support DVD</b>	<p>Drivers ASUS Update ASUS PC Probe II Anti-Virus software (OEM version)</p>
<b>Form factor</b>	<p>ATX form factor: 12 in x 8.4 in (30.6 cm x 21.4 cm)</p>

\* Specifications are subject to change without notice.

# Chapter 1

## Product introduction

### 1.1 Welcome!

Thank you for buying an ASUS® M4A77D motherboard!

The motherboard delivers a host of new features and latest technologies, making it another standout in the long line of ASUS quality motherboards!

Before you start installing the motherboard, and hardware devices on it, check the items in your package with the list below.

### 1.2 Package contents

Check your motherboard package for the following items.

Motherboard	ASUS M4A77D motherboard
Cables	2 x Serial ATA cables 1 x Ultra DMA 133/100 cable
Accessories	1 x I/O shield
Application DVD	ASUS motherboard Support DVD
Documentations	User Manual



If any of the above items is damaged or missing, contact your retailer.

### 1.3 Special features

#### 1.3.1 Product highlights



#### AMD® Phenom™ II / Athlon™ II / Sempron™ 100 series (AM3 CPU)

This motherboard supports AMD® AM3 multi-core processors with unique L3 cache and delivers better overclocking capabilities with less power consumption. It features dual-channel DDR2 1066 memory support and accelerates data transfer rate up to 5200MT/s via HyperTransport™ 3.0-based system bus. This motherboard also supports AMD® CPUs in the new 45nm manufacturing process.



## AMD® Phenom™ X4 / Phenom™ X3 / Athlon™ X2 / Athlon™ / Sempron™ processors (socket AM2+/AM2)



This motherboard supports AMD® Socket AM2+ multi-core processors. It features dual-channel DDR2 1066 memory support, data transfer rate up to 5200MT/s via HyperTransport™ 3.0 based system bus, and AMD® Cool 'n' Quiet™ Technology.



## AMD® 770 Chipset

The AMD® 770 Chipset is designed to support up to 5200MT/s HyperTransport™ 3.0 (HT 3.0) interface speed and PCI Express 2.0 x16 graphics. It is optimized with AMD's latest AM3 multi-core CPUs to provide excellent system performance and overclocking capabilities.

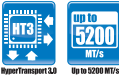

## HyperTransport™ 3.0 support

HyperTransport™ 3.0 technology provides 2.6 times more bandwidth than HT1.0 that radically improves system efficiency for a smoother and faster computing environment.



## AMD Cool 'n' Quiet Technology

This motherboard supports the AMD Cool 'n' Quiet technology which monitors system operation and automatically adjusts CPU voltage and frequency for a cool and quiet operating environment.



## DDR2 1200(O.C.) support

This motherboard supports DDR2 1200 (O.C.) that provides faster data transfer rate and more bandwidth to increase memory computing efficiency, enhancing system performance in 3D graphics and other memory demanding applications.



## S/PDIF digital sound ready

This motherboard provides convenient connectivity to external home theater audio systems via coaxial and optical S/PDIF\_OUT (SONY-PHILIPS Digital Interface) jacks. The S/PDIF transfers digital audio without converting it to analog format and keeps the best signal quality.



## 64-bit CPU support

64-bit computing replaces the current 32-bit architecture, delivers advanced system performance, faster memory access, and increased productivity. This motherboard provides excellent compatibility and flexibility by supporting both 64-bit and 32-bit architecture.



### Serial ATA 3Gb/s technology

This motherboard supports hard drives based on the Serial ATA (SATA) 3Gb/s storage specifications, delivering enhanced salability and doubling the bus bandwidth for high-speed data saving and retrieval.



### 8-channel high definition audio

The onboard 8-channel HD audio (High Definition Audio, previously codenamed Azalia) CODEC enables high-quality 192KHz/24-bit audio output and jack-detect feature that automatically detects and identifies what types of peripherals are plugged into the audio I/O jacks and notifies users of inappropriate connection, which means there will be no more confusion of Line-in, Line-out, and Mic jacks.



### Gigabit LAN solution

The onboard LAN controller is a highly integrated Gb LAN controller. It is enhanced with an ACPI management function to provide efficient power management for advanced operating systems.



### PCI Express 2.0 support

This motherboard supports PCI Express 2.0 devices for double speed and bandwidth which enhances system performance.

## 1.3.2 Innovative ASUS features



### ASUS Express Gate

ASUS Express Gate is an instant-on environment that gives you quick access to the Internet. Five seconds after powering on your computer, you can instantly surf the Internet without entering the Windows® OS.



- ASUS Express Gate supports installation on SATA HDDs, USB HDDs and flash drives with at least 1.2GB free disk space. When installing it on USB HDDs or flash drives, connect the drives to the motherboard USB port before turning on the computer.
- The actual boot time depends on the system configuration.
- ASUS Express Gate supports file uploading from SATA HDDs, ODDs and USB drives. It supports file downloading to USB drives only.
- ASUS Express Gate complies with the OpenGL standard. Refer to [support.asus.com](http://support.asus.com) for Express Gate source codes.



### ASUS CrashFree BIOS 3

ASUS CrashFree BIOS 3 is an auto-recovery tool that allows you to restore a corrupted BIOS file using the bundled support DVD or a USB flash disk that contains the BIOS file.



## ASUS EZ Flash 2

ASUS EZ Flash 2 allows you to update the BIOS from a USB flash disk before entering the OS.



## ASUS EPU

ASUS EPU is a unique power saving technology that detects the current system loadings and adjusts the power consumption in real time.



## ASUS Turbo Key

ASUS Turbo Key allows you to turn the PC power button into an overclocking button. After the easy setup, Turbo Key boosts performances without interrupting ongoing work or games, simply through pressing the button.



## ASUS MyLogo 2™

Turn your favorite photos into 256-color boot logos to personalize your system.



## ASUS Q-Fan

ASUS Q-Fan technology intelligently adjusts CPU fan speeds according to system loading to ensure a quiet, cool, and efficient operation.



## ASUS AI NET 2

ASUS AI NET 2 remotely detects the cable connection immediately after you turn on the system and any faulty cable connections are reported back up to 100 meters at 1 meter accuracy.



## C.P.R. (CPU Parameter Recall)

The BIOS C.P.R. feature automatically restores the CPU default settings when the system hangs due to overclocking failure. C.P.R. eliminates the need to open the system chassis and clear the RTC data. Simply shut down and reboot the system, and the BIOS automatically restores the CPU parameters to their default settings.



## Green ASUS

This motherboard and its packaging comply with the European Union's Restriction on the use of Hazardous Substances (RoHS). This is in line with the ASUS vision of creating environment-friendly and recyclable products/packaging to safeguard consumers' health while minimizing the impact on the environment.

## 1.4 Before you proceed

Take note of the following precautions before you install motherboard components or change any motherboard settings.



- Unplug the power cord from the wall socket before touching any component.
- Before handling components, use a grounded wrist strap or touch a safely grounded object or a metal object, such as the power supply case, to avoid damaging them due to static electricity.
- Hold components by the edges to avoid touching the ICs on them.
- Whenever you uninstall any component, place it on a grounded antistatic pad or in the bag that came with the component.
- Before you install or remove any component, switch off the ATX power supply and detach its power cord. Failure to do so may cause severe damage to the motherboard, peripherals, or components.

### Onboard LED

The motherboard comes with a standby power LED that lights up to indicate that the system is ON, in sleep mode, or in soft-off mode. This is a reminder that you should shut down the system and unplug the power cable before removing or plugging in any motherboard component. The illustration below shows the location of the onboard LED.

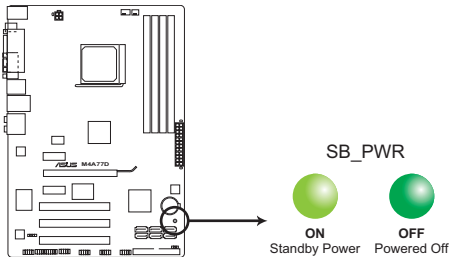

**M4A77D Onboard LED**

## 1.5 Motherboard overview

### 1.5.1 Placement direction

When installing the motherboard, ensure that you place it into the chassis in the correct orientation. The edge with external ports goes to the rear part of the chassis as indicated in the image below.

### 1.5.2 Screw holes

Place six screws into the holes indicated by circles to secure the motherboard to the chassis.



DO NOT overtighten the screws! Doing so can damage the motherboard.

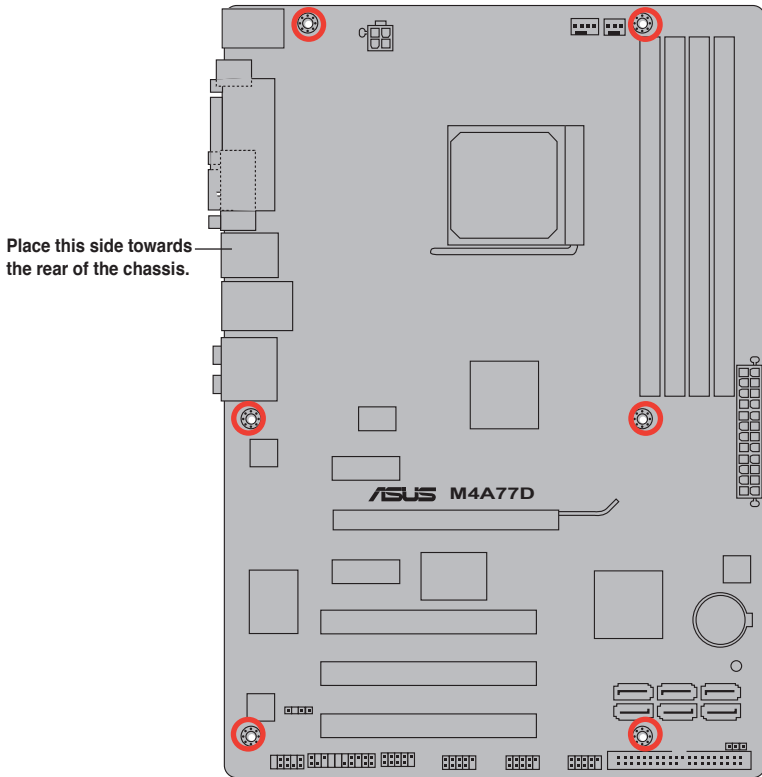



## 1.5.3 Motherboard layout

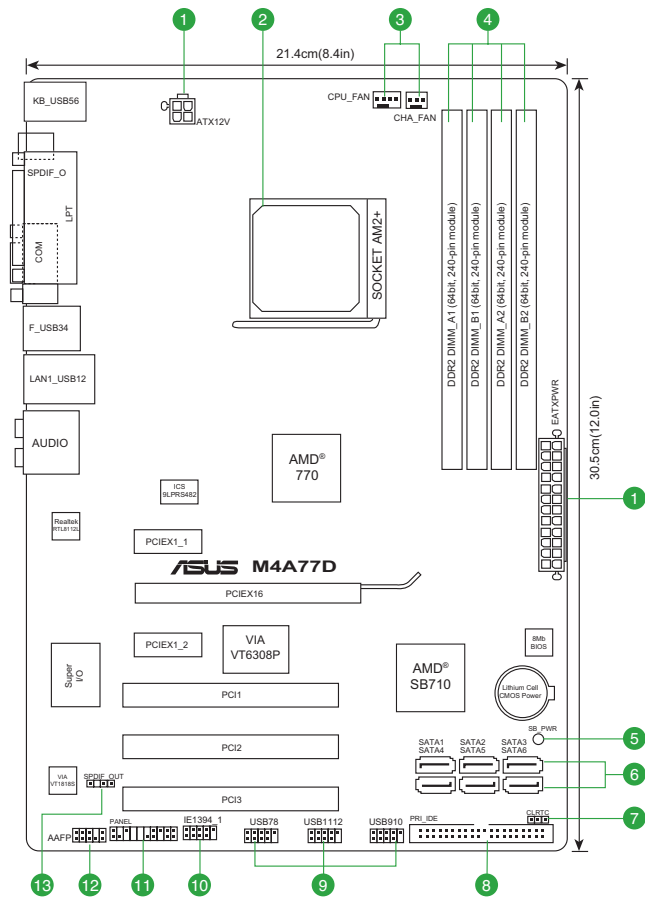

## 1.5.4 Layout contents

Connectors/Jumpers/Slots/LED	Page	Connectors/Jumpers/Slots/LED	Page
1. ATX power connectors (24-pin EATXPWR, 4-pin ATX12V)	1-22	8. IDE connector (40-1 pin PRL_IDE)	1-23
2. AMD CPU socket	1-8	9. USB connectors (10-1 pin USB78, USB910, USB1112)	1-26
3. CPU and chassis fan connectors (4-pin CPU_FAN, 3-pin CHA_FAN)	1-28	10. IEEE 1394a connector (10-1 pin IE1394_1)	1-28
4. DDR2 DIMM sockets	1-11	11. System panel connector (20-8 pin PANEL)	1-25
5. Onboard LED	1-5	12. Front panel audio connector (10-1 pin AAFF)	1-27
6. Serial ATA connectors (7-pin SATA1, SATA2, SATA3, SATA4, SATA5, SATA6)	1-24	13. Digital audio connector (4-1 pin SPDIF_OUT)	1-27
7. Clear RTC RAM (CLRTC)	1-19		

## 1.6 Central Processing Unit (CPU)

This motherboard supports AM3/AM2/AM2+ CPUs including AMD® Phenom™ II / Athlon™ II/ Phenom™ / Athlon™ / Sempron™ proc



The AM2/AM2+ socket has a different pinout from the 940-pin socket designed for the AMD Opteron™ processor. Use a CPU that is designed for the AM2/AM2+ socket.

### 1.6.1 Installing the CPU

To install a CPU:

1. Locate the CPU socket on the motherboard.

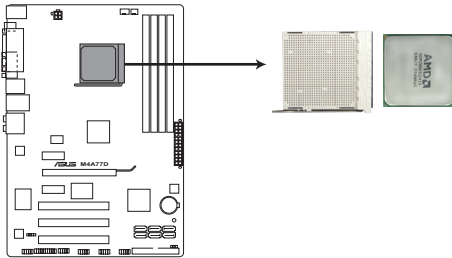

**M4A77D CPU socket AM2+**

2. Press the lever sideways to unlock the socket, then lift it up to a 90°-100° angle.

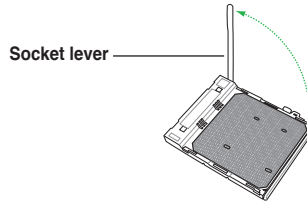

Ensure that the socket lever is lifted up to a 90°-100° angle; otherwise, the CPU will not fit in completely.

3. Position the CPU above the socket such that the CPU corner with the gold triangle matches the socket corner with a small triangle.
4. Carefully insert the CPU into the socket until it fits in place.



The CPU fits only in one correct orientation. **DO NOT** force the CPU into the socket to prevent bending the pins and damaging the CPU!

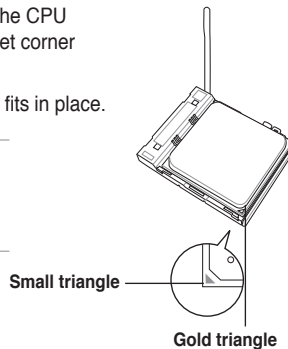

- When the CPU is in place, push down the socket lever to secure the CPU. The lever clicks on the side tab to indicate that it is locked.
- Install a CPU heatsink and fan following the instructions that comes with the heatsink package. You can also refer to section **1.6.2 Installing heatsink and fan** for instructions.
- Connect the CPU fan cable to the CPU\_FAN connector on the motherboard.

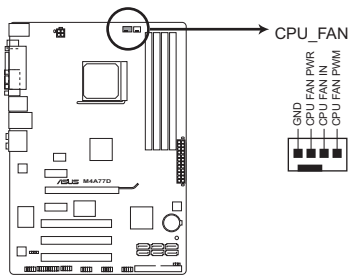
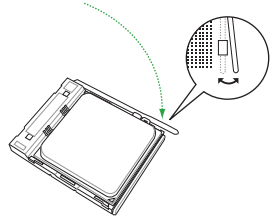

**M4A77D CPU fan connector**



---

DO NOT forget to connect the CPU fan connector! Hardware monitoring errors can occur if you fail to plug this connector.

---

## 1.6.2 Installing the heatsink and fan



Ensure that you use only AMD-certified heatsink and fan assembly.

To install the CPU heatsink and fan:

1. Place the heatsink on top of the installed CPU, ensuring that the heatsink fits properly on the retention module base.



- The retention module base is already installed on the motherboard upon purchase.
- You do not have to remove the retention module base when installing the CPU or installing other motherboard components.
- If you purchased a separate CPU heatsink and fan assembly, ensure that a Thermal Interface Material is properly applied to the CPU heatsink or CPU before you install the heatsink and fan assembly.

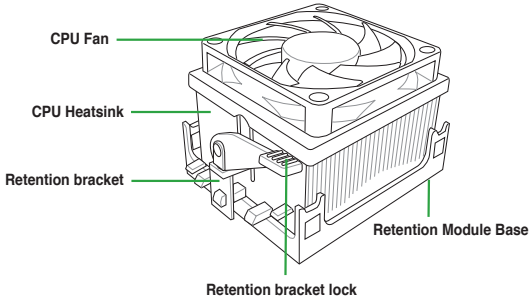

Your boxed CPU heatsink and fan assembly should come with installation instructions for the CPU, heatsink, and the retention mechanism. If the instructions in this section do not match the CPU documentation, follow the latter.

2. Attach one end of the retention bracket to the retention module base.

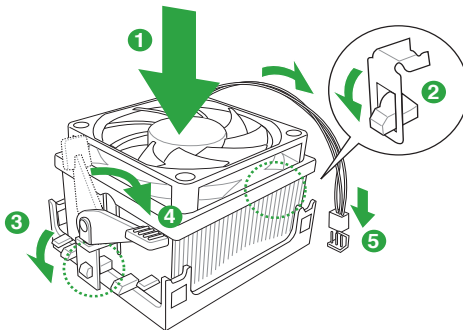

- Align the other end of the retention bracket to the retention module base. A clicking sound denotes that the retention bracket is in place.



Ensure that the fan and heatsink assembly perfectly fits the retention mechanism module base, otherwise you cannot snap the retention bracket in place.

- Push down the retention bracket lock on the retention mechanism to secure the heatsink and fan to the module base.
- When the fan and heatsink assembly is in place, connect the CPU fan cable to the connector on the motherboard labeled CPU\_FAN.



DO NOT forget to connect the CPU fan connector! Hardware monitoring errors can occur if you fail to plug this connector.

## 1.7 System memory

### 1.7.1 Overview

The motherboard comes with four Double Data Rate 2 (DDR2) Dual Inline Memory Modules (DIMM) sockets. A DDR2 module has the same physical dimensions as a DDR DIMM but has a 240-pin footprint compared to the 184-pin DDR DIMM. DDR2 DIMMs are notched differently to prevent installation on a DDR DIMM socket. The figure illustrates the location of the DDR2 DIMM sockets:

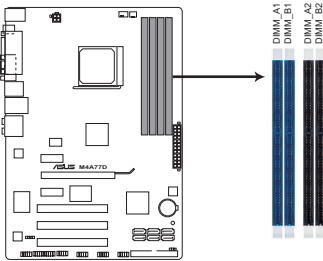

Channel	Sockets
Channel A	DIMM_A1 and DIMM_A2
Channel B	DIMM_B1 and DIMM_B2

**M4A77D 240-pin DDR2 DIMM sockets**

## 1.7.2 Memory configurations

You may install 512MB, 1GB, 2GB, and 4GB unbuffered ECC and non-ECC DDR2 DIMMs into the DIMM sockets.



- You may install varying memory sizes in Channel A and Channel B. The system maps the total size of the lower-sized channel for the dual-channel configuration. Any excess memory from the higher-sized channel is then mapped for single-channel operation.
- Always install DIMMs with the same CAS latency. For optimum compatibility, we recommend that you obtain memory modules from the same vendor.
- Due to the memory address limitation on 32-bit Windows® OS, when you install 4GB or more memory on the motherboard, the actual usable memory for the OS can be about 3GB or less. For effective use of memory, we recommend that you do any of the following:
  - Install a maximum of 3GB system memory if you are using a 32-bit Windows® OS.
  - Use a 64-bit Windows® OS if you want to install 4GB or more memory on the motherboard.
- This motherboard does not support DIMMs made up of 256 megabits (Mb) chips or less.

## M4A77D Motherboard Qualified Vendors Lists (QVL)

### DDR2-533MHz capability

Size	Vendor	Part No.	SS/ DS	CL	Chip No.	Chip Brand	DIMM support		
							A*	B*	C*
512MB	Kingston	KVR533D2N4/512	SS	N/A	HYB18T512808AF3S	Qimonda	-	-	-
1G	Kingston	KVR533D2N4/1G	DS	N/A	HY5PS12821EFP-Y5	Hynix	-	-	-
1G	HY	HYMP512U64CP8-C4 AB	DS	4	HY5PS12821CFP-C4	Hynix	-	-	-
512MB	Elpida	EBE51UD8ABFA-5C-E	SS	N/A	E5108AB-5C-E	Elpida	-	-	-
512MB	Transcend	512MB DDR2 533 ECC	SS	N/A	6ND22D9GCT(ECC)	Micron	-	-	-
512MB	Kingmax	KLBC28F-A8KB4	SS	N/A	KKEA88B4IAK-37	Kingmax	-	-	-
1G	Elixir	M2Y1G64TU8HBOB-37B	DS	4	N2TU51280BE-37B61921300CP	Elixir	-	-	-

## DDR2-667MHz capability

Size	Vendor	Part No.	SS/ DS	CL	Chip No.	Chip Brand	DIMM support		
							A*	B*	C*
2G	Kingston	KVR667D2N5/2G	DS	N/A	7RE22 D9HNL	Micron	-	-	-
512MB	Kingston	KVR667D2N5/512	SS	N/A	SO1237650821 SBP D6408TR4 CGL25USL074905PECNB	Kingston	-	-	-
2G	Kingston	KVR667D2N5/2G	DS	N/A	E1108ACBG-8E-E 0813A90CC	Elpida	-	-	-
1G	Kingston	KVR667D2N5/1G	DS	N/A	SO1280420822 SOP D6408TR4 CGL25USL156304PECCA	Kingston	-	-	-
512MB	Qimonda	HYS64T64000EU-3S-B2	SS	5	HYB18T512B00B2F3SFS S28171	Qimonda	-	-	-
1G	Qimonda	HYS64T128020EU-3S-B2	DS	5	HYB18T512B00B2F3SFS S28171	Qimonda	-	-	-
1G	Corsair	VS1GB667D2	DS	N/A	MID095D62864M8CEC	Corsair	-	-	-
1G	Corsair	XMS2-5400	DS	4	Heat-Sink Package	Corsair	-	-	-
512MB	Kingmax	KLCC28F-A8KB5	SS	N/A	KKEA88B4LAUG-29DX	Kingmax	-	-	-
1G	Kingmax	KLCD48F-A8KB5	DS	N/A	KKEA88B4LAUG-29DX	Kingmax	-	-	-
512MB	Apacer	AU512E667C5KBGC	SS	5	AM4B5708MIJS7E0627B	Apacer	-	-	-
512MB	Apacer	AU512E667C5KBGC	SS	5	AM4B5708GQJS7E06332F	Apacer	-	-	-
512MB	Apacer	78.91G92.9K5	SS	5	AM4B5708JQJS7E0751C	Apacer	-	-	-
1G	Apacer	78.01G90.9K5	SS	5	AM4B5808CQJS7E0751C	Apacer	-	-	-
1G	Apacer	AU01GE667C5KBGC	DS	N/A	AM4B5708GQJS7E0636B	Apacer	-	-	-
1G	Apacer	AU01GE667C5KBGC	DS	5	AM4B5708MIJS7E0627B	Apacer	-	-	-
2G	Apacer	78.A1G90.9K4	DS	5	AM4B5808CQJS7E0749B	Apacer	-	-	-
1G	Transcend	506010-4894	DS	5	E5108AJBG-6E-E	Elpida	-	-	-
512MB	ADATA	M20AD5G3H3160Q1C52	SS	N/A	AD29608A8A-3EG20813	ADATA	-	-	-
1G	ADATA	M20AD5G314170Q1C58	DS	N/A	AD29608A8A-3EG80814	ADATA	-	-	-
2G	ADATA	M20AD5H3J4170H1C53	DS	N/A	AD20908A8A-3EG 30724	ADATA	-	-	-
512MB	PSC	AL6E8E63J-6E1	SS	5	A3R12E3JFF717B9A00	PSC	-	-	-
1G	PSC	AL7E8E63J-6E1	DS	5	A3R12E3JFF717B9A01	PSC	-	-	-
1G	PSC	AL7E8F73C-6E1	SS	5	A3R1GE3CFF734MAA0J	PSC	-	-	-
512MB	Nanya	NT512T64U88A1BY-3C	SS	N/A	NT5TU64M8AE-3C	Nanya	-	-	-
1G	Nanya	NT1GT64U88B0BY-3C	DS	5	NT5TU64M8BE-3C72155700CP	Nanya	-	-	-
1G	GEIL	GX21GB5300SX	DS	3	Heat-Sink Package	GEIL	-	-	-
2G	GEIL	GX24GB5300LDC	DS	5	Heat-Sink Package	GEIL	-	-	-
2G(kit of 2)	G.SKILL	F2-5400PHU2-2GBNT	DS	5-5-5-15	D2 64M8CCF 0815 C7173S	G.SKILL	-	-	-
4G(kit of 2)	G.SKILL	F2-5300CL5D-4GBMQ	DS	5-5-5-15	Heat-Sink Package	G.SKILL	-	-	-
512MB	Twinmos	8D-A3JK5MPETP	SS	5	A3R12E3GEF633ACA0Y	PSC	-	-	-
4G	Samsung	M378T5263AZ3-CE6	DS	N/A	K4T2G084QA-HCE6	Samsung	-	-	-
1G	ELIXIR	M2Y1G64TU8HA2B-3C	DS	5	M2TU51280AE-3C717095R28F	ELIXIR	-	-	-
1G	ELIXIR	M2Y1G64TU8HBOB-3C	DS	5	N2TU51280BE-3C639009W1CF	ELIXIR	-	-	-
1G	Leadmax	LRMP512U64A8-Y5	DS	N/A	HY5PS12821CFP-Y5 C 702AA	Hynix	-	-	-

## DDR2-800MHz capability

Size	Vendor	Part No.	SS/DS	CL	Chip No.	Chip Brand	DIMM support		
							A*	B*	C*
1G	Kingston	KHX6400D2LL/1G	DS	N/A	Heat-Sink Package	Kingston	-	-	-
512MB	Kingston	KHX6400D2LLK2/1GN	SS	N/A	Heat-Sink Package	Kingston	-	-	-
512MB	Kingston	KVR800D2N6/512	SS	N/A	E5108AJBG-8E-E	Elpida	-	-	-
1G	Kingston	KVR800D2N5/1G	DS	N/A	D6408TR4CGL25USL36240 6PECCA	Kingston	-	-	-
2G	Kingston	KVR800D2N5/2G	DS	N/A	E1108ACBG-8E-E	Elpida	-	-	-
2G	Kingston	KHX6400D2/2G	DS	N/A	Heat-Sink Package	Kingston	-	-	-
4G	Kingston	KVR800D2N6/4G	DS	N/A	E2108ABSE-8G-E	Elpida	-	-	-
512MB	Kingston	KVR800D2N5/512	SS	N/A	E5108AJBG-8E-E 0803A9082	Kingston	-	-	-
512MB	Samsung	M378T6553GZ3-CF7	SS	6	K4T51083QG-HCF7	Samsung	-	-	-
1G	Samsung	M378T2863QZ3-CF7	SS	6	K4T1G084QG-HCF7	Samsung	-	-	-
1G	Samsung	M391T2863QZ3-CF7	SS	6	K4T1G084QG-HCF7(ECC)	Samsung	-	-	-
1G	Samsung	M378T2953GZ3-CF7	DS	6	K4T51083QG-HCF7	Samsung	-	-	-
2G	Samsung	M378T5663QZ3-CF7	DS	6	K4T1G084QG-HCF7	Samsung	-	-	-
2G	Samsung	M391T5663QZ3-CF7	DS	6	K4T1G084QG-HCF7(ECC)	Samsung	-	-	-
4G	Samsung	M378T5263AZ3-CF7	DS	N/A	K4T2G084QA-HCF7	Samsung	-	-	-
512MB	Qimonda	HYS64T64000EU-2.5-B2	SS	6	HYB18T512800B2F25FSS28380	Qimonda	-	-	-
512MB	Micron	MT9HTF6472AY-80ED4	SS	5	6ED22D9GKX(ECC)	Micron	-	-	-
1G	Micron	MT9HTF12872AY-800E1	SS	6	D9HNP 7YE22(ECC)	Micron	-	-	-
1G	Micron	MT18HTF12872AY-80ED4	DS	5	6TD22D9GKX(ECC)	Micron	-	-	-
1G	Corsair	XMS2-6400	DS	4	Heat-Sink Package	Corsair	-	-	-
1G	Corsair	XMS2-6400	DS	5	Heat-Sink Package	Corsair	-	-	-
4G(Kit of 2)	Corsair	CM2X2048-6400C5DHX	DS	5	Heat-Sink Package	Corsair	-	-	-
4G(Kit of 2)	Corsair	CM2X2048-6400C5	DS	5	Heat-Sink Package	Corsair	-	-	-
2G(Kit of 2) (EPP)	Crucial	BL12864AA804.8FE5	SS	N/A	Heat-Sink Package	N/A	-	-	-
512MB	HY	HYMP564U64CP8-S5 AB	SS	5	HY5PS12821CFP-S5	Hynix	-	-	-
1G	HY	HYMP512U64CP8-S5 AB	DS	5	HY5PS12821CFPS5	Hynix	-	-	-
512MB	Kingmax	KLDC28F-A8K15	SS	N/A	KKA8FF1XF-JFS-25A	Kingmax	-	-	-
1G	Kingmax	KLDD48F-B8KB5	SS	N/A	KKB8FFBFX-CFA-25U	Kingmax	-	-	-
2G	Kingmax	KLDE88F-B8KB5	DS	N/A	KKB8FFBFX-CFA-25U	Kingmax	-	-	-
1G	Apacer	78.01GA0.9K5	SS	5	AM4B5808CQJS8E0749D	Apacer	-	-	-
2G	Apacer	78.A1GA0.9K4	DS	5	AM4B5808CQJS8E0740E	Apacer	-	-	-
512MB	Transcend	TS64MLQ64V8J512MB	SS	5	7HD22 D9GMH	Micron	-	-	-
1G	Transcend	505649-1993	DS	5	7HD22D9GMH	Micron	-	-	-
1G	Transcend	TS128MLQ64V8J	DS	5	TQ123PJF8F0801	Transcend	-	-	-
1G	Transcend	JM800QLU-1G	SS	5	TQ1243PCF8	Transcend	-	-	-
1G	Transcend	TS128MLQ64V8U	SS	5	E1108ACBG-8E-E	Elpida	-	-	-
2G	Transcend	JM800QLU-2G	DS	5	TQ243PCF8	Transcend	-	-	-
2G	Transcend	TS256MLQ64V8U	DS	5	E1108ACBG-8E-E	Elpida	-	-	-
1G	ADATA	M2OAD6G314170Q1E58	DS	N/A	AD29608A8A-25EG80810	ADATA	-	-	-
512MB	VDATA	M2GVD6G3H3160Q1E52	SS	N/A	VD29608A8A-25EG20813	VDATA	-	-	-

(continued on the next page)



## DDR2-800MHz capability

Size	Vendor	Part No.	SS/DS	CL	Chip No.	Chip Brand	DIMM support		
							A*	B*	C*
2G	PSC	AL8E8F73C-8E1	DS	5	A3R1GE3CFF734MAAOE	PSC	-	-	-
2G	PSC	PL8E8F73C-8E1	DS	5	SHG772-AA3G	PSC	-	-	-
2G	PSC	PL8E8G73E-8E1	DS	5	XCP271A3G-A	PSC	-	-	-
2G	PSC	AL7E8E63H-10E1K	DS	5	A3R1GE3CFF750RABBP(ECC)	PSC	-	-	-
1G	GEIL	GB22GB6400C4DC	DS	4	GL2L64M088BA30EB	GEIL	-	-	-
1G	GEIL	GB24GB6400C4QC	DS	4	GL2L64M088BA30EB	GEIL	-	-	-
1G	GEIL	GB22GB6400C5DC	DS	5	GL2L64M088BA30EB	GEIL	-	-	-
1G	GEIL	GB24GB6400C5QC	DS	5	GL2L64M088BA30EB	GEIL	-	-	-
1G	GEIL	GX22GB6400DC	DS	5	Heat-Sink Package	GEIL	-	-	-
1G	GEIL	GE22GB800C4DC	DS	4	Heat-Sink Package	GEIL	-	-	-
1G	GEIL	GE24GB800C4QC	DS	4	Heat-Sink Package	GEIL	-	-	-
1G	GEIL	GX22GB6400UDC	DS	4	Heat-Sink Package	GEIL	-	-	-
1G	GEIL	GE22GB800C5DC	DS	5	Heat-Sink Package	GEIL	-	-	-
2G	GEIL	GB24GB6400C5DC	DS	5	GL2L128M88BA25AB	GEIL	-	-	-
2G	GEIL	GB28GB6400C5QC	DS	5	GL2L128M88BA25AB	GEIL	-	-	-
2G	GEIL	GX24GB6400DC	DS	5	Heat-Sink Package	GEIL	-	-	-
2G	GEIL	GE28GB800C5QC	DS	5	Heat-Sink Package	GEIL	-	-	-
2G	GEIL	GE28GB800C4QC	DS	4	Heat-Sink Package	GEIL	-	-	-
2G	GEIL	GE24GB800C4DC	DS	4	Heat-Sink Package	GEIL	-	-	-
2G	GEIL	GE24GB800C5DC	DS	5	Heat-Sink Package	GEIL	-	-	-
1G	G.SKILL	F2-6400CL4D-2GBPK	DS	4	Heat-Sink Package	G.SKILL	-	-	-
1G	G.SKILL	F2-6400CL4D-2GBHK	DS	4	Heat-Sink Package	G.SKILL	-	-	-
2G	G.SKILL	F2-6400CL5D-4GBPQ	DS	5	Heat-Sink Package	G.SKILL	-	-	-
2G	G.SKILL	F2-6400CL4D-4GBPK	DS	4	Heat-Sink Package	G.SKILL	-	-	-
4G	G.SKILL	F2-6400CL5Q-16GNQ	DS	5	Heat-Sink Package	G.SKILL	-	-	-
1G(Kit of 2)	G.SKILL	F2-6400CL5D-1GBNQ	SS	5-5-5-15	Heat-Sink Package	G.SKILL	-	-	-
1G	OCZ	OCZ2RPR8002GK	DS	4	Heat-Sink Package	OCZ	-	-	-
1G	OCZ	OCZ2G800R22GK	DS	5	Heat-Sink Package	OCZ	-	-	-
1G	OCZ	OCZ2P800R22GK	DS	4	Heat-Sink Package	OCZ	-	-	-
1G	OCZ	OCZ2VU8004GK	DS	6	Heat-Sink Package	OCZ	-	-	-
2G	OCZ	OCZ2P8004GK	DS	5	Heat-Sink Package	OCZ	-	-	-
1G	Elixir	M2Y1G64TU8HB0B-25C	DS	5	N2TU51280BE-25C802006Z1DV	Elixir	-	-	-
1G	Elixir	M2Y1G64TU88D5B-AC0828.GS	SS	5	N2TU16800E-AC	Elixir	-	-	-
2G	Elixir	M2Y2G64TU8HD5B-AC0826.SG	DS	5	N2TUG80DE-AC	Elixir	-	-	-

## DDR2-1066MHz capability

Size	Vendor	Part No.	SS/ DS	CL	Chip No.	Chip Brand	DIMM support	
							A*	B*
512MB	Kingston	KHX8500D2/512	SS	N/A	Heat-Sink Package	Kingston	-	-
512MB	Kingston	KVR1066D2N7/512	SS	N/A	E5108AJBG-1J-E	Elpida	-	-
512MB	Kingston	KHX8500D2K2/1GN	SS	N/A	Heat-Sink Package	Kingston	-	-
1G	Kingston	KHX8500D2K2/2GN	DS	N/A	Heat-Sink Package	Kingston	-	-
1G	Kingston	KVR1066D2N7/1G	DS	N/A	E5108AJBG-1J-E	Elpida	-	-
1G	Kingston	KHX8500D2/1G	DS	N/A	Heat-Sink Package	Kingston	-	-
1G	Qimonda	HYS64T128020EU-19F-C	DS	6	HYB18T512800CF19FFSS24313	Qimonda	-	-
1G	Kingmax	KLED48F-A8K15	DS	N/A	KKA8FFIXF-JFS-18A	Kingmax	-	-
1G	Crucial	BL12864AA1065.8FE5	SS	5-5-5-15	Heat-Sink Package	N/A	-	-
1G	Transcend	TX1066QLJ-2GK1GB	DS	5	Heat-Sink Package	Transcend	-	-
2G(kit of 2)	Transcend	TX1066QLU-2GK	SS	5	Heat-Sink Package	Transcend	-	-
2G	Transcend	TX1066QLU-4GK	DS	5	Heat-Sink Package	Transcend	-	-
1G	OCZ	OCZ2N10662GK	DS	N/A	Heat-Sink Package	OCZ	-	-
1G	GEIL	GB22GB8500C5DC	SS	5	GL2L128M88BA25AB	GEIL	-	-
1G	GEIL	GB24GB8500C5QC	SS	5	GL2L128M88BA25AB	GEIL	-	-
1G	GEIL	GE22GB1066C5DC	SS	5	Heat-Sink Package	GEIL	-	-
1G	GEIL	GE24GB1066C5QC	SS	5	Heat-Sink Package	GEIL	-	-
2G(kit of 2)	G.SKILL	F2-8500CL5D-2GBPK	DS	5-5-5-15	Heat-Sink Package	N/A	-	-
1G	G.SKILL	F2-8500CL5S-1GBPK	DS	5-5-5-15	Heat-Sink Package	G.SKILL	-	-

## DDR2-1200(O.C.)MHz capability

Size	Vendor	Part No.	SS/ DS	CL	Chip NO.	Chip Brand	DIMM support	
							A*	B*
2G(Kit of 2)	Kingston	KHX96002K2/2G	DS	5-5-5-15	Heat-Sink Package	N/A	*	*
2G(Kit of 2)	OCZ	OCZ2FX12002GK	DS	5-5-5-18	Heat-Sink Package	N/A	*	*
2G(Kit of 2)	Team	TXDD1024M1300HC6	DS	6-6-6-18	Heat-Sink Package	Heat-Sink Package	*	*



- Due to AM2+/AM3 CPU limitation, only one DDR2 1200(O.C.)/1066 DIMM is supported per channel. When four DDR2 1200(O.C.)/1066 DIMMs are installed, all DIMMs run at 800MHz frequency by default for system stability.
- The default DIMM frequency depends on its Serial Presence Detect (SPD), which is the standard way of accessing information from a memory module. Under the default state, some memory modules for overclocking may operate at a lower frequency than the vendor-marked value.



### SS: Single-sided / DS: Double-sided DIMM support:

- **A\***: Supports one module inserted into any slot as single-channel memory configuration.
- **B\***: Supports one pair of modules inserted into either the blue slots or the black slots as one pair of dual-channel memory configuration.
- **C\***: Supports two pairs of modules inserted into both the blue slots and the black slots as two pairs of dual-channel memory configuration.



Visit the ASUS website at [www.asus.com](http://www.asus.com) for the latest QVL.

### 1.7.3 Installing a DIMM



Unplug the power supply before adding or removing DIMMs or other system components. Failure to do so can cause severe damage to both the motherboard and the components.

1. Press the retaining clips outward to unlock a DIMM socket.
2. Align a DIMM on the socket such that the notch on the DIMM matches the break on the socket.

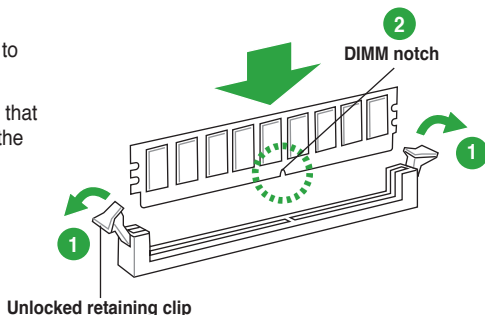

A DIMM is keyed with a notch so that it fits in only one direction. DO NOT force a DIMM into a socket to avoid damaging the DIMM.

3. Firmly insert the DIMM into the socket until the retaining clips snap back in place and the DIMM is properly seated.

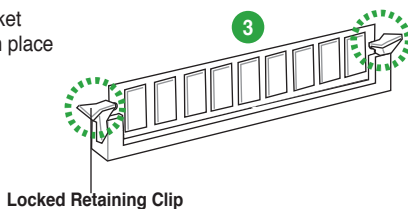

### 1.7.4 Removing a DIMM

To remove a DIMM:

1. Simultaneously press the retaining clips outward to unlock the DIMM.



Support the DIMM lightly with your fingers when pressing the retaining clips. The DIMM might get damaged when it flips out with extra force.

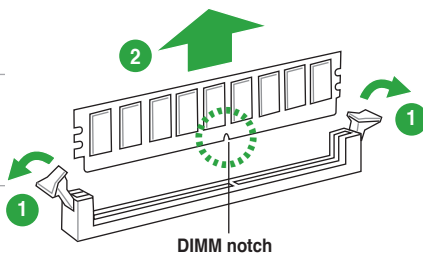

2. Remove the DIMM from the socket.

## 1.8 Expansion slots

In the future, you may need to install expansion cards. The following sub-sections describe the slots and the expansion cards that they support.



---

Unplug the power cord before adding or removing expansion cards. Failure to do so may cause you physical injury and damage motherboard components.

---

### 1.8.1 Installing an expansion card

To install an expansion card:

1. Before installing the expansion card, read the documentation that came with it and make the necessary hardware settings for the card.
2. Remove the system unit cover (if your motherboard is already installed in a chassis).
3. Remove the bracket opposite the slot that you intend to use. Keep the screw for later use.
4. Align the card connector with the slot and press firmly until the card is completely seated on the slot.
5. Secure the card to the chassis with the screw you removed earlier.
6. Replace the system cover.

### 1.8.2 Configuring an expansion card

After installing the expansion card, configure it by adjusting the software settings.

1. Turn on the system and change the necessary BIOS settings, if any. See Chapter 2 for information on BIOS setup.
2. Assign an IRQ to the card.
3. Install the software drivers for the expansion card.



---

When using PCI cards on shared slots, ensure that the drivers support "Share IRQ" or that the cards do not need IRQ assignments. Otherwise, conflicts will arise between the two PCI groups, making the system unstable and the card inoperable.

---

### 1.8.3 PCI slots

The PCI slots support cards such as a LAN card, SCSI card, USB card, and other cards that comply with PCI specifications.

### 1.8.4 PCI Express x1 slots

This motherboard supports PCI Express x1 network cards, SCSI cards, and other cards that comply with the PCI Express specifications.

### 1.8.5 PCI Express x16 slot

This motherboard supports a PCI Express x16 graphics card that complies with the PCI Express specifications.

## 1.9 Jumpers

### 1. Clear RTC RAM (CLRRTC)

This jumper allows you to clear the Real Time Clock (RTC) RAM in CMOS. You can clear the CMOS memory of date, time, and system setup parameters by erasing the CMOS RTC RAM data. The onboard button cell battery powers the RAM data in CMOS, which include system setup information such as system passwords.

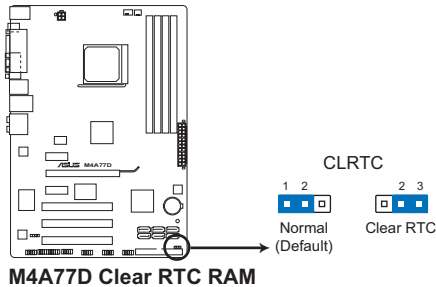

To erase the RTC RAM:

1. Turn OFF the computer and unplug the power cord.
2. Move the jumper cap from pins 1-2 (default) to pins 2-3. Keep the cap on pins 2-3 for about 5~10 seconds, then move the cap back to pins 1-2.
3. Plug the power cord and turn ON the computer.
4. Hold down the <Del> key during the boot process and enter BIOS setup to reenter data.



---

Except when clearing the RTC RAM, never remove the cap on CLRRTC jumper default position. Removing the cap will cause system boot failure!

---



- If the steps above do not help, remove the onboard battery and move the jumper again to clear the CMOS RTC RAM data. After clearing the CMOS, reinstall the battery.
  - You do not need to clear the RTC when the system hangs due to overclocking. For system failure due to overclocking, use the CPU Parameter Recall (C.P.R) feature. Shut down and reboot the system so the BIOS can automatically reset parameter settings to default values.
-

# 1.10 Connectors

## 1.10.1 Rear panel ports

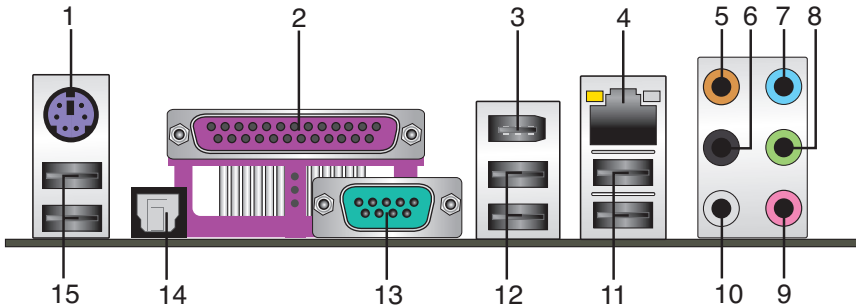

1. **PS/2 Keyboard port (purple).** This port is for a PS/2 keyboard.
2. **Parallel port.** This 25-pin port connects a parallel printer, a scanner, or other devices.
3. **IEEE 1394a port.** This 6-pin IEEE 1394a port provides high-speed connectivity for audio/video devices, storage peripherals, PCs, or portable devices.
4. **LAN (RJ-45) port.** This port allows Gigabit connection to a Local Area Network (LAN) through a network hub.

### LAN port LED indications

Activity/Link LED		Speed LED	
Status	Description	Status	Description
OFF	No link	OFF	10Mbps connection
ORANGE	Linked	ORANGE	100Mbps connection
BLINKING	Data activity	GREEN	1Gbps connection

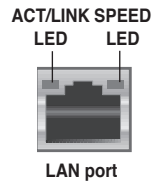

5. **Center/Subwoofer port (orange).** This port connects to the center/subwoofer speakers.
6. **Rear Speaker Out port (black).** This port connects to the rear speakers in the 4, 6, and 8-channel audio configurations.
7. **Line In port (light blue).** This port connects to the tape, CD, DVD player, or other audio sources.
8. **Line Out port (lime).** This port connects to a headphone or a speaker. In the 4, 6 and 8-channel configurations, the function of this port becomes Front Speaker Out.
9. **Microphone port (pink).** This port connects to a microphone.
10. **Side Speaker Out port (gray).** This port connects to the side speakers in the 8-channel audio configuration.



Refer to the audio configuration table below for the function of the audio ports in the 2, 4, 6, or 8-channel configuration.

### Audio 2, 4, 6, or 8-channel configuration

Port	Headset 2-channel	4-channel	6-channel	8-channel
Light Blue	Line In	Line In	Line In	Line In
Lime	Line Out	Front Speaker Out	Front Speaker Out	Front Speaker Out
Pink	Mic In	Mic In	Mic In	Mic In
Orange	–	–	Center/Subwoofer	Center/Subwoofer
Black	–	Rear Speaker Out	Rear Speaker Out	Rear Speaker Out
Gray	–	–	–	Side Speaker Out



Ensure the audio device of sound playback is **VIA High Definition Audio** (the name may be different based on the OS). Go to **Start > Control Panel > Sounds and Audio Devices > Sound Playback** to configure the settings.

- 11. USB 2.0 ports 1 and 2.** These two 4-pin Universal Serial Bus (USB) ports are for USB 2.0 devices.
- 12. USB 2.0 ports 3 and 4.** These two 4-pin Universal Serial Bus (USB) ports are for USB 2.0 devices.
- 13. Serial port.** This 9-pin COM1 port is for pointing devices or other serial devices.
- 14. Optical S/PDIF\_OUT port.** This port connects to an external audio output device via an optical S/PDIF cable.
- 15. USB 2.0 ports 5 and 6.** These two 4-pin Universal Serial Bus (USB) ports are available for connecting USB 2.0 devices.

## 1.10.2 Internal connectors

### 1. ATX power connectors (24-pin EATXPWR, 4-pin ATX12V)

These connectors are for an ATX power supply. The plugs from the power supply are designed to fit these connectors in only one orientation. Find the proper orientation and push down firmly until the connectors completely fit.

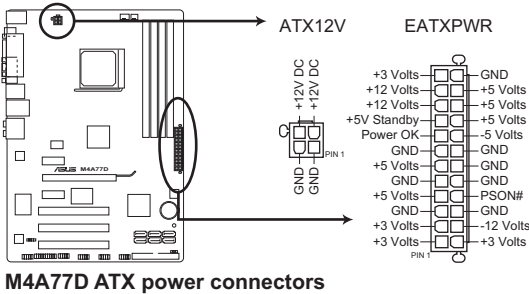

- We recommend that you use an ATX 12V Specification 2.0-compliant power supply unit (PSU) with a minimum of 300W power rating. This PSU type has 24-pin and 4-pin power plugs.
- If you intend to use a PSU with 20-pin and 4-pin power plugs, ensure that the 20-pin power plug can provide at least 15 A on +12 V and that the PSU has a minimum power rating of 300W. The system may become unstable or may not boot up if the power is inadequate.
- DO NOT forget to connect the 4-pin ATX +12V power plug. Otherwise, the system will not boot up.
- We recommend that you use a PSU with higher power output when configuring a system with more power-consuming devices or when you intend to install additional devices. The system may become unstable or may not boot up if the power is inadequate.
- If you are uncertain about the minimum power supply requirement for your system, refer to the Recommended Power Supply Wattage Calculator at <http://support.asus.com/PowerSupplyCalculator/PSCalculator.aspx?SLanguage=en-us> for details.



## 2. IDE connector (40-1 pin PRI\_IDE)

The onboard IDE connector is for Ultra DMA 133/100 signal cable. There are three connectors on each Ultra DMA 133/100 signal cable: blue, black, and gray. Connect the blue connector to the motherboard's IDE connector, then select one of the following modes to configure your devices:

	Drive jumper setting	Mode of device(s)	Cable connector
Single device	Cable-Select or Master	-	Black
Two devices	Cable-Select	Master	Black
		Slave	Gray
	Master	Master	Black or gray
		Slave	



- Pin 20 on the IDE connector is removed to match the covered hole on the Ultra DMA cable connector. This prevents incorrect insertion when you connect the IDE cable.
- Use the 80-conductor IDE cable for Ultra DMA 133/100 IDE devices.



If any device jumper is set as "Cable-Select", ensure that all other device jumpers have the same setting.

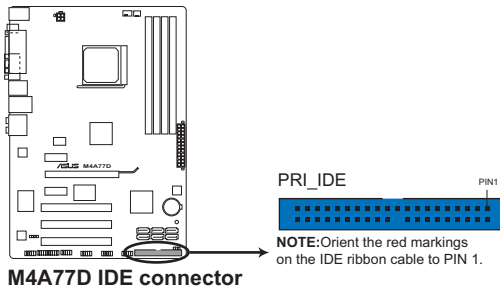

### 3. Serial ATA connectors (7-pin SATA1, SATA2, SATA3, SATA4, SATA5, SATA6)

These connectors are for the Serial ATA signal cables for Serial ATA 3Gb/s hard disk and optical disk drives. The Serial ATA 3Gb/s is backward compatible with Serial ATA 1.5Gb/s specification. The data transfer rate of the Serial ATA 3Gb/s is faster than the standard parallel ATA with 133 MB/s (Ultra DMA133). If you install Serial ATA hard disk drives, you can create RAID 0, RAID 1, and RAID 0+1 configurations through the onboard SB710 chipset.

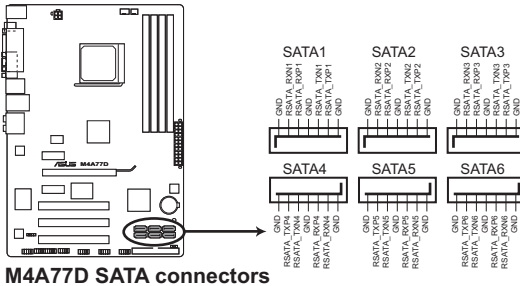

**M4A77D SATA connectors**



- Install the Windows® XP Service Pack 2 or later versions before using Serial ATA.
- If you intend to create a Serial ATA RAID set using these connectors, set the type of the SATA connectors in the BIOS to **[RAID]**. See section **2.3.4 SATA Configuration** for details.
- The motherboard does not provide a floppy disk drive connector. You could use a USB floppy disk drive when installing Windows® XP operating system on a hard disk drive that includes a RAID/AHCI set.
- Due to Windows® XP limitation, Windows® XP may not recognize the USB floppy disk drive.
- For more details on RAID/AHCI, refer to the RAID/AHCI Supplementary Guide included in the folder named Manual in the support DVD.

#### 4. System panel connector (20-pin PANEL)

This connector supports several chassis-mounted functions.

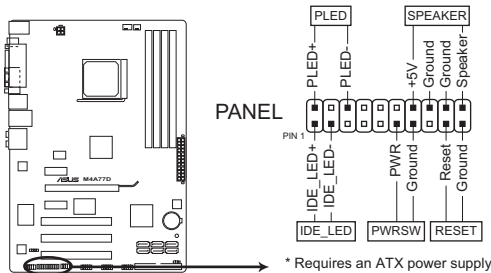

#### M4A77D System panel connector

- **System power LED (2-pin PLED)**

This 2-pin connector is for the system power LED. Connect the chassis power LED cable to this connector. The system power LED lights up when you turn on the system power, and blinks when the system is in sleep mode.

- **Hard disk drive activity LED (2-pin IDE\_LED)**

This 2-pin connector is for the HDD Activity LED. Connect the HDD Activity LED cable to this connector. The IDE LED lights up or flashes when data is read from or written to the HDD.

- **System warning speaker (4-pin SPEAKER)**

This 4-pin connector is for the chassis-mounted system warning speaker. The speaker allows you to hear system beeps and warnings.

- **ATX power button/soft-off button (2-pin PWRSW)**

This connector is for the system power button. Pressing the power button turns the system on or puts the system in sleep or soft-off mode depending on the BIOS settings. Pressing the power switch for more than four seconds while the system is ON turns the system OFF.

- **Reset button (2-pin RESET)**

This 2-pin connector is for the chassis-mounted reset button for system reboot without turning off the system power.

**5. USB connectors (10-1 pin USB78, USB910, USB1112)**

These connectors are for USB 2.0 ports. Connect the USB module cable to any of these connectors, then install the module to a slot opening at the back of the system chassis. These USB connectors comply with USB 2.0 specification that supports up to 480Mbps connection speed.

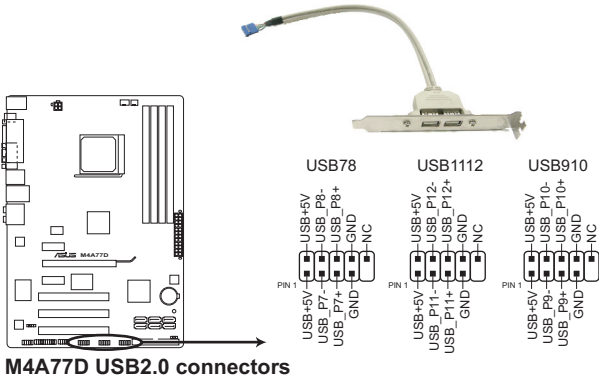

Never connect a 1394 cable to the USB connectors. Doing so will damage the motherboard!



The USB 2.0 module is purchased separately.

## 6. Digital audio connector (4-1 pin SPDIF\_OUT)

This connector is for an additional Sony/Philips Digital Interface (S/PDIF) port.

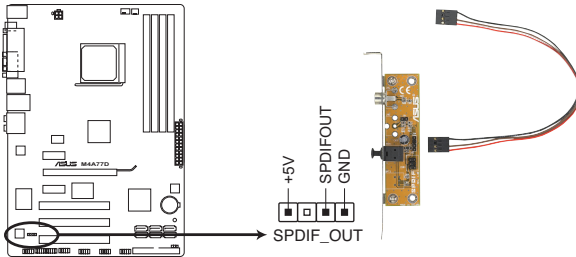

### M4A77D Digital audio connector



Ensure that the audio device of Sound playback is **VIA High Definition Audio** (the name may be different based on the OS). Go to **Start > Control Panel > Sounds and Audio Devices > Sound Playback** to configure the setting.



The S/PDIF module is purchased separately.

## 7. Front panel audio connector (10-1 pin AAFP)

This connector is for a chassis-mounted front panel audio I/O module that supports either High Definition Audio or AC'97 audio standard. Connect one end of the front panel audio I/O module cable to this connector.

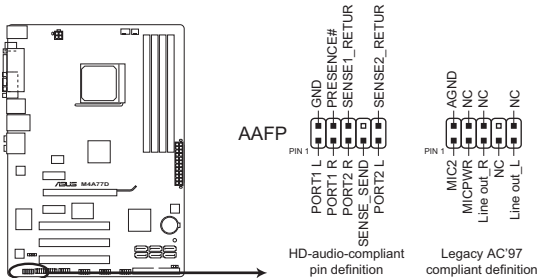

### M4A77D Analog front panel connector



- We recommend that you connect a high-definition front panel audio module to this connector to avail of the motherboard high-definition audio capability.
- If you want to connect a high definition front panel audio module to this connector, set the **Front Panel Select** item in the BIOS to **[HD Audio]**. See section 2.4.4 **Onboard Device Configuration** for details.
- The front panel audio I/O module is purchased separately.

## 8. CPU and chassis fan connectors (4-pin CPU\_FAN, 3-pin CHA\_FAN)

Connect the fan cables to the fan connectors on the motherboard, ensuring that the black wire of each cable matches the ground pin of the connector.

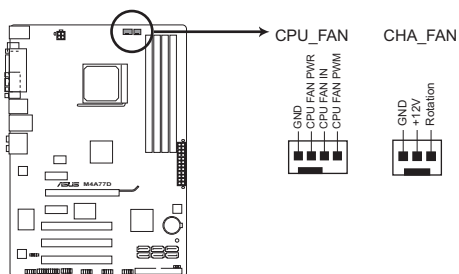

**M4A77D fan connectors**



DO NOT forget to connect the fan cables to the fan connectors. Insufficient air flow inside the system may damage the motherboard components. These are not jumpers! DO NOT place jumper caps on the fan connectors.



Only the 4-pin CPU fan supports the ASUS Q-Fan feature.

## 9. IEEE 1394a connector (10-1 pin IE1394\_1)

This connector is for an IEEE 1394a port. Connect the IEEE 1394a module cable to this connector, then install the module to a slot opening at the back of the system chassis.

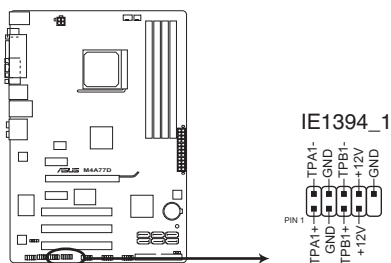

**M4A77D IEEE 1394a Connector**



Never connect a USB cable to the IEEE 1394a connector. Doing so will damage the motherboard!



The IEEE 1394a module is purchased separately.

## 1.11 Software support

### 1.11.1 Installing an operating system

This motherboard supports Windows® XP / Vista / 7 Operating Systems (OS). Always install the latest OS version and corresponding updates to maximize the features of your hardware.



- Motherboard settings and hardware options vary. Refer to your OS documentation for detailed information.
- Ensure that you install Windows® XP Service Pack 3 or later versions / Windows® Vista Service Pack 1 or later versions before installing the drivers for better compatibility and system stability.

### 1.11.2 Support DVD information

The Support DVD that comes with the motherboard package contains the drivers, software applications, and utilities that you can install to avail all motherboard features.



The contents of the Support DVD are subject to change at any time without notice. Visit the ASUS website at [www.asus.com](http://www.asus.com) for updates.

### To run the Support DVD

Place the Support DVD into the optical drive. The DVD automatically displays the Drivers menu if Autorun is enabled on your computer.



The following screen is for reference only.

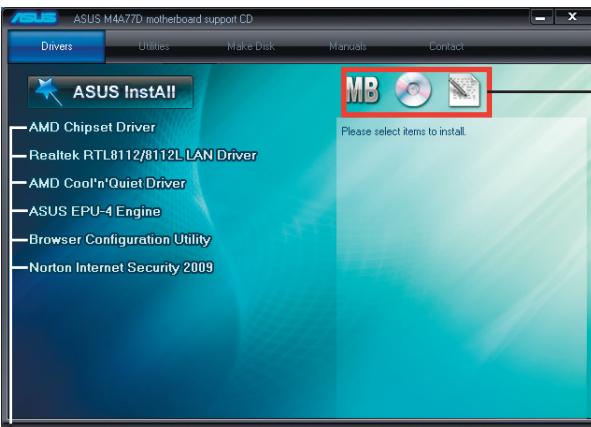

Click an icon to display Support DVD/ motherboard information

Click an item to install



If Autorun is NOT enabled on your computer, browse the contents of the Support DVD to locate the file ASSETUP.EXE from the BIN folder. Double-click the ASSETUP.EXE to run the DVD.





# Chapter 2

## BIOS information

### 2.1 Managing and updating your BIOS



---

Save a copy of the original motherboard BIOS file to a USB flash disk in case you need to restore the BIOS in the future. Copy the original motherboard BIOS using the ASUS Update utility.

---

#### 2.1.1 ASUS Update utility

The ASUS Update is a utility that allows you to manage, save, and update the motherboard BIOS in Windows® environment.



- ASUS Update requires an Internet connection either through a network or an Internet Service Provider (ISP).
  - This utility is available in the support DVD that comes with the motherboard package.
- 

#### Installing ASUS Update

To install ASUS Update:

1. Place the support DVD into the optical drive. The **Drivers** menu appears.
2. Click the **Utilities** tab, then click **ASUS Update**.
3. Follow the onscreen instructions to complete the installation.



---

Quit all Windows® applications before you update the BIOS using this utility.

---

#### Updating the BIOS

To update the BIOS:

1. From the Windows® desktop, click **Start > Programs > ASUS > ASUS Update > ASUS Update** to launch the ASUS Update utility.
2. From the dropdown list, select either of the following methods:

##### *Updating from the Internet*

- a. Select **Update BIOS from the Internet**, then click **Next**.
- b. Select the ASUS FTP site nearest you to avoid network traffic, or click **Auto Select** then click **Next**.
- c. From the FTP site, select the BIOS version that you want to download then click **Next**.



The ASUS Update utility is capable of updating itself through the Internet. Always update the utility to avail all its features.

#### *Updating from a BIOS file*

- a. Select **Update BIOS from a file**, then click **Next**.
  - b. Locate the BIOS file from the **Open** window, then click **Open**.
3. Follow the onscreen instructions to complete the updating process.

## 2.1.2 ASUS EZ Flash 2

The ASUS EZ Flash 2 feature allows you to update the BIOS without using an OS-based utility.



Before you start using this utility, download the latest BIOS file from the ASUS website at [www.asus.com](http://www.asus.com).

To update the BIOS using EZ Flash 2:

1. Insert the USB flash disk that contains the latest BIOS file to the USB port, then launch EZ Flash 2 in either of these two ways:
  - Press **<Alt> + <F2>** during POST.
  - Enter the BIOS setup program. Go to the **Tools** menu to select **EZ Flash 2** and press **<Enter>** to enable it.Press **<Tab>** to switch between drives until the correct BIOS file is found.

```
ASUSTek EZ Flash 2 BIOS ROM Utility V3.36
FLASH TYPE: MXIC 25L8005
----- Current ROM ----- Update ROM -----
BOARD: M4A77D                BOARD: Unknown
VER: 0401 (H:02 B:07)        VER: Unknown
DATE: 10/12/2009            DATE: Unknown
PATH: C:\
C:
Note
[Enter] Select or Load [Tab] Switch [V] Drive Info
[Up/Down/Home/End] Move [B] Backup [ESC] Exit
```

2. When the correct BIOS file is found, EZ Flash 2 performs the BIOS update process and automatically reboots the system when done.



- 
- This function supports USB flash disks with **FAT 32/16** format and single partition only.
  - **DO NOT** shut down or reset the system while updating the BIOS to prevent system boot failure!
- 

### 2.1.3 ASUS CrashFree BIOS

The ASUS CrashFree BIOS is an auto recovery tool that allows you to restore the BIOS file when it fails or gets corrupted during the updating process. You can restore a corrupted BIOS file using the motherboard support DVD or a removable device that contains the updated BIOS file.



- 
- Before using this utility, rename the BIOS file in the removable device into **M4A77D.ROM**.
  - The BIOS file in the support DVD may not be the latest version. Download the latest BIOS file from the ASUS website at [www.asus.com](http://www.asus.com).
  - The removable devices that ASUS CrashFree BIOS support vary with motherboard models. For motherboards without the floppy connector, prepare a USB flash disk before using this utility.
- 

### Recovering the BIOS

To recover the BIOS:

1. Turn on the system.
2. Insert the support DVD to the optical drive or the removable device that contains the BIOS file to the USB port or to the floppy disk drive, if supported.
3. The utility automatically checks the devices for the BIOS file. When found, the utility reads the BIOS file and starts flashing the corrupted BIOS file.
4. Turn off the system after the utility completes the updating process and turn on again.



---

**DO NOT** shut down or reset the system while updating the BIOS! Doing so can cause system boot failure!

---



---

Ensure to load the BIOS default settings to ensure system compatibility and stability. Select the **Load Setup Defaults** item under the Exit menu. Refer to section **2.8 Exit menu** for details.

---

## 2.2 BIOS setup program

Use the BIOS Setup program to update the BIOS or configure its parameters. The BIOS screens include navigation keys and brief online help to guide you in using the BIOS Setup program.

### Entering BIOS Setup at startup

To enter BIOS Setup at startup:

- Press <Delete> during the Power-On Self Test (POST). If you do not press <Delete>, POST continues with its routines.

### Entering BIOS Setup after POST

To enter BIOS Setup after POST:

- Press <Ctrl>+<Alt>+<Del> simultaneously.
- Press the reset button on the system chassis.
- Press the power button to turn the system off then back on. Do this option only if you failed to enter BIOS Setup using the first two options.



Using the **power button**, **reset button**, or the <Ctrl>+<Alt>+<Del> keys to force reset from a running operating system can cause damage to your data or system. We recommend that you always shut down the system properly from the operating system.

---



- The default BIOS settings for this motherboard apply to most conditions to ensure optimum performance. If the system becomes unstable after changing any BIOS settings, load the default settings to ensure system compatibility and stability. Select the **Load Setup Defaults** item under the **Exit** menu. See section **2.8 Exit Menu**.
  - The BIOS setup screens in this chapter are for reference only. They may not exactly match what you see on your screen.
  - Visit the ASUS website at [www.asus.com](http://www.asus.com) to download the latest BIOS file for this motherboard.
-

## 2.2.1 BIOS menu screen

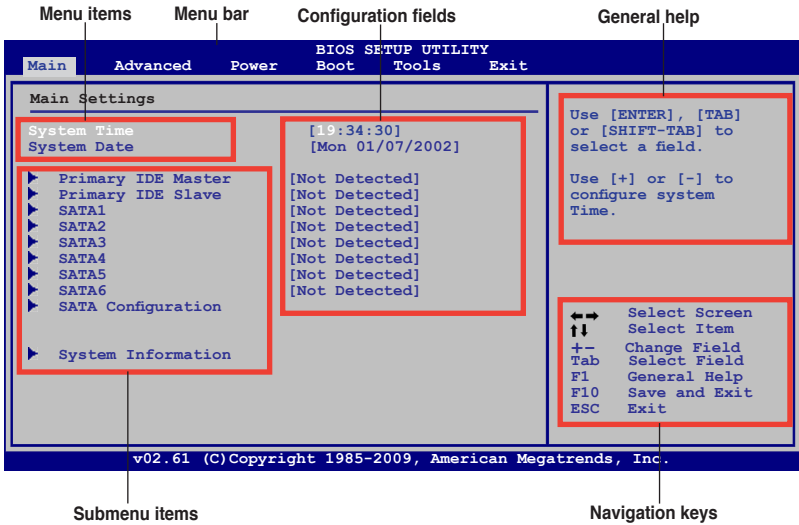

### 2.2.2 Menu bar

The menu bar on top of the screen has the following main items:

- Main**      For changing the basic system configuration
- Advanced**      For changing the advanced system settings
- Power**      For changing the advanced power management (APM) configuration
- Boot**      For changing the system boot configuration
- Tools**      For configuring options for special functions
- Exit**      For selecting the exit options and loading default settings.

To select an item on the menu bar, press the right or left arrow key on the keyboard until the desired item is highlighted.

### 2.2.3 Navigation keys

At the bottom right corner of a menu screen are the navigation keys for that particular menu. Use the navigation keys to select items in the menu and change the settings.



Some of the navigation keys differ from one screen to another.

## 2.2.4 Menu items

The highlighted item on the menu bar displays the specific items for that menu. For example, selecting Main shows the Main menu items.

The other items (Advanced, Power, Boot, Tools, and Exit) on the menu bar have their respective menu items.

## 2.2.5 Submenu items

A solid triangle before each item on a menu screen means that the item has a submenu. To display the submenu, select the item and press **<Enter>**.

## 2.2.6 Configuration fields

These fields show the values for the menu items. If an item is user-configurable, you can change the value of the field opposite the item. You cannot select an item that is not user-configurable.

A configurable field is enclosed in brackets, and is highlighted when selected. To change the value of a field, select it then press **<Enter>** to display a list of options. Refer to **2.2.7 Pop-up window**.

## 2.2.7 Pop-up window

Select a menu item then press **<Enter>** to display a pop-up window with the configuration options for that item.

## 2.2.8 Scroll bar

A scroll bar appears on the right side of a menu screen when there are items that do not fit on the screen. Press the **<Up>** / **<Down>** arrow keys or **<Page Up>** / **<Page Down>** keys to display the other items on the screen.

## 2.2.9 General help

At the top right corner of the menu screen is a brief description of the selected item.

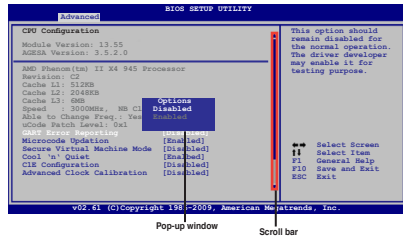

## 2.3 Main menu

When you enter the BIOS Setup program, the Main menu screen appears, giving you an overview of the basic system information.



Refer to section 2.2.1 **BIOS menu screen** for information on the menu screen items and how to navigate through them.

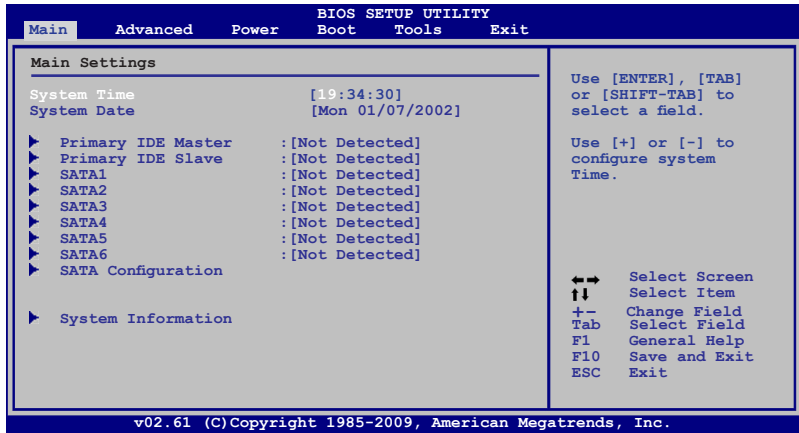

### 2.3.1 System Time [xx:xx:xx]

Allows you to set the system time.

### 2.3.2 System Date [Day xx/xx/xxxx]

Allows you to set the system date.

### 2.3.3 Primary IDE Master/Slave, SATA 1/2/3/4/5/6

While entering Setup, the BIOS automatically detects the presence of IDE/SATA devices. There is a separate submenu for each IDE/SATA device. Select a device item then press **<Enter>** to display the IDE/SATA device information.

The BIOS automatically detects the values opposite the dimmed items (Device, Vendor, Size, LBA Mode, Block Mode, PIO Mode, Async DMA, Ultra DMA, and SMART monitoring). These values are not user-configurable. These items show Not Detected if no IDE/SATA device is installed in the system.

#### Type [Auto]

Selects the type of IDE/SATA drive. Setting this item to **[Auto]** allows automatic selection of the appropriate IDE/SATA device type. Select **[CDROM]** if you are specifically configuring a CD-ROM drive. Select **[ARMD]** (ATAPI Removable Media Device) if your device is either a ZIP, LS-120, or MO drive. Configuration options: [Not Installed] [Auto] [CDROM] [ARMD]



This item only appears in the **Primary IDE Master/Slave** and **SATA5/6** menus.

### LBA/Large Mode [Auto]

Enables or disables the LBA mode. Setting this item to **[Auto]** enables the LBA mode if the device supports this mode, and if the device was not previously formatted with LBA mode disabled. Configuration options: [Disabled] [Auto]

### Block (Multi-Sector Transfer) M [Auto]

Enables or disables data multi-sectors transfers. When this item is set to **[Auto]**, the data transfer from and to the device occurs multiple sectors at a time if the device supports multi-sector transfer feature. When this item is set to **[Disabled]**, the data transfer from and to the device occurs one sector at a time. Configuration options: [Disabled] [Auto]

### PIO Mode [Auto]

Selects the PIO mode. Configuration options: [Auto] [0] [1] [2] [3] [4]

### DMA Mode [Auto]

Selects the DMA mode. Configuration options: [Auto]

### SMART Monitoring [Auto]

Sets the Smart Monitoring, Analysis, and Reporting Technology. Configuration options: [Auto] [Disabled] [Enabled]

### 32Bit Data Transfer [Enabled]

Enables or disables 32-bit data transfer. Configuration options: [Disabled] [Enabled]

## 2.3.4 SATA Configuration

The **SATA Configuration** menu allows you to configure your storage devices. Select an item then press **<Enter>** to display the submenu.

### OnChip SATA Channel [Enabled]

Enables or disables OnChip SATA Channel. Configuration options: [Disabled] [Enabled]



---

The following two items only appear when you set **OnChip SATA Channel** to **[Enabled]**.

---

#### SATA Port1-Port4 [IDE]

Sets the SATA 1~4 type. Configuration options: [IDE] [RAID] [AHCI]



---

When this item is set to [IDE], SATA 5~6 can only be set to [IDE].

---

#### SATA Port5-Port6 [IDE]

Sets the SATA 5~6 type. Configuration options: [IDE] [RAID] [AHCI]



---

When this item is set to [AHCI], SATA 5~6 can only be used under OS with AHCI driver installed. Sets this item to [IDE] to use SATA 5~6 before entering OS.

---



## 2.3.5 System Information

This menu gives you an overview of the general system specifications. The BIOS automatically detects the items in this menu.

### BIOS Information

Displays the auto-detected BIOS information.

### Processor

Displays the auto-detected CPU specification.

### System Memory

Displays the auto-detected system memory.

## 2.4 Advanced menu

The **Advanced** menu items allow you to change the settings for the CPU and other system devices.



Take caution when changing the settings of the Advanced menu items. Incorrect field values can cause the system to malfunction.

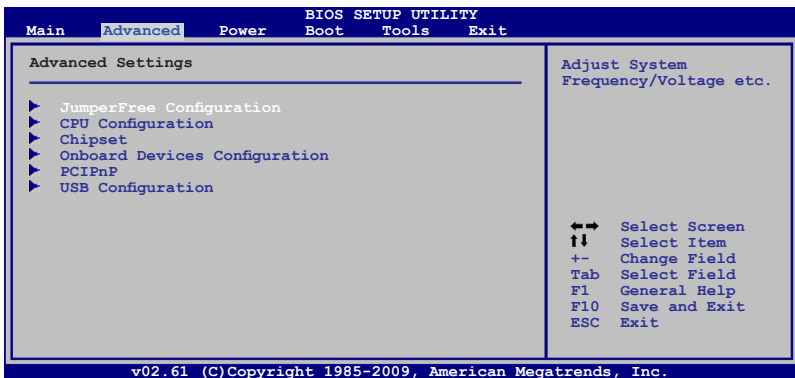

### 2.4.1 JumperFree Configuration



The items and configuration options in this menu may vary depending on the AMD CPU type.

#### CPU Overclocking [Auto]

Selects the CPU overclocking options to achieve desired CPU internal frequency. Configuration options: [Manual] [Auto] [Overclock Profile] [Test Mode]



---

The following item only appears when you set **CPU Overclocking** to **[Manual]**.

---

*CPU/HT Reference Clock (MHz) [200]*

Sets the CPU/HT Reference Clock. Configuration options: [Min.=200] [Max.=550]



---

The following item only appears when you set **CPU Overclocking** to **[Overclock Profile]**.

---

*Overclock Options [Auto]*

Selects the overclocking profile. Configuration options: [Auto] [Overclock 2%]  
[Overclock 5%] [Overclock 8%] [Overclock 10%]

## **PCIe Overclocking [Auto]**

Sets the PCIe overclocking. Configuration options: [Auto] [Manual]



---

The following item only appears when you set **PCIe Overclocking** to **[Manual]**.

---

*PCIe Clock [100]*

Sets the PCIe Clock. Configuration options: [Min.=100] [Max.=150]

## **Processor Frequency Multiplier [Auto]**

Sets the processor frequency multiplier. Configuration options: [Auto] [x8.0 1600MHz]  
[x8.5 1700MHz] ~ [x34.5 6900MHz] [x35.0 7000MHz]

## **CPU/NB Frequency [Auto]**

Sets the CPU/NorthBridge frequency. Configuration options: [Auto] [x4.0 800MHz]  
[x5.0 1000MHz] [x6.0 1200MHz] ~ [x18.0 3600MHz] [x19.0 3800MHz] [x20.0 4000MHz]

## **CPU Over Voltage [Auto]**

Sets the CPU over voltage. The valid value ranges vary depending on your CPU model. Use <+> / <-> keys to adjust the value. Configuration options: [Auto]

## **VDDNB Over Voltage [Auto]**

Sets the VDDNB over voltage. The valid value ranges vary depending on your CPU model. Use <+> / <-> keys to adjust the value. Configuration options: [Auto]

## **CPU VDDA Voltage [Auto]**

Sets the CPU VDDA voltage. Use <+> / <-> keys to adjust the value. Configuration options: [Auto] [Min.=2.5V] [Max.=2.8V]

## **LoadLine Calibration [Auto]**

Sets the LoadLine. The values range from 0% to 100% with a 3.225% increment. Use the <+> / <-> keys to adjust the value. Configuration options: [Auto] [Max. = 100%] [Min. = 0%]

## **HT Link Frequency [Auto]**

Sets the HyperTransport link speed. Configuration options: [Auto] [200MHz] [400MHz]  
[600MHz] [800MHz] [1000MHz] [1200MHz] [1400MHz] [1600MHz] [1800MHz] [2000MHz]  
[2200MHz] [2400MHz] [2600MHz]

## HT Link Width [Auto]

Sets the HyperTransport link width. Configuration options: [Auto] [8 Bit] [16 Bit]

## HT Over Voltage [Auto]

Sets the HyperTransport over voltage. Use <+> / <-> keys to adjust the value.  
Configuration options: [Auto] [Min.=1.20000V] [Max.=1.390000V]

## Memory Clock Mode [Auto]

Sets the memory clock mode. Configuration options: [Auto] [Manual]



---

The following item only appears when you set **Memory Clock Mode** to [Manual].

---

### Memclock Value [200MHz]

Selects the DRAM frequency programming method. Configuration options: [200MHz] [266MHz] [333MHz] [400MHz] [533MHz]

## DRAM Timing Mode [Auto]

Sets the DRAM timing mode. Configuration options: [Auto] [DCT 0] [DCT 1] [Both]



---

The following sub-items appear only when you set the **DRAM Timing Mode** item to [DCT 0], [DCT 1] or [Both].

---

### TCL [Auto]

Configuration options: [Auto] [3 CLK] [4 CLK] [5 CLK] [6 CLK] [7 CLK DH\_Only]

### TRCD [Auto]

Configuration options: [Auto] [3 CLK] [4 CLK] [5 CLK] [6 CLK]

### TRP [Auto]

Configuration options: [Auto] [3 CLK] [4 CLK] [5 CLK] [6 CLK]

### tRTP [Auto]

Configuration options: [Auto] [2-4 CLK] [3-5 CLK]

### TRAS [Auto]

Configuration options: [Auto] [5 CLK] ~ [18 CLK]

### TRC [Auto]

Configuration options: [Auto] [11 CLK] ~ [26 CLK]

### tWR [Auto]

Configuration options: [Auto] [3 CLK] [4 CLK] [5 CLK] [6 CLK]

### TRRD [Auto]

Configuration options: [Auto] [2 CLK] [3 CLK] [4 CLK] [5 CLK]

### tRWTO [Auto]

Configuration options: [Auto] [3 CLK] ~ [17 CLK]

### tWRRD [Auto]

Configuration options: [Auto] [1 CLK] [2 CLK] [3 CLK] [4 CLK]

### tWTR [Auto]

Configuration options: [Auto] [1 CLK] [2 CLK] [3 CLK]

### tWRWR [Auto]

Configuration options: [Auto] [1 CLK] [2 CLK] [3 CLK] [4 CLK]

*tRDRD [Auto]*

Configuration options: [Auto] [3 CLK] [4 CLK] [5 CLK]

*tRFC0/1/2/3 [Auto]*

Configuration options: [Auto] [75ns] [105ns] [127.5ns] [195ns] [327.5ns]

### **Memory Over Voltage [Auto]**

Sets the memory over voltage. The values range from 1.5000V to 2.4450V with a 0.0150V increment. Use the <+> / <-> keys to adjust the value. Configuration options: [Auto] [Max. = 2.4450V] [Min. = 1.5000V]

### **Chipset Over Voltage [Auto]**

Sets the chipset over voltage. Use the <+> / <-> keys to adjust the value. Configuration options: [Auto] [Max. = 1.61000V] [Min. = 1.10000V]

## **2.4.2 CPU Configuration**

The items in this menu show the CPU-related information that the BIOS automatically detects.

### **GART Error Reporting [Disabled]**

This option should remain disabled for the normal operation. The driver developer may enable it for testing purpose. Configuration options: [Disabled] [Enabled]

### **Microcode Updation [Enabled]**

Enables or disables Microcode Updation. Configuration options: [Disabled] [Enabled]

### **Secure Virtual Machine Mode [Disabled]**

Enables or disables Secure Virtual Machine Mode (SVM) Configuration options: [Disabled] [Enabled]

### **Cool 'n' Quiet [Enabled]**

Enables or disables the AMD Cool 'n' Quiet technology. Configuration options: [Enabled] [Disabled]

### **CPU Prefetching [Enabled]**

Enables or disables the CPU prefetching. Configuration options: [Enabled] [Disabled]

### **C1E Configuration [Disabled]**

Enables or disables the CPU Enhanced Halt (C1E) function, a CPU power-saving function in system halt state. When this item is enabled, the CPU core frequency and voltage will be reduced during the system halt state to decrease power consumption.

Configuration options: [Disabled] [Enabled]

### **Advanced Clock Calibration [Disabled]**

Adjusts the processor's overclocking capability. When this item is set to **[Auto]**, the BIOS automatically adjusts this function. When this item is set to **[All Cores]**, the processor has the best overclocking performance. When this item is set to **[Per Core]**, the processor's overclocking capability is enhanced.

Configuration options: [Disabled] [Auto] [All Cores] [Per Core]

## 2.4.3 Chipset

### NorthBridge Configuration

#### Memory Configuration

Bank Interleaving [Auto]

Allows you to enable the bank memory interleaving. Configuration options: [Disabled] [Auto]

Channel Interleaving [XOR of Address bit]

Allows you to enable the channel memory interleaving.  
Configuration options: [Disabled] [Address bits 6] [Address bits 12] [XOR of Address bits [20:16, 6]] [XOR of Address bits [20:16, 9]]

Enable Clock to All DIMMs [Disabled]

Enables unused Clocks to DIMMs even though memory slots are not populated.  
Configuration options: [Disabled] [Enabled]

MemClk Tristate C3/ATLVID [Disabled]

Enables or disables MemClk Tri-Stating during C3 and Alt VID.  
Configuration options: [Disabled] [Enabled]

Memory Hole Remapping [Enabled]

Enables or disables memory remapping around memory hole.  
Configuration options: [Disabled] [Enabled]

DCT Unganged Mode [Always]

Enables or disables the unganged DRAM mode (64-bit width).  
Configuration options: [Auto] [Always]

Power Down Enable [Disabled]

Enables or disables the DDR power down mode. Configuration options: [Disabled] [Enabled]

#### ECC Configuration

ECC Mode [Disabled]

Enables or disables the DRAM ECC that allows the hardware to report and correct memory errors automatically. Configuration options: [Disabled] [Basic] [Good] [Super] [Max] [User]

#### Primary Display Adapter [GFX-GPP-PCI]

Allows you to set the primary display adapter. Configuration options: [GFX-GPP-PCI] [GPP-GFX-PCI] [PCI-GFX-GPP]



---

GFX: primary display adapter on the PCIe x16\_1 slot  
GPP: primary display adapter on the PCIe x16\_2 or PCIe x1 slot  
PCI: primary display adapter on the PCI slot

---

## 2.4.4 Onboard Device Configuration

### Serial Port1 Address [3F8/IRQ4]

Selects the Serial Port1 base address. Configuration options: [Disabled] [3F8/IRQ4] [2F8/IRQ3] [3E8/IRQ4] [2E8/IRQ3]

### Parallel Port Address [378]

Selects the Parallel Port base addresses. Configuration options: [Disabled] [378] [278] [3BC]

### Parallel Port Mode [Normal]

Selects the Parallel Port mode. Configuration options: [Normal] [EPP] [ECP] [EPP + ECP]

#### *Parallel Port IRQ [IRQ7]*

Allows BIOS to select the Parallel Port IRQ. Configuration options: [IRQ5] [IRQ7]

### HDAudio Controller [Enabled]

Enables or disables the high definition audio controller. Configuration options: [Disabled] [Enabled]

### Front Panel Select [HD Audio]

Selects the front panel type. Configuration options: [AC97] [HD Audio]

### OnBoard LAN Controller [Enabled]

Enables or disables the onboard LAN controller. Configuration options: [Disabled] [Enabled]

#### *OnBoard LAN Boot ROM [Disabled]*

Enables or disables the Onboard LAN Boot ROM. Configuration options: [Disabled] [Enabled]

### 1394 Controller [Enabled]

Enables or disables the 1394 Controller. Configurations options: [Disabled] [Enabled]

## 2.4.5 PCIPnP

The **PCI PnP** menu items allow you to change the advanced settings for PCI/PnP devices. The menu includes setting IRQ and DMA channel resources for either PCI/PnP or legacy ISA devices and setting the memory size block for legacy ISA devices.



---

Take caution when changing the settings of the PCI PnP menu items. Incorrect field values can cause the system to malfunction.

---

### Plug And Play O/S [No]

When this item is set to **[No]**, BIOS configures all the devices in the system. When this item is set to **[Yes]** and if you install a Plug and Play operating system, the operating system configures the Plug and Play devices not required for boot. Configuration options: [No] [Yes]

## 2.4.6 USB Configuration

The items in this menu allows you to change the USB-related features. Select an item then press <Enter> to display the configuration options.



---

The Module Version and USB Devices Enabled items show the auto-detected values. If no USB device is detected, the item shows **None**.

---

### USB Functions [Enabled]

Enables or disables the USB functions. Configuration options: [Disabled] [Enabled]

### USB 2.0 Controller [Enabled]

Enables or disables the USB 2.0 controller. Configuration options: [Disabled] [Enabled]

### Legacy USB Support [Auto]

Enables or disables support for Legacy USB storage devices including USB flash drives and USB hard drives. Setting this item to **[Auto]** allows the system to detect the presence of USB devices at startup. If detected, the USB controller legacy mode is enabled. If no USB device is detected, the legacy USB support is disabled. Configuration options: [Disabled] [Enabled] [Auto]

### USB 2.0 Controller Mode [HiSpeed]

Configures the USB 2.0 controller in HiSpeed (480Mbps) mode or FullSpeed (12Mbps) mode. Configuration options: [FullSpeed] [HiSpeed]



---

The following items only appear when a USB storage device is plugged in.

---

## USB Mass Storage Device Configuration

### USB Mass Storage Reset Delay [20 Sec]

Sets the maximum time that the BIOS waits for the USB storage device to initialize. Configuration options: [10 Sec] [20 Sec] [30 Sec] [40 Sec]

#### *Emulation Type [Auto]*

Allows you to set the emulation type. Configuration options: [Auto] [Floppy] [Forced FDD] [Hard Disk] [CDROM]

## 2.5 Power menu

The Power menu items allow you to change the settings for the Advanced Configuration and Power Interface (ACPI) and the Advanced Power Management (APM). Select an item then press **<Enter>** to display the configuration options.

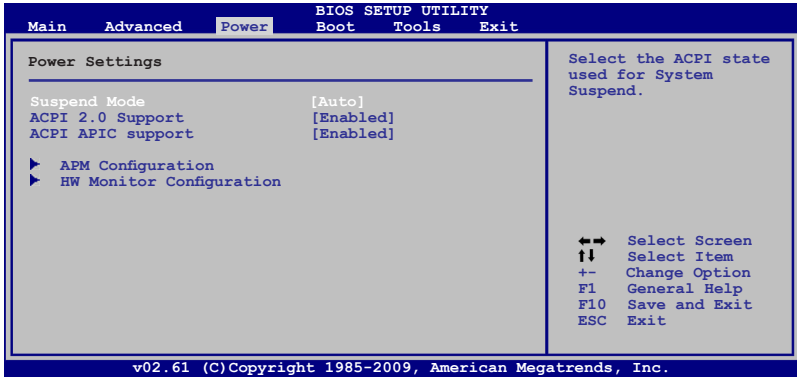

### 2.5.1 Suspend Mode [Auto]

Selects the Advanced Configuration and Power Interface (ACPI) state to be used for system suspend. Configuration options: [S1 (POS) Only] [S3 Only] [Auto]

### 2.5.2 ACPI 2.0 Support [Enabled]

Enables or disables the Advanced Configuration and Power Interface (ACPI) 2.0 support. Configuration options: [Disabled] [Enabled]

### 2.5.3 ACPI APIC Support [Enabled]

Enables or disables the Advanced Configuration and Power Interface (ACPI) support in the Advanced Programmable Interrupt Controller (APIC). When this item is set to **[Enabled]**, the ACPI APIC table pointer is included in the RSDT pointer list. Configuration options: [Disabled] [Enabled]

### 2.5.4 APM Configuration

#### Restore on AC Power Loss [Power Off]

When this item set to **[Power Off]**, the system goes into off state after an AC power loss. When this item set to **[Power On]**, the system goes on after an AC power loss. Configuration options: [Power Off] [Power On] [Last State]

#### Power on From S5 By PME# [Disabled]

Enables or disables PME wake from sleep states. Configuration options: [Disabled] [Enabled]

#### Power on From S5 By Ring [Disabled]

Enables or disables ring to generate a wake event. Configuration options: [Disabled] [Enabled]



### **Power on By PS/2 Keyboard [Disabled]**

Enables or disables PS/2 Keyboard to generate a wake event.  
Configuration options: [Disabled] [Space Bar] [Power Key] [Ctrl - Esc]

### **Power on From S5 By RTC Alarm [Disabled]**

Enables or disables RTC to generate a wake event. Configuration options: [Disabled]  
[Enabled]

## **2.5.5 HW Monitor Configuration**

### **CPU / MB Temperature [xxx°C/xxx°F] or [Ignored]**

The onboard hardware monitor automatically detects and displays the motherboard and CPU temperatures. Select **[Ignored]** if you do not want the detected temperatures to be displayed.

### **CPU / Chassis Fan Speed [xxxxRPM] or [Ignored]**

The onboard hardware monitor automatically detects and displays the CPU / Chassis fan speeds in rotations per minute (RPM). If the fan is not connected to the motherboard, the field shows N/A. Select **[Ignored]** if you do not wish to display the detected speed.

### **VCORE Voltage, 3.3V Voltage, 5V Voltage, 12V Voltage [xx.xxxV] or [Ignored]**

The onboard hardware monitor automatically detects the voltage output through the onboard voltage regulators. Select **[Ignored]** if you do not want the detected voltage to be displayed.

### **Smart Q-Fan Function [Disabled]**

Allows you to enable or disable the ASUS Q-Fan feature that smartly adjusts the fan speeds for more efficient system operation. Configuration options: [Disabled] [Enabled]

### **Fan Auto Mode Start Voltage [5.0V]**

Allows you to select the fan auto mode start voltage. Configuration options: [4.0V] [4.5V]  
[5.0V] [5.5V] [6.0V]

### **Fan Auto Mode Start Speed Temp [25°C]**

Allows you to set the smart Q-Fan start working temperature. Configuration options: [25°C] ~  
[48°C]

### **Fan Auto Mode Full Speed Temp [55°C]**

Allows you to set the smart Q-Fan full speed temperature. Configuration options: [51°C] ~  
[75°C]

## 2.6 Boot menu

The **Boot** menu items allow you to change the system boot options. Select an item then press **<Enter>** to display the sub-menu.

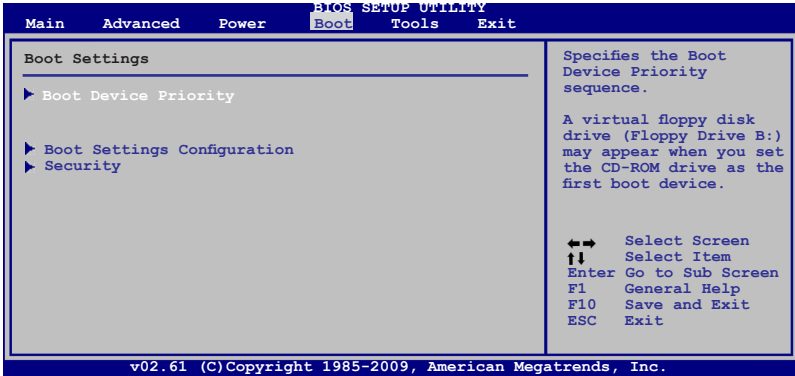

### 2.6.1 Boot Device Priority

#### 1st ~ xxth Boot Device [xxx Drive]

These items specify the boot device priority sequence from the available devices. The number of device items that appears on the screen depends on the number of devices installed in the system. Configuration options: [Removable Dev.] [Hard Drive] [ATAPI CD-ROM] [Disabled]



- To select the boot device during system startup, press **<F8>** when ASUS Logo appears.
- To access Windows® OS in Safe Mode, do any of the following:
  - Press **<F5>** when ASUS Logo appears.
  - Press **<F8>** after POST.

### 2.6.2 Boot Settings Configuration

#### Quick Boot [Enabled]

Enabling this item allows the BIOS to skip some power on self tests (POST) while booting to decrease the time needed to boot the system. When this item is set to **[Disabled]**, BIOS performs all the POST items. Configuration options: [Disabled] [Enabled]

#### Full Screen Logo [Enabled]

Enables or disables the full screen logo display feature. Configuration options: [Disabled] [Enabled]



Set this item to **[Enabled]** to use the ASUS MyLogo2™ feature.

#### AddOn ROM Display Mode [Force BIOS]

Sets the display mode for option ROM. Configuration options: [Force BIOS] [Keep Current]

### Bootup Num-Lock [On]

Selects the power-on state for the NumLock. Configuration options: [Off] [On]

### Wait for 'F1' If Error [Enabled]

When this item is set to **[Enabled]**, the system waits for the F1 key to be pressed when error occurs. Configuration options: [Disabled] [Enabled]

### Hit 'DEL' Message Display [Enabled]

When this item is set to **[Enabled]**, the system displays the message **Press DEL to run Setup** during POST. Configuration options: [Disabled] [Enabled]

## 2.6.3 Security

The Security menu items allow you to change the system security settings. Select an item then press **<Enter>** to display the configuration options.

### Change Supervisor Password

Select this item to set or change the supervisor password. The **Supervisor Password** item on top of the screen shows the default **Not Installed**. After you set a password, this item shows **Installed**.

To set a Supervisor Password:

1. Select the **Change Supervisor Password** item and press **<Enter>**.
2. On the password box, key in a password containing up to six letters or numbers, or both, then press **<Enter>**.
3. Confirm the password when prompted.

The message **Password Installed** appears after you successfully set your password.

To change the supervisor password, follow the same steps as in setting a supervisor password.

To clear the supervisor password, select the **Change Supervisor Password** then press **<Enter>** twice. The message **Password uninstalled** appears.



---

If you forget your BIOS password, you can clear it by erasing the CMOS Real Time Clock (RTC) RAM. See section **1.9 Jumpers** for information on how to erase the RTC RAM.

---

After you have set a supervisor password, the other items appear to allow you to change other security settings.

### User Access Level [Full Access]

This item allows you to select the access restriction to the Setup items. Configuration options: [No Access] [View Only] [Limited] [Full Access]

**No Access** prevents user access to the Setup utility.

**View Only** allows access but does not allow change to any field.

**Limited** allows changes only to selected fields, such as Date and Time.

**Full Access** allows viewing and changing all the fields in the Setup utility.

## Change User Password

Select this item to set or change the user password. The **User Password** item on top of the screen shows the default **Not Installed**. After you set a password, this item shows **Installed**.

To set a User Password:

1. Select the **Change User Password** item and press **<Enter>**.
2. On the password box, key in a password containing up to six letters or numbers, or both, then press **<Enter>**.
3. Confirm the password when prompted.

The message **"Password Installed"** appears after you set your password successfully.

To change the user password, follow the same steps as in setting a user password.

## Clear User Password

Select this item to clear the user password.

## Password Check [Setup]

When this item is set to **[Setup]**, BIOS checks for user password when accessing the Setup utility. When this item is set to **[Always]**, BIOS checks for user password both when accessing Setup and booting the system. Configuration options: [Setup] [Always]

## 2.7 Tools menu

The **Tools** menu items allow you to configure options for special functions. Select an item then press **<Enter>** to display the submenu.

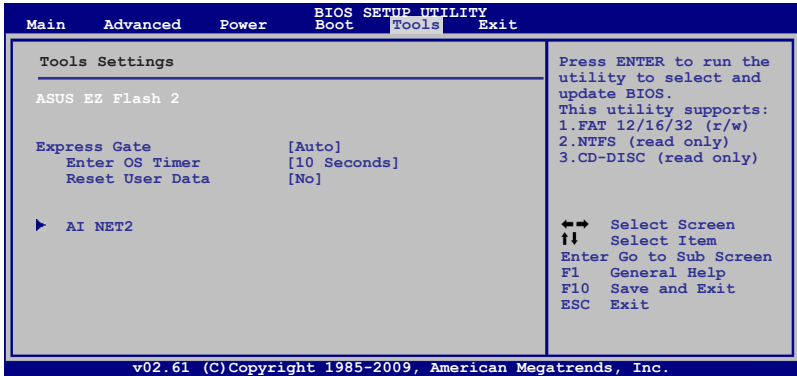

### 2.7.1 ASUS EZ Flash 2

Allows you to run ASUS EZ Flash 2. When you press **<Enter>**, a confirmation message appears. Use the left/right arrow key to select between **[Yes]** or **[No]**, then press **<Enter>** to confirm your choice.

## 2.7.2 Express Gate [Auto]

Enables or disables the ASUS Express Gate feature. ASUS Express Gate is a unique instant-on environment that provides quick access to the Internet and Skype.

Configuration options: [Disabled] [Enabled] [Auto]

### *Enter OS Timer [10 Seconds]*

Sets countdown duration that the system waits at the Express Gate's first screen before starting Windows or other installed OS. Choose [Prompt User] to stay at the first screen of Express Gate for user action. Configuration options: [Prompt User] [1 second] [3 seconds] [5 seconds] [10 seconds] [15 seconds] [20 seconds] [30 seconds]

### *Reset User Data [No]*

Allows you to clear Express Gate's user data. Configuration options: [No] [Reset]

When setting this item to **[Reset]**, ensure to save the setting to the BIOS so that the user data will be cleared the next time you enter the Express Gate. User data includes the Express Gate's settings as well as any personal information stored by the web browser (bookmarks, cookies, browsing history, etc.). This is useful in the rare case where corrupt settings prevent the Express Gate environment from launching properly.



---

The first time wizard will run again when you enter the Express Gate environment after clearing its settings.

---

## 2.7.3 AI NET 2

### **Check Realtek LAN cable [Disabled]**

Enables or disables checking of the Realtek LAN cable during the Power-On Self-Test (POST). Configuration options: [Disabled] [Enabled]

## 2.8 Exit menu

The **Exit** menu items allow you to load the optimal or failsafe default values for the BIOS items, and save or discard your changes to the BIOS items.

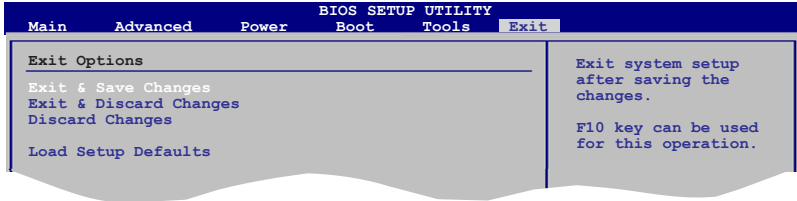

Pressing **<Esc>** does not immediately exit this menu. Select one of the options from this menu or **<F10>** from the legend bar to exit.

### Exit & Save Changes

Once you are finished making your selections, choose this option from the Exit menu to ensure the values you selected are saved to the CMOS RAM. An onboard backup battery sustains the CMOS RAM so it stays on even when the PC is turned off. When you select this option, a confirmation window appears. Select **OK** to save changes and exit.

### Exit & Discard Changes

Select this option only if you do not want to save the changes that you made to the Setup program. If you made changes to fields other than System Date, System Time, and Password, the BIOS asks for a confirmation before exiting.

### Discard Changes

This option allows you to discard the selections you made and restore the previously saved values. After selecting this option, a confirmation appears. Select **OK** to discard any changes and load the previously saved values.

### Load Setup Defaults

This option allows you to load the default values for each of the parameters on the Setup menus. When you select this option or if you press **<F5>**, a confirmation window appears. Select **OK** to load default values. Select **Exit & Save Changes** or make other changes before saving the values to the non-volatile RAM.