

Analogue Reference

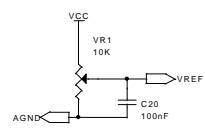

RS232 Circuit

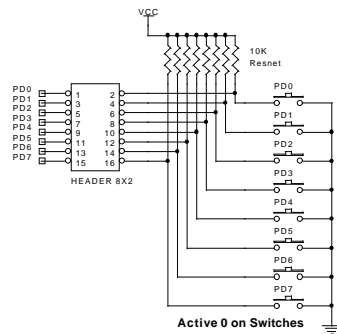
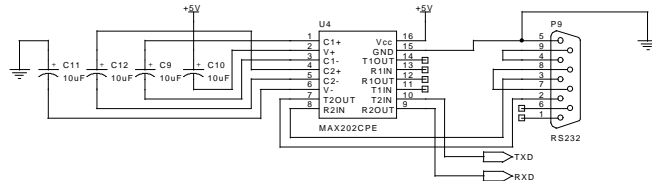

Lights and Switches

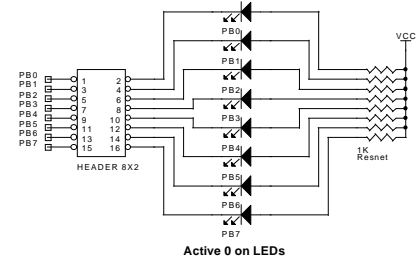

LCD Timing Circuit

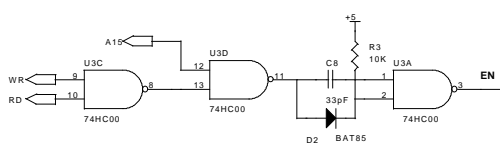

LCD Interface

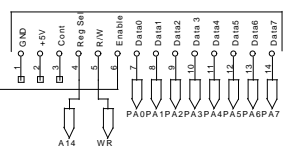

Interface Connection

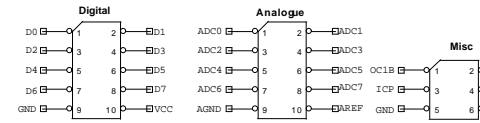

Brownout Detector Circuit

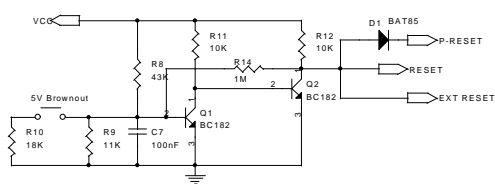

Decoupling Capacitors

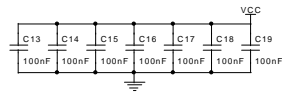

Clock Generation Circuit

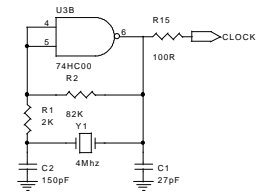

External Power Source

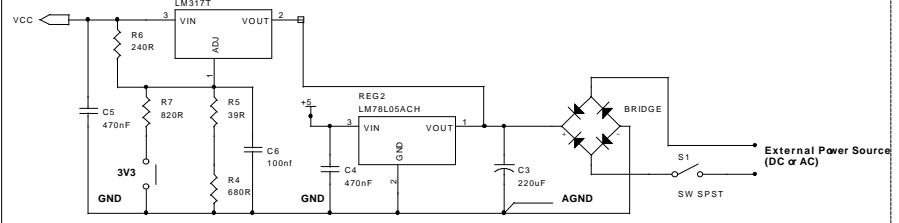

Programming Interface

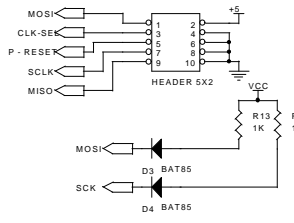

External RAM Connection

