







Rest

-  = 1W
-  = 0.5 W
-  = 0.25 W
-  = 0.125 W
-  = 10 W
-  = 18 W

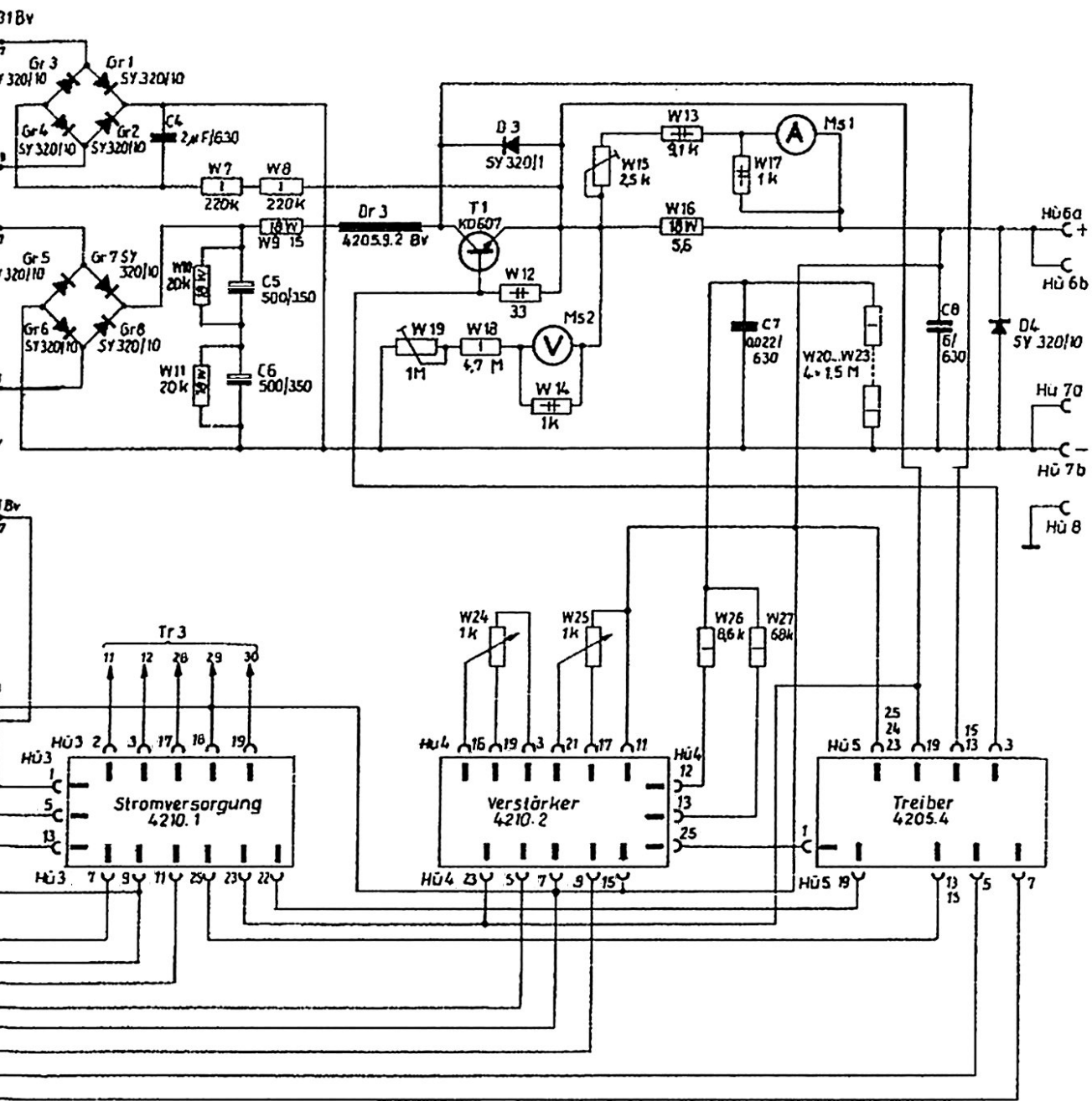

Restauriert/ korrigiert: Edi

Statron 4210
600V/0,2A

Edi
Transistor-Gleichspannungs-
regler Typ 4210
4210 Sp