

Cascadable Silicon Bipolar MMIC Amplifier

Technical Data

MSA-0520

Features

- **Cascadable 50 Ω Gain Block**
- **High Output Power:**
+23 dBm Typical $P_{1\text{ dB}}$ at
1.0 GHz
- **Low Distortion:**
33 dBm Typical IP_3 at 1.0 GHz
- **8.5 dB Typical Gain at
1.0 GHz**
- **Hermetic Metal/Beryllia
Microstrip Package**

Description

The MSA-0520 is a high performance silicon bipolar Monolithic Microwave Integrated Circuit (MMIC) housed in a hermetic,

BeO disk package for good thermal characteristics. This MMIC is designed for use as a general purpose 50 Ω gain block. Typical applications include narrow and broad band IF and RF amplifiers in industrial and military applications.

The MSA-series is fabricated using HP's 10 GHz f_T , 25 GHz f_{MAX} , silicon bipolar MMIC process which uses nitride self-alignment, ion implantation, and gold metallization to achieve excellent performance, uniformity and reliability. The use of an external bias resistor for temperature and current stability also allows bias flexibility.

200 mil BeO Package

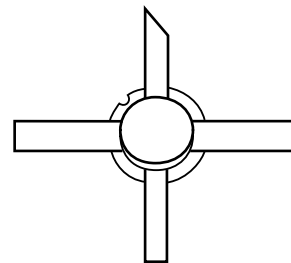

Typical Biasing Configuration

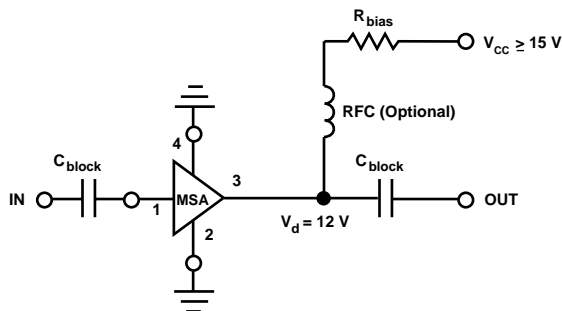

MSA-0520 Absolute Maximum Ratings

Parameter	Absolute Maximum ^[1]
Device Current	225 mA
Power Dissipation ^[2,3]	3.0 W
RF Input Power	+25 dBm
Junction Temperature	200°C
Storage Temperature	-65 to 200°C

Thermal Resistance^[2,4]:

$$\theta_{jc} = 25^{\circ}\text{C/W}$$

Notes:

1. Permanent damage may occur if any of these limits are exceeded.
2. $T_{\text{CASE}} = 25^{\circ}\text{C}$.
3. Derate at 40 mW/°C for $T_{\text{C}} > 125^{\circ}\text{C}$.
4. The small spot size of this technique results in a higher, though more accurate determination of θ_{jc} than do alternate methods. See MEASUREMENTS section "Thermal Resistance" for more information.

Electrical Specifications^[1], $T_{\text{A}} = 25^{\circ}\text{C}$

Symbol	Parameters and Test Conditions: $I_{\text{d}} = 165 \text{ mA}$, $Z_{\text{o}} = 50 \Omega$	Units	Min.	Typ.	Max.
$P_{1 \text{ dB}}$	Output Power at 1 dB Gain Compression $f = 1.0 \text{ GHz}$	dBm	21.0	23.0	
G_{P}	Power Gain ($ S_{21} ^2$) $f = 0.1 \text{ GHz}$	dB	7.5	8.5	9.5
ΔG_{P}	Gain Flatness $f = 0.1 \text{ to } 2.0 \text{ GHz}$	dB		± 0.75	
$f_{3 \text{ dB}}$	3 dB Bandwidth ^[2]	GHz		2.8	
VSWR	Input VSWR $f = 0.1 \text{ to } 2.0 \text{ GHz}$			2.0:1	
	Output VSWR $f = 0.1 \text{ to } 2.0 \text{ GHz}$			2.5:1	
IP_3	Third Order Intercept Point $f = 1.0 \text{ GHz}$	dBm		33.0	
$\text{NF}_{50\Omega}$	50 Ω Noise Figure $f = 1.0 \text{ GHz}$	dB		6.5	
t_{D}	Group Delay $f = 1.0 \text{ GHz}$	psec		170	
V_{d}	Device Voltage	V	10.5	12.0	13.5
dV/dT	Device Voltage Temperature Coefficient	mV/°C		-16.0	

Notes:

1. The recommended operating current range for this device is 80 to 200 mA. Typical performance as a function of current is on the following page.
2. Referenced from 0.1 GHz Gain (G_{P}).

MSA-0520 Typical Scattering Parameters ($T_A = 25^\circ\text{C}$, $I_d = 165\text{ mA}$)

Freq. MHz	S_{11}		S_{21}			S_{12}			S_{22}		k
	Mag	Ang	dB	Mag	Ang	dB	Mag	Ang	Mag	Ang	
5	.57	-38	14.4	5.25	165	-19.4	.107	38	.67	-35	0.57
25	.25	-90	10.7	3.42	160	-14.9	.180	17	.29	-81	0.93
50	.15	-111	9.5	2.97	163	-14.4	.190	9	.18	-97	1.10
100	.11	-138	8.9	2.80	166	-14.2	.195	3	.11	-113	1.16
200	.10	-152	8.8	2.75	163	-14.1	.197	1	.10	-125	1.17
400	.10	-152	8.7	2.72	152	-14.1	.198	-2	.14	-123	1.16
600	.11	-147	8.6	2.70	140	-14.0	.199	-4	.18	-123	1.14
800	.13	-142	8.5	2.67	128	-14.1	.199	-6	.22	-127	1.12
1000	.15	-140	8.4	2.64	115	-14.1	.198	-8	.27	-131	1.09
1500	.22	-142	8.0	2.52	85	-13.7	.206	-12	.34	-143	0.98
2000	.30	-156	7.4	2.36	55	-13.3	.216	-16	.43	-158	0.85
2500	.37	-170	6.7	2.16	33	-12.9	.227	-18	.48	-166	0.75
3000	.41	170	5.6	1.91	8	-12.7	.232	-23	.51	-177	0.70
3500	.45	149	4.5	1.68	-16	-12.1	.249	-31	.55	173	0.63
4000	.46	124	3.3	1.45	-40	-11.7	.259	-39	.56	162	0.66

A model for this device is available in the DEVICE MODELS section.

Typical Performance, $T_A = 25^\circ\text{C}$

(unless otherwise noted)

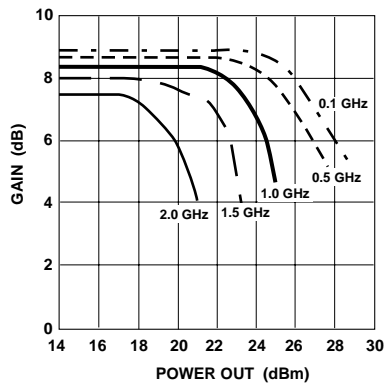

Figure 1. Typical Gain vs. Power Out, $T_A = 25^\circ\text{C}$, $I_d = 165\text{ mA}$.

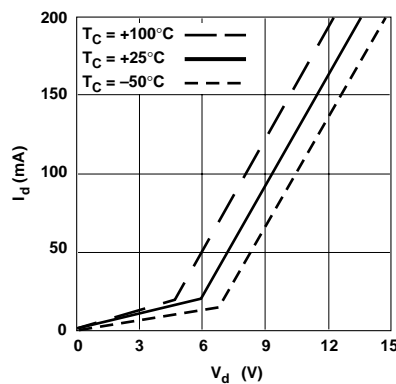

Figure 2. Device Current vs. Voltage.

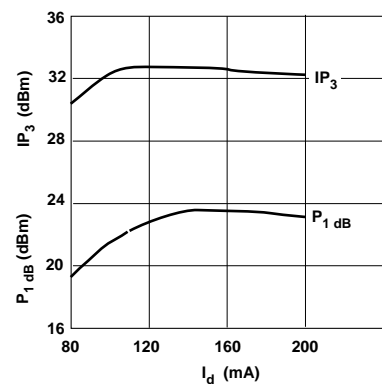

Figure 3. Output Power at 1 dB Gain Compression, Third Order Intercept vs. Current, $f = 1.0\text{ GHz}$.

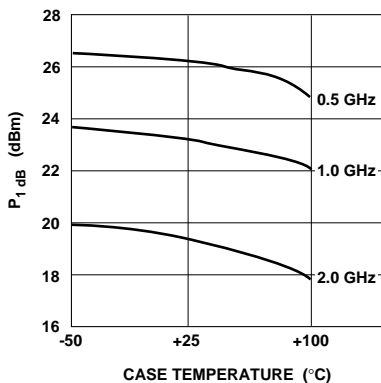

Figure 4. Output Power @ 1 dB Gain Compression vs. Temperature, $I_d = 165\text{ mA}$.

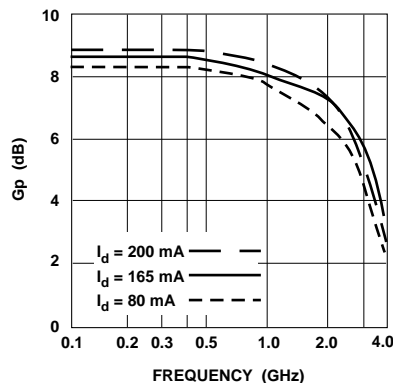

Figure 5. Gain vs. Frequency.

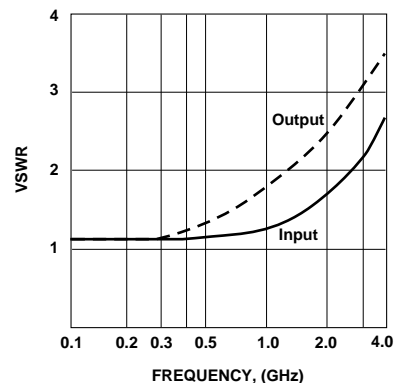

Figure 6. VSWR vs. Frequency, $I_d = 165\text{ mA}$.

