

Title		
MEGA_SYSTEM		
Size	Number	Revision
A 3	V0.2	
Date:	11/26/2021	Sheet of Sheet1
File:	E:\OTHER\...\Sheet1.SchDoc	Drawn By: TR_PCB

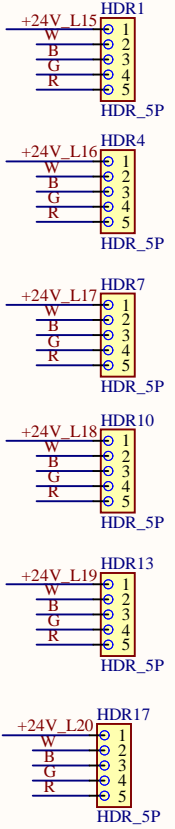
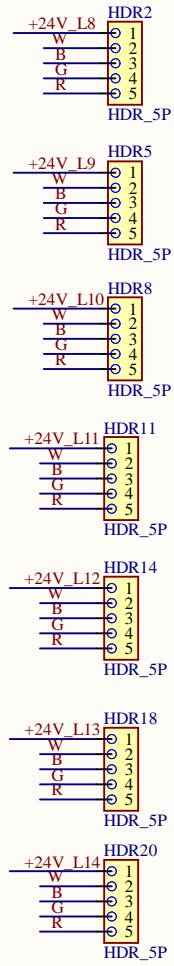
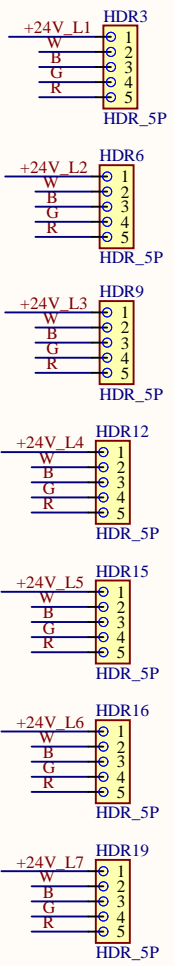
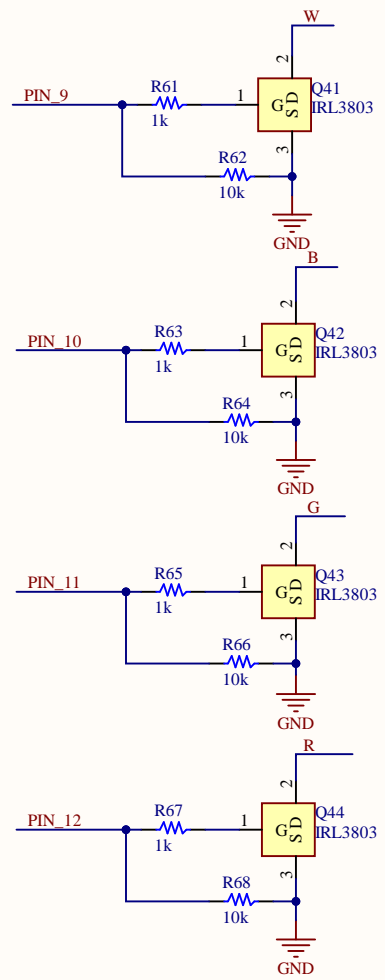

LED_Strip_Connectors

Title		
MEGA_SYSTEM		
Size	Number	Revision
A 3	V0.2	
Date:	11/26/2021	Sheet of Sheet2
File:	E:\OTHER\...\Sheet2.SchDoc	Drawn By: TR_PCB

A

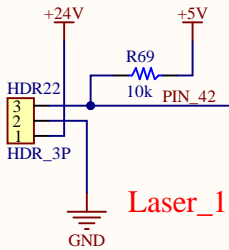

Laser_1

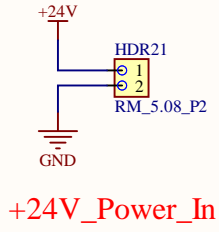

+24V_Power_In

B

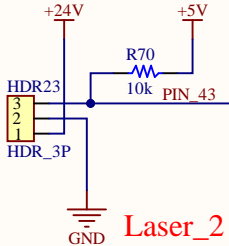

Laser_2

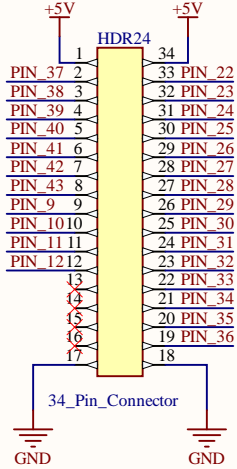

34_Pin_Connector

MCU

D

Title		
MEGA_SYSTEM		
Size	Number	Revision
A 3	V0.2	
Date:	11/26/2021	Sheet of Sheet3
File:	E:\OTHER\...\Sheet3.SchDoc	Drawn By: TR_PCB