

IGBT – Hybrid, Field Stop, Trench

650 V, 75 A, TO247

AFGHL75T65SQDC

Using the novel field stop 4th generation IGBT technology and the 1.5th generation SiC Schottky Diode technology, AFGHL75T65SQDC offers the optimum performance with both low conduction and switching losses for high efficiency operations in various applications, especially totem pole bridgeless PFC and Inverter.

Features

- Maximum Junction Temperature: $T_J = 175^\circ\text{C}$
- Positive Temperature Co-efficient for Easy Parallel Operating
- High Current Capability
- Low Saturation Voltage: $V_{CE(Sat)} = 1.6\text{ V (Typ.) @ } I_C = 75\text{ A}$
- 100% of the Parts are Tested for I_{LM} (Note 2)
- Fast Switching
- Tight Parameter Distribution
- No Reverse Recovery/No Forward Recovery
- AEC-Q101 Qualified and PPAP Capable

Typical Applications

- Automotive
- On & Off Board Chargers
- DC-DC Converters
- PFC
- Industrial Inverter

MAXIMUM RATINGS

Rating	Symbol	Value	Unit
Collector-to-Emitter Voltage	V_{CES}	650	V
Gate-to-Emitter Voltage Transient Gate-to-Emitter Voltage	V_{GES}	± 20 ± 30	V
Collector Current (Note 1)	I_C	80 75	A
		@ $T_C = 25^\circ\text{C}$ @ $T_C = 100^\circ\text{C}$	
Pulsed Collector Current (Note 2)	I_{LM}	300	A
Pulsed Collector Current (Note 3)	I_{CM}	300	A
Diode Forward Current (Note 1)	I_F	35 20	A
		@ $T_C = 25^\circ\text{C}$ @ $T_C = 100^\circ\text{C}$	
Pulsed Diode Maximum Forward Current	I_{FM}	200	A
Maximum Power Dissipation	P_D	375 188	W
		@ $T_C = 25^\circ\text{C}$ @ $T_C = 100^\circ\text{C}$	
Operating Junction / Storage Temperature Range	T_J , T_{STG}	-55 to $+175$	$^\circ\text{C}$
Maximum Lead Temp. for Soldering Purposes, 1/8" from case for 10 seconds	T_L	265	$^\circ\text{C}$

Stresses exceeding those listed in the Maximum Ratings table may damage the device. If any of these limits are exceeded, device functionality should not be assumed, damage may occur and reliability may be affected.

1. Value limited by bond wire
2. $V_{CC} = 400\text{ V}$, $V_{GE} = 15\text{ V}$, $I_C = 300\text{ A}$, $R_G = 15\ \Omega$, Inductive Load, 100% of the Parts are Tested.
3. Repetitive Rating: pulse width limited by max. Junction temperature



ON Semiconductor®

www.onsemi.com

75 A, 650 V
 $V_{CESat} = 1.6\text{ V (Typ.)}$

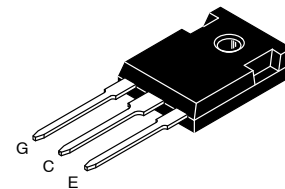
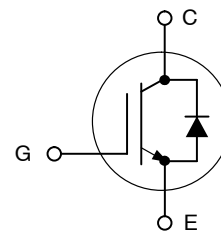

TO-247-3LD
CASE 340CX

MARKING DIAGRAM



A = Assembly Location
 YWW = 3-Digit Date Code
 ZZ = 2-Digit Lot Traceability Code
 AFGHL75T65SQDC = Specific Device Code

ORDERING INFORMATION

Device	Package	Shipping
AFGHL75T65SQDC	TO-247-3L	30 Units / Rail

AFGHL75T65SQDC

THERMAL CHARACTERISTICS

Rating	Symbol	Max	Unit
Thermal resistance junction-to-case, for IGBT	$R_{\theta JC}$	0.4	$^{\circ}\text{C/W}$
Thermal resistance junction-to-case, for Diode	$R_{\theta JC}$	1.55	$^{\circ}\text{C/W}$
Thermal resistance junction-to-ambient	$R_{\theta JA}$	40	$^{\circ}\text{C/W}$

ELECTRICAL CHARACTERISTICS ($T_J = 25^{\circ}\text{C}$ unless otherwise noted)

Parameter	Test Conditions	Symbol	Min	Typ	Max	Unit
-----------	-----------------	--------	-----	-----	-----	------

OFF CHARACTERISTICS

Collector-emitter breakdown voltage, gate-emitter short-circuited	$V_{GE} = 0\text{ V},$ $I_C = 1\text{ mA}$	BV_{CES}	650	-	-	V
Temperature Coefficient of Breakdown Voltage	$V_{GE} = 0\text{ V},$ $I_C = 1\text{ mA}$	$\frac{\Delta BV_{CES}}{\Delta T_J}$	-	0.6	-	$\text{V}/^{\circ}\text{C}$
Collector-emitter cut-off current, gate-emitter short-circuited	$V_{GE} = 0\text{ V},$ $V_{CE} = 650\text{ V}$	I_{CES}	-	-	250	μA
Gate leakage current, collector-emitter short-circuited	$V_{GE} = 20\text{ V},$ $V_{CE} = 0\text{ V}$	I_{GES}	-	-	± 400	nA

ON CHARACTERISTICS

Gate-emitter threshold voltage	$V_{GE} = V_{CE}, I_C = 75\text{ mA}$	$V_{GE(th)}$	3.4	4.9	6.4	V
Collector-emitter saturation voltage	$V_{GE} = 15\text{ V}, I_C = 75\text{ A}$ $V_{GE} = 15\text{ V}, I_C = 75\text{ A}, T_J = 175^{\circ}\text{C}$	$V_{CE(sat)}$	-	1.6	2.1	V
			-	2.0	-	

DYNAMIC CHARACTERISTICS

Input capacitance	$V_{CE} = 30\text{ V},$ $V_{GE} = 0\text{ V},$ $f = 1\text{ MHz}$	C_{ies}	-	4574	-	μF
Output capacitance		C_{oes}	-	289.4	-	
Reverse transfer capacitance		C_{res}	-	11.2	-	
Gate charge total	$V_{CE} = 400\text{ V},$ $I_C = 75\text{ A},$ $V_{GE} = 15\text{ V}$	Q_g	-	139	-	nC
Gate-to-emitter charge		Q_{ge}	-	25	-	
Gate-to-collector charge		Q_{gc}	-	33	-	

SWITCHING CHARACTERISTICS, INDUCTIVE LOAD

Turn-on delay time	$T_C = 25^{\circ}\text{C},$ $V_{CC} = 400\text{ V},$ $I_C = 37.5\text{ A},$ $R_G = 4.7\ \Omega,$ $V_{GE} = 15\text{ V},$ Inductive Load	$t_{d(on)}$	-	22.4	-	ns
Rise time		t_r	-	19.2	-	
Turn-off delay time		$t_{d(off)}$	-	116.8	-	
Fall time		t_f	-	9.6	-	
Turn-on switching loss		E_{on}	-	0.48	-	mJ
Turn-off switching loss		E_{off}	-	0.24	-	
Total switching loss		E_{ts}	-	0.72	-	
Turn-on delay time	$T_C = 25^{\circ}\text{C},$ $V_{CC} = 400\text{ V},$ $I_C = 75\text{ A},$ $R_G = 4.7\ \Omega,$ $V_{GE} = 15\text{ V},$ Inductive Load	$t_{d(on)}$	-	24	-	ns
Rise time		t_r	-	49.6	-	
Turn-off delay time		$t_{d(off)}$	-	107.2	-	
Fall time		t_f	-	70.4	-	
Turn-on switching loss		E_{on}	-	1.68	-	mJ
Turn-off switching loss		E_{off}	-	1.11	-	
Total switching loss		E_{ts}	-	2.79	-	

AFGHL75T65SQDC

ELECTRICAL CHARACTERISTICS ($T_J = 25^\circ\text{C}$ unless otherwise noted)

Parameter	Test Conditions	Symbol	Min	Typ	Max	Unit
-----------	-----------------	--------	-----	-----	-----	------

SWITCHING CHARACTERISTICS, INDUCTIVE LOAD

Turn-on delay time	$T_C = 175^\circ\text{C}$, $V_{CC} = 400\text{ V}$, $I_C = 37.5\text{ A}$, $R_G = 4.7\ \Omega$, $V_{GE} = 15\text{ V}$, Inductive Load	$t_{d(on)}$	-	20.8	-	ns
Rise time		t_r	-	22.4	-	
Turn-off delay time		$t_{d(off)}$	-	130	-	
Fall time		t_f	-	9.6	-	
Turn-on switching loss		E_{on}	-	0.53	-	mJ
Turn-off switching loss		E_{off}	-	0.44	-	
Total switching loss		E_{ts}	-	0.98	-	
Turn-on delay time	$T_C = 175^\circ\text{C}$, $V_{CC} = 400\text{ V}$, $I_C = 75\text{ A}$, $R_G = 4.7\ \Omega$, $V_{GE} = 15\text{ V}$, Inductive Load	$t_{d(on)}$	-	24	-	ns
Rise time		t_r	-	49.6	-	
Turn-off delay time		$t_{d(off)}$	-	118	-	
Fall time		t_f	-	78.4	-	
Turn-on switching loss		E_{on}	-	1.76	-	mJ
Turn-off switching loss		E_{off}	-	1.42	-	
Total switching loss		E_{ts}	-	3.19	-	

DIODE CHARACTERISTICS

Forward Voltage	$I_F = 20\text{ A}$	V_F	-	1.45	1.75	V
	$I_F = 20\text{ A}, T_J = 175^\circ\text{C}$		-	1.80	-	
Total Capacitance	$V_R = 400\text{ V}, f = 1\text{ MHz}$	C	-	110	-	pF
	$V_R = 600\text{ V}, f = 1\text{ MHz}$		-	105	-	

Product parametric performance is indicated in the Electrical Characteristics for the listed test conditions, unless otherwise noted. Product performance may not be indicated by the Electrical Characteristics if operated under different conditions.

AFGHL75T65SQDC

TYPICAL CHARACTERISTICS

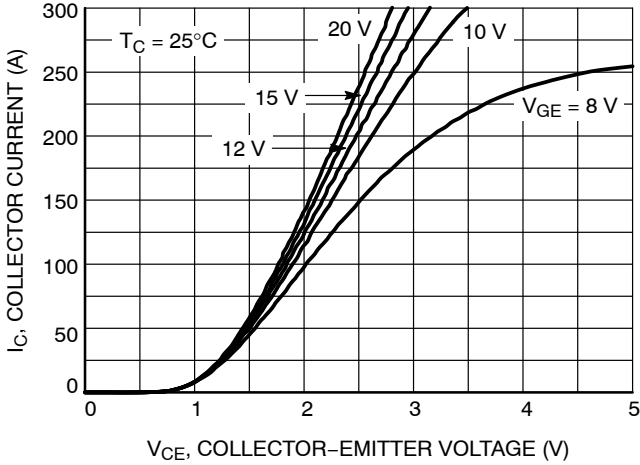

Figure 1. Typical Output Characteristics
($T_c = 25^\circ\text{C}$)

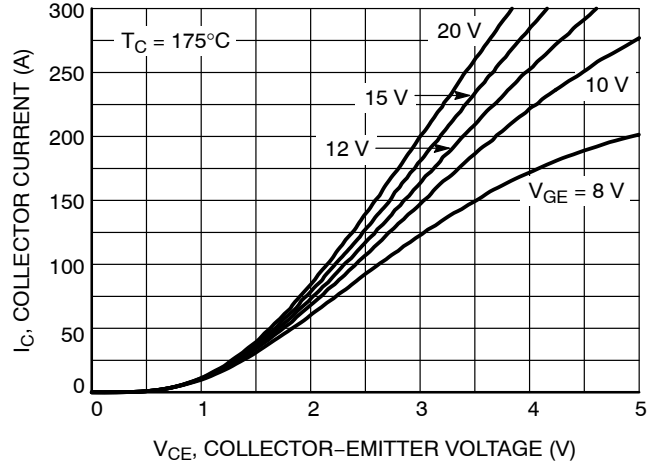

Figure 2. Typical Output Characteristics
($T_c = 175^\circ\text{C}$)

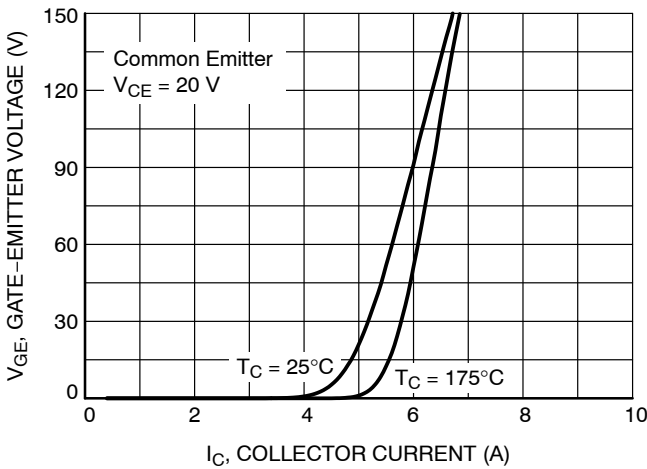

Figure 3. Transfer Characteristics

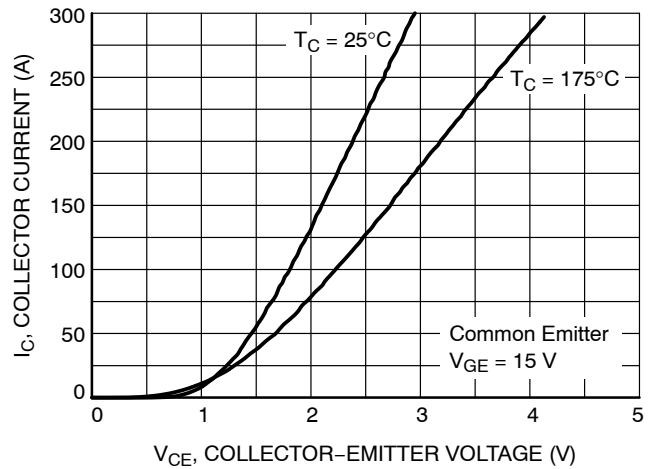

Figure 4. Typical Saturation Voltage Characteristics

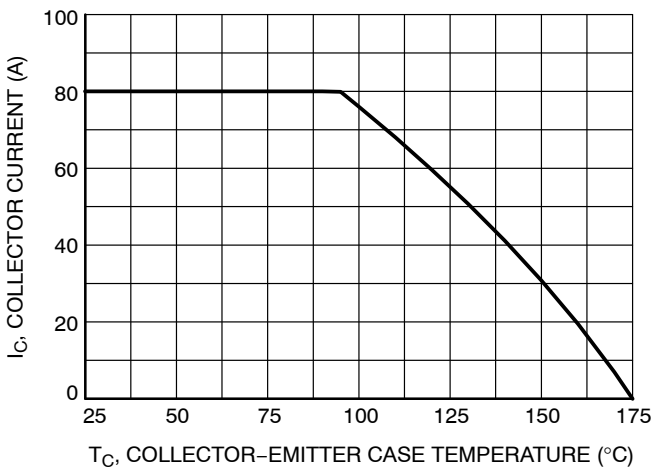

Figure 5. Collector Current Derating

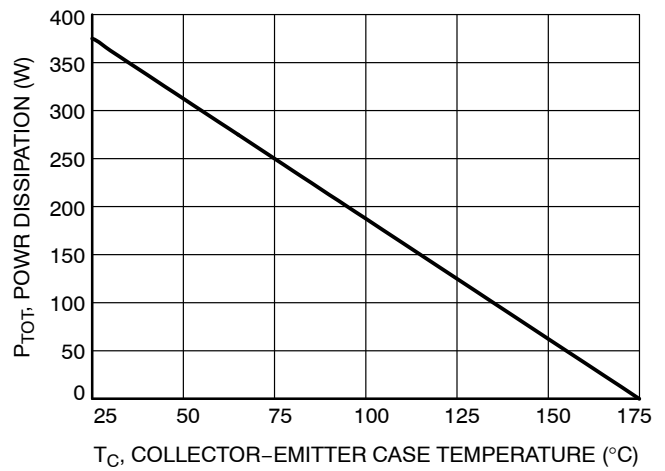

Figure 6. Power Dissipation

AFGHL75T65SQDC

TYPICAL CHARACTERISTICS

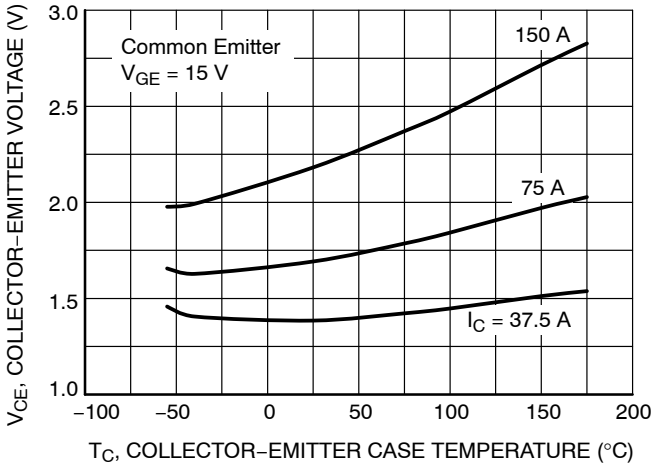

Figure 7. Saturation Voltage vs. Case Temperature at Variant Current Level

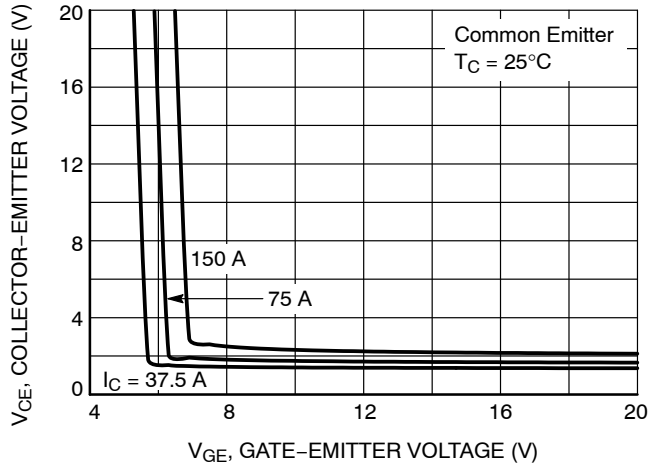

Figure 8. Saturation Voltage vs. V_{GE} (T_C = 25°C)

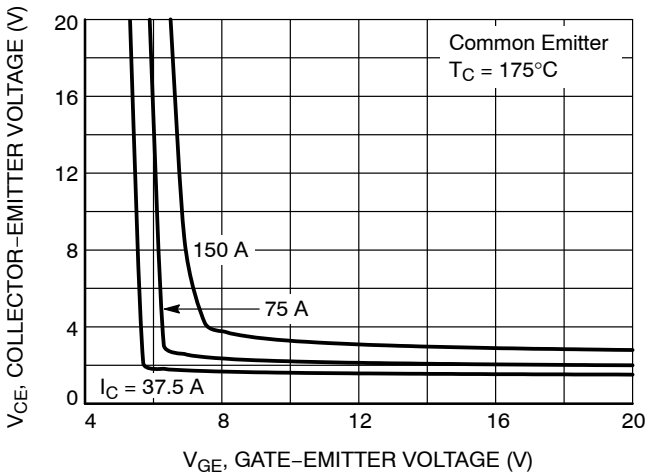

Figure 9. Saturation Voltage vs. V_{GE} (T_C = 175°C)

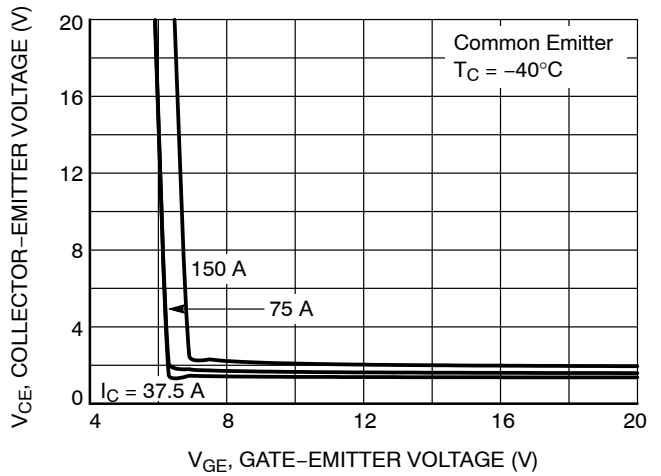

Figure 10. Saturation Voltage vs. V_{GE} (T_C = -40°C)

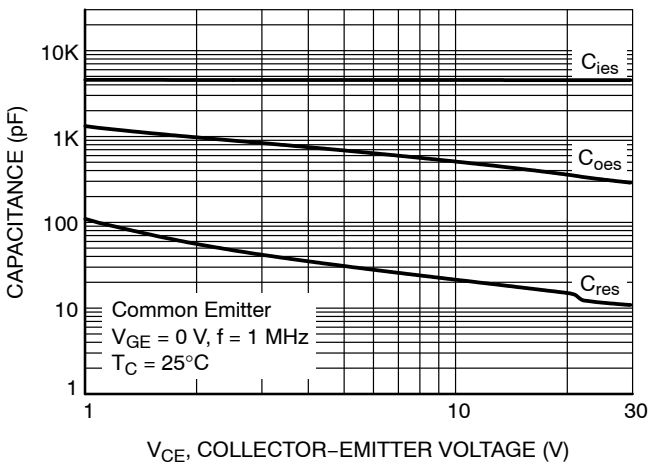

Figure 11. Capacitance Characteristics

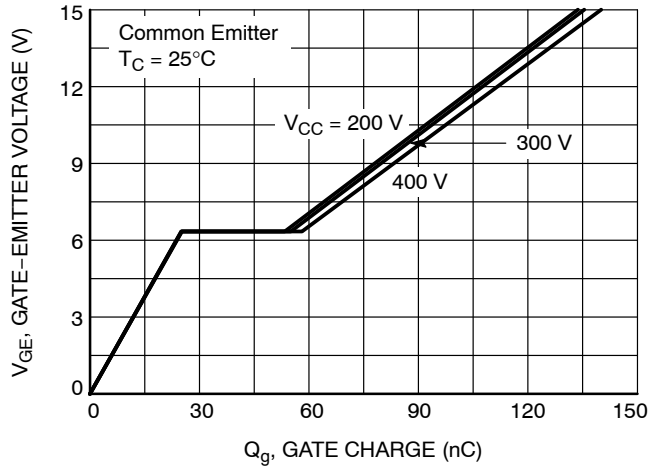

Figure 12. Gate Charge Characteristic (T_C = 25°C)

AFGHL75T65SQDC

TYPICAL CHARACTERISTICS

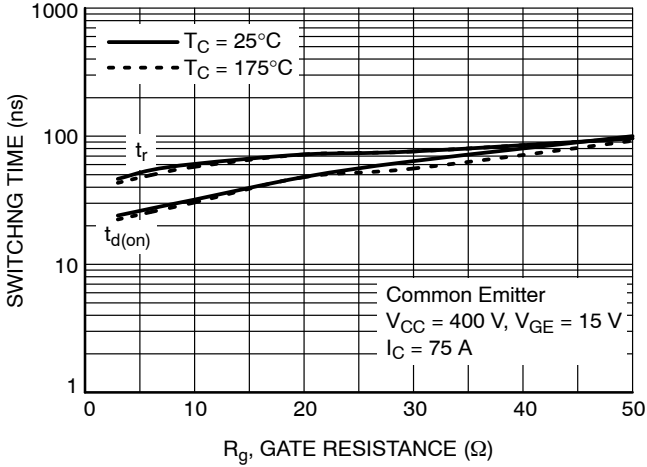

Figure 13. Turn-On Characteristics vs. Gate Resistance

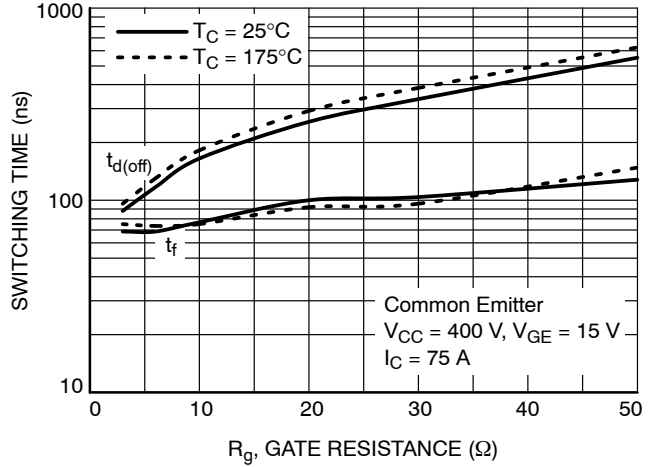

Figure 14. Turn-Off Characteristics vs. Gate Resistance

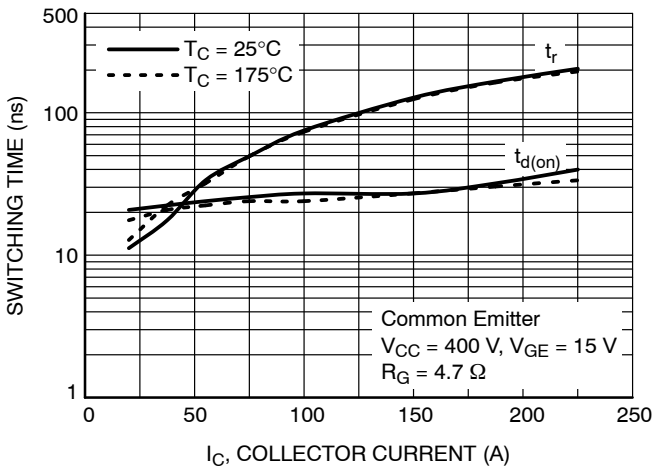

Figure 15. Turn-On Characteristics vs. Collector Current

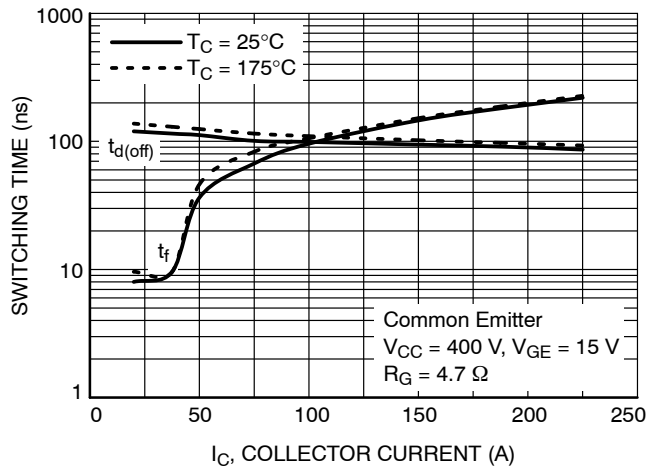

Figure 16. Turn-Off Characteristics vs. Collector Current

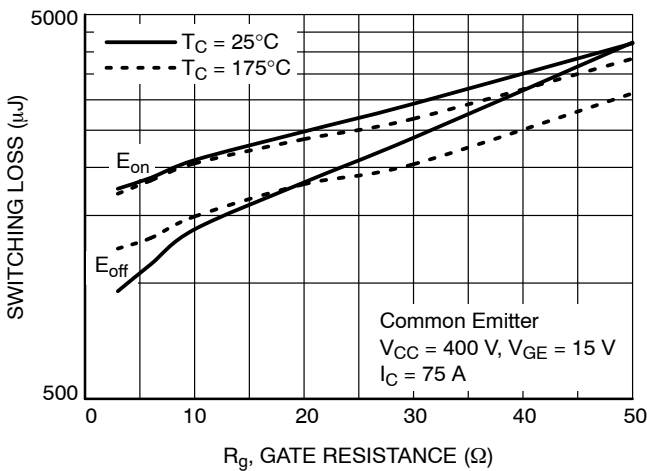

Figure 17. Switching Loss vs. Gate Resistance

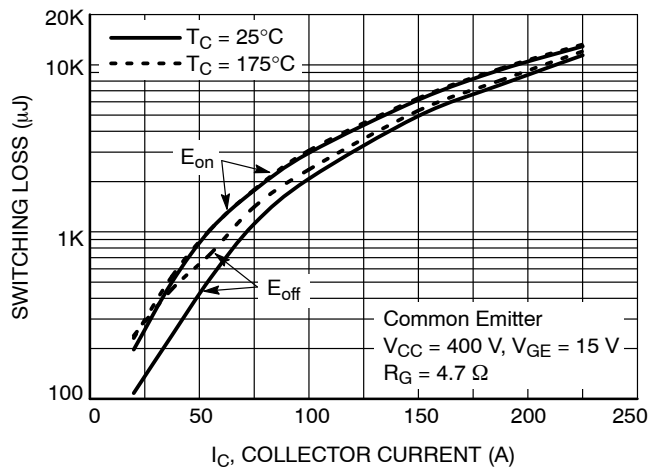

Figure 18. Switching Loss vs. Collector Current

AFGHL75T65SQDC

TYPICAL CHARACTERISTICS

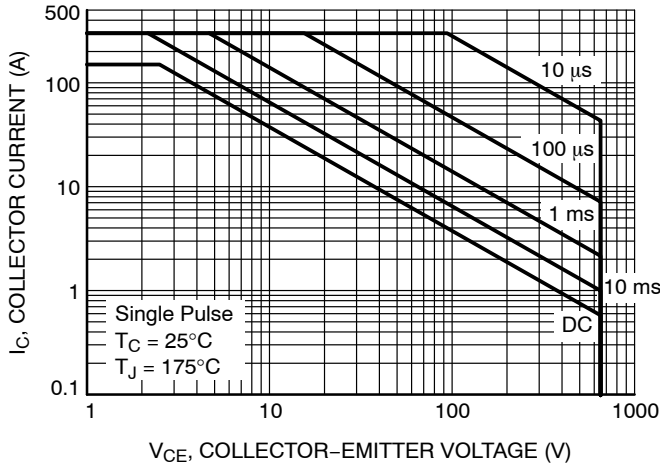

Figure 19. SOA Characteristics (FBSOA)

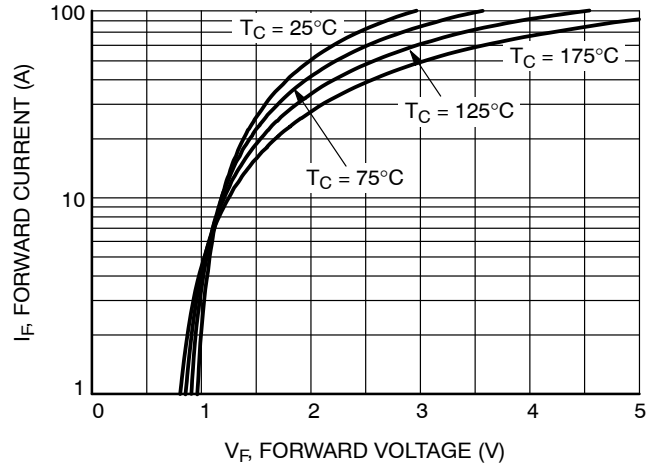

Figure 20. (Diode) Forward Characteristics vs. (Normal I-V)

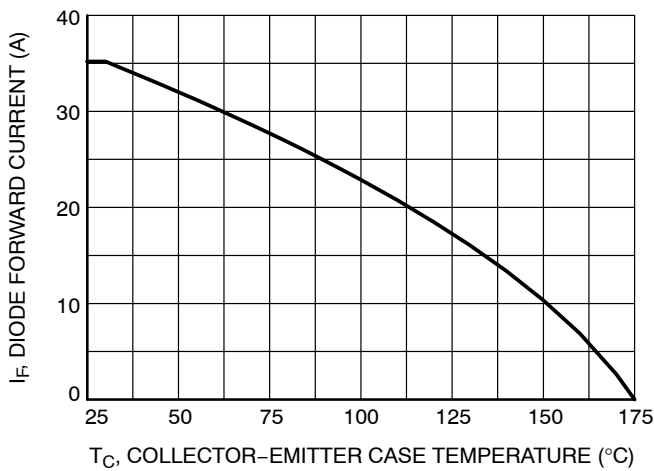

Figure 21. (Diode) Forward Current Derating

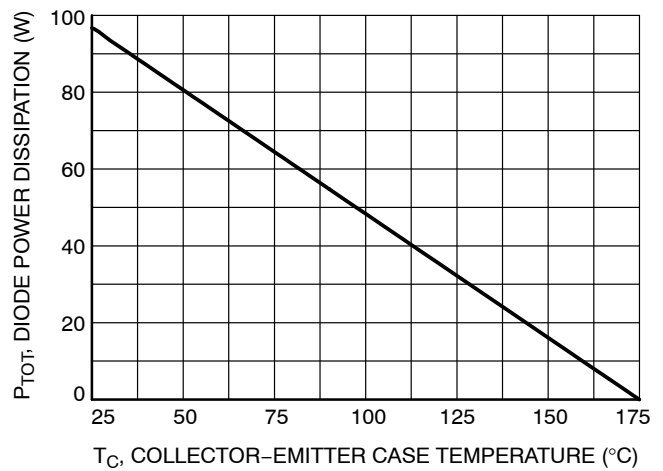

Figure 22. (Diode) Power Derating

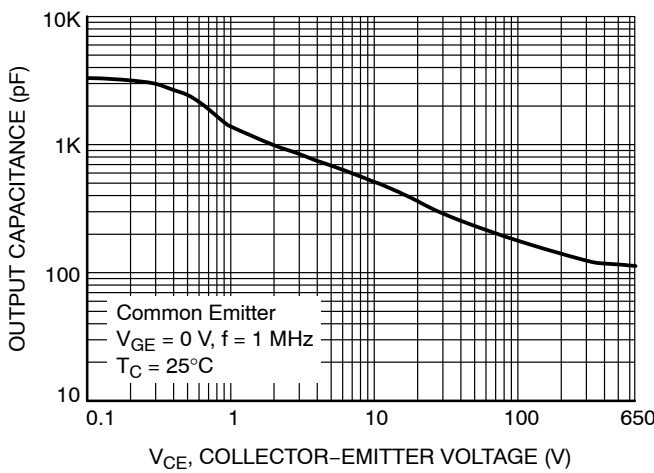

Figure 23. (Diode) Output Capacitance (Coes) vs. Reverse Voltage

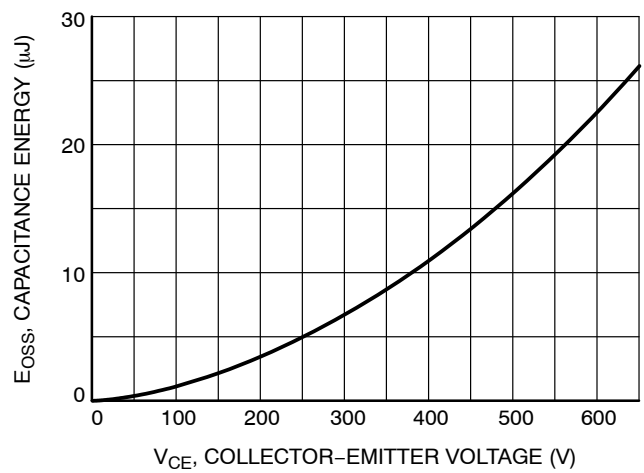

Figure 24. (Diode) Output Capacitance Stored Energy

AFGHL75T65SQDC

TYPICAL CHARACTERISTICS

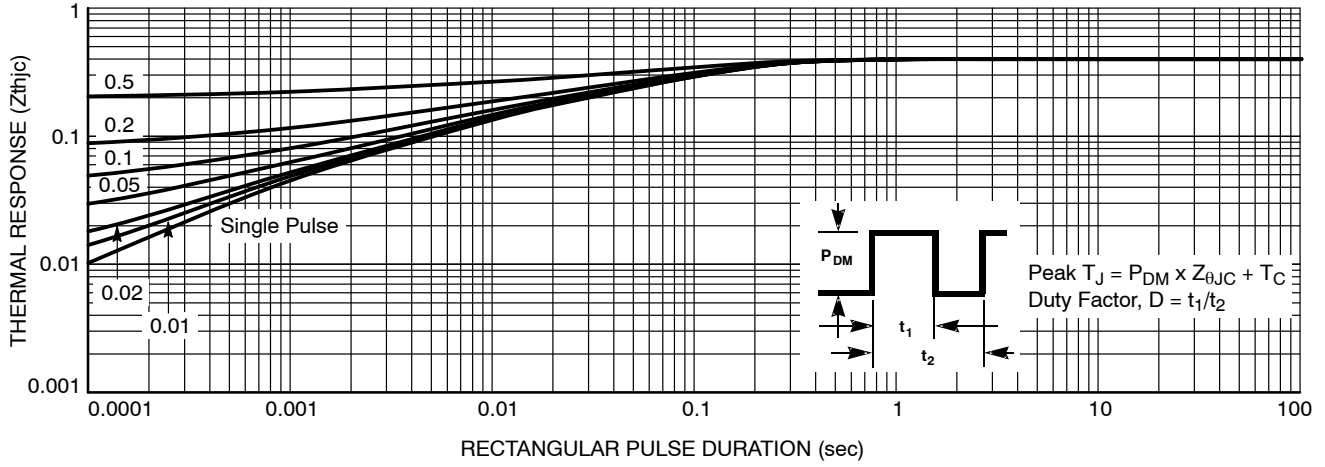

Figure 25. Transient Thermal Impedance of IGBT

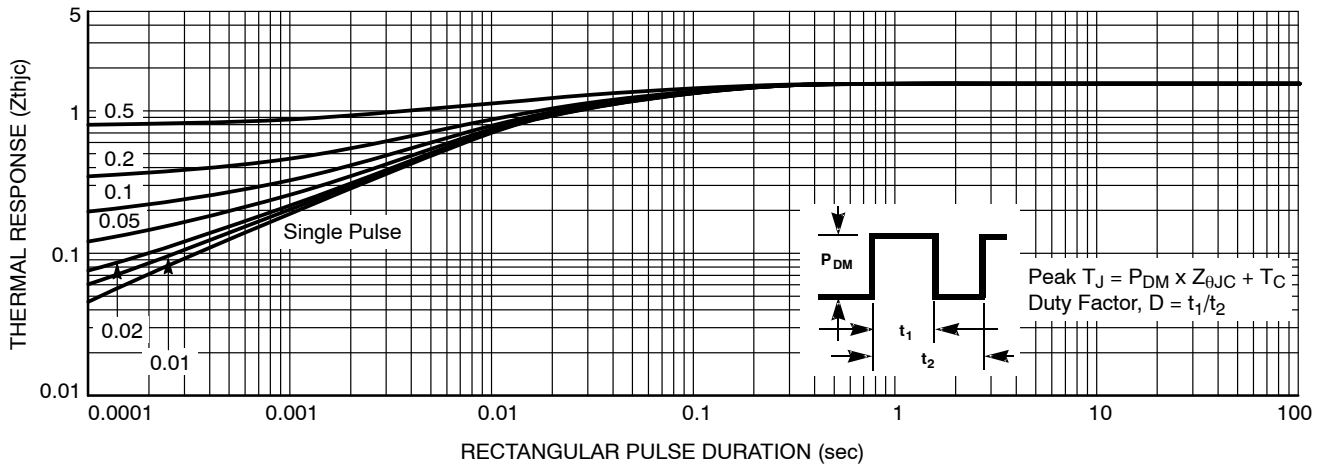

Figure 26. Transient Thermal Impedance of Diode

MECHANICAL CASE OUTLINE

PACKAGE DIMENSIONS

ON Semiconductor®



TO-247-3LD
CASE 340CX
ISSUE A

DATE 06 JUL 2020

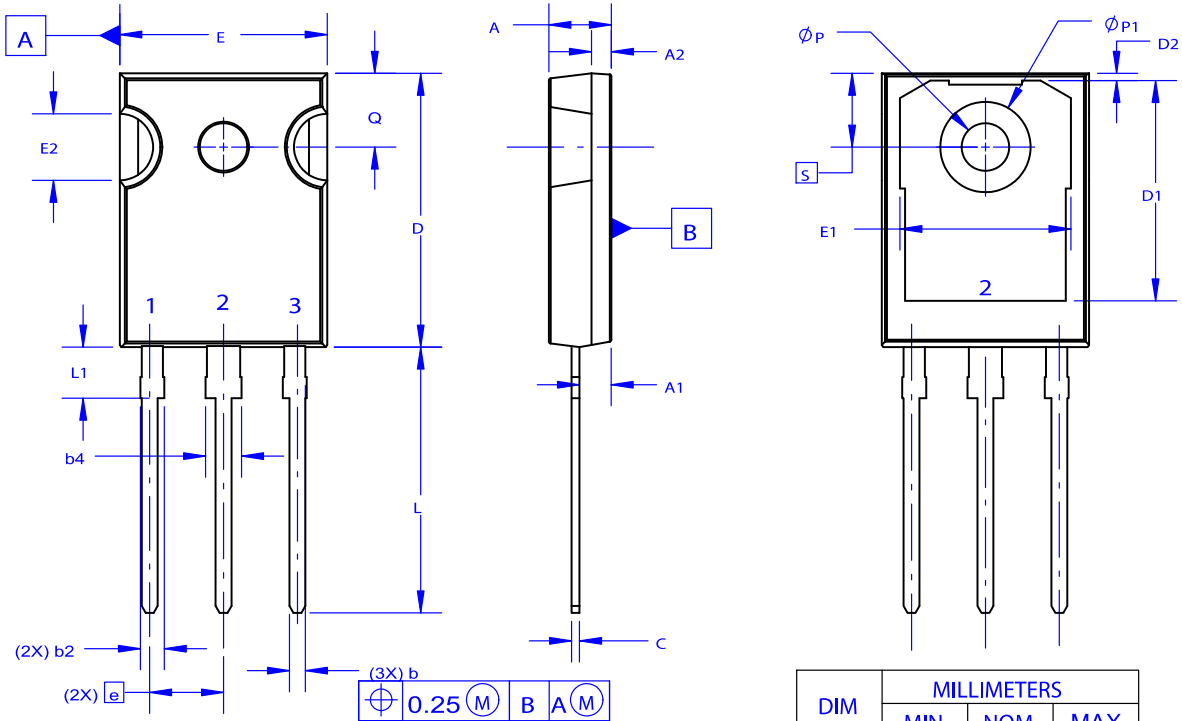
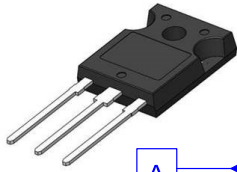

NOTES: UNLESS OTHERWISE SPECIFIED.

- A. DIMENSIONS ARE EXCLUSIVE OF BURRS, MOLD FLASH, AND TIE BAR EXTRUSIONS.
- B. ALL DIMENSIONS ARE IN MILLIMETERS.
- C. DRAWING CONFORMS TO ASME Y14.5 - 2009.
- D. DIMENSION A1 TO BE MEASURED IN THE REGION DEFINED BY L1.
- E. LEAD FINISH IS UNCONTROLLED IN THE REGION DEFINED BY L1.

DIM	MILLIMETERS		
	MIN	NOM	MAX
A	4.58	4.70	4.82
A1	2.20	2.40	2.60
A2	1.40	1.50	1.60
D	20.32	20.57	20.82
E	15.37	15.62	15.87
E2	4.96	5.08	5.20
e	~	5.56	~
L	19.75	20.00	20.25
L1	3.69	3.81	3.93
ØP	3.51	3.58	3.65
Q	5.34	5.46	5.58
S	5.34	5.46	5.58
b	1.17	1.26	1.35
b2	1.53	1.65	1.77
b4	2.42	2.54	2.66
c	0.51	0.61	0.71
D1	13.08	~	~
D2	0.51	0.93	1.35
E1	12.81	~	~
ØP1	6.60	6.80	7.00

GENERIC MARKING DIAGRAM*



- XXXXX = Specific Device Code
- A = Assembly Location
- Y = Year
- WW = Work Week
- G = Pb-Free Package

*This information is generic. Please refer to device data sheet for actual part marking. Pb-Free indicator, "G" or microdot "▪", may or may not be present. Some products may not follow the Generic Marking.

DOCUMENT NUMBER:	98AON93302G	Electronic versions are uncontrolled except when accessed directly from the Document Repository. Printed versions are uncontrolled except when stamped "CONTROLLED COPY" in red.
DESCRIPTION:	TO-247-3LD	PAGE 1 OF 1

ON Semiconductor and are trademarks of Semiconductor Components Industries, LLC dba ON Semiconductor or its subsidiaries in the United States and/or other countries. ON Semiconductor reserves the right to make changes without further notice to any products herein. ON Semiconductor makes no warranty, representation or guarantee regarding the suitability of its products for any particular purpose, nor does ON Semiconductor assume any liability arising out of the application or use of any product or circuit, and specifically disclaims any and all liability, including without limitation special, consequential or incidental damages. ON Semiconductor does not convey any license under its patent rights nor the rights of others.

onsemi, **Onsemi**, and other names, marks, and brands are registered and/or common law trademarks of Semiconductor Components Industries, LLC dba "**onsemi**" or its affiliates and/or subsidiaries in the United States and/or other countries. **onsemi** owns the rights to a number of patents, trademarks, copyrights, trade secrets, and other intellectual property. A listing of **onsemi**'s product/patent coverage may be accessed at www.onsemi.com/site/pdf/Patent-Marking.pdf. **onsemi** reserves the right to make changes at any time to any products or information herein, without notice. The information herein is provided "as-is" and **onsemi** makes no warranty, representation or guarantee regarding the accuracy of the information, product features, availability, functionality, or suitability of its products for any particular purpose, nor does **onsemi** assume any liability arising out of the application or use of any product or circuit, and specifically disclaims any and all liability, including without limitation special, consequential or incidental damages. Buyer is responsible for its products and applications using **onsemi** products, including compliance with all laws, regulations and safety requirements or standards, regardless of any support or applications information provided by **onsemi**. "Typical" parameters which may be provided in **onsemi** data sheets and/or specifications can and do vary in different applications and actual performance may vary over time. All operating parameters, including "Typicals" must be validated for each customer application by customer's technical experts. **onsemi** does not convey any license under any of its intellectual property rights nor the rights of others. **onsemi** products are not designed, intended, or authorized for use as a critical component in life support systems or any FDA Class 3 medical devices or medical devices with a same or similar classification in a foreign jurisdiction or any devices intended for implantation in the human body. Should Buyer purchase or use **onsemi** products for any such unintended or unauthorized application, Buyer shall indemnify and hold **onsemi** and its officers, employees, subsidiaries, affiliates, and distributors harmless against all claims, costs, damages, and expenses, and reasonable attorney fees arising out of, directly or indirectly, any claim of personal injury or death associated with such unintended or unauthorized use, even if such claim alleges that **onsemi** was negligent regarding the design or manufacture of the part. **onsemi** is an Equal Opportunity/Affirmative Action Employer. This literature is subject to all applicable copyright laws and is not for resale in any manner.

PUBLICATION ORDERING INFORMATION

LITERATURE FULFILLMENT:

Email Requests to: orderlit@onsemi.com

onsemi Website: www.onsemi.com

TECHNICAL SUPPORT

North American Technical Support:

Voice Mail: 1 800-282-9855 Toll Free USA/Canada

Phone: 011 421 33 790 2910

Europe, Middle East and Africa Technical Support:

Phone: 00421 33 790 2910

For additional information, please contact your local Sales Representative