



∅92×38 mm

San Ace 92RF 9RF type

General Specifications

- Material Frame: Plastic (Flammability: UL 94V-0), Impeller: Plastic (Flammability: UL 94V-0)
- Expected life See the table below. (L10 life: 90% survival rate for continuous operation in free air at 60°C, rated voltage)
- Motor protection function Locked rotor burnout protection, Reverse polarity protection
For details, please refer to p. 547.
- Dielectric strength 50/60 Hz, 500 VAC, for 1 minute (between lead wire conductors and frame)
- Insulation resistance 10 MΩ or more with a 500 VDC megger (between lead wire conductors and frame)
- Sound pressure level (SPL) At 1 m away from the air inlet
- Storage temperature -30 to +70°C (Non-condensing)
- Lead wire ⊕Red ⊖Black (Sensor) Yellow (Control) Brown
- Mass 150 g

Specifications

The models listed below **have pulse sensors with PWM control function.**

Model no.	Airflow direction	Rated voltage [V]	Operating voltage range [V]	PWM duty cycle* [%]	Rated current [A]	Rated input [W]	Rated speed [min ⁻¹]	Max. airflow [m ³ /min] [CFM]	Max. static pressure [Pa] [inchH ₂ O]	SPL [dB (A)]	Operating temperature [°C]	Expected life [h]
9RF0912P1H001	Forward	12	10.2 to 13.8	100	0.17	2.0	5500	1.2 42.4	156 0.63	39	-20 to +70	40000/60°C (70000/40°C)
	Reverse			0								
9RF0924P1H001	Forward	24	20.4 to 27.6	100	0.09	2.2	5500	1.2 42.4	156 0.63	39		
	Reverse			0								

* PWM frequency: 25 kHz

Airflow - Static Pressure Characteristics / PWM Duty - Speed Characteristics Example

9RF0912P1H001 With pulse sensor with PWM control function

Operating voltage range

Operating voltage range

PWM duty - Speed characteristics example

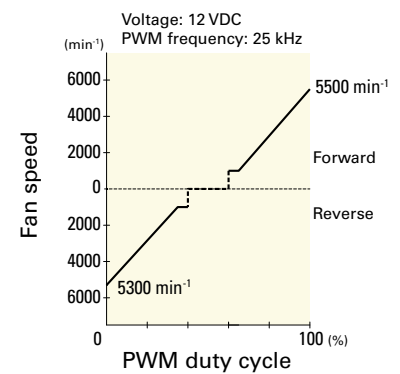
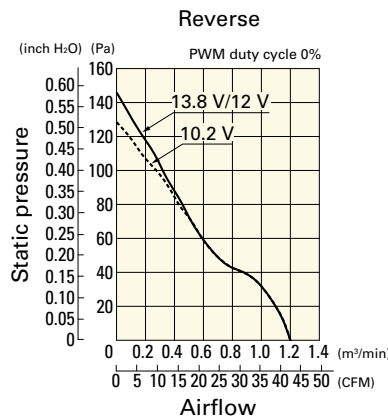
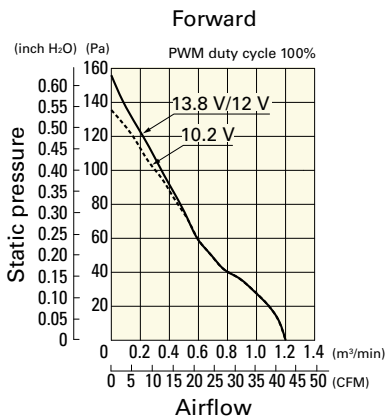

Airflow - Static Pressure Characteristics / PWM Duty - Speed Characteristics Example

9RF0924P1H001 With pulse sensor with PWM control function

Operating voltage range

Operating voltage range

PWM duty - Speed characteristics example

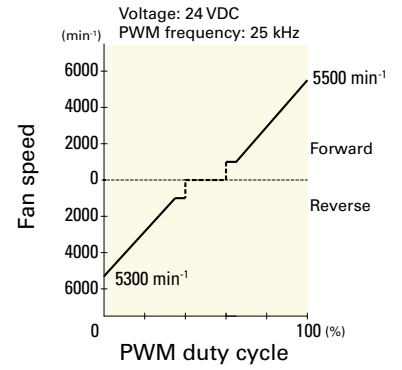
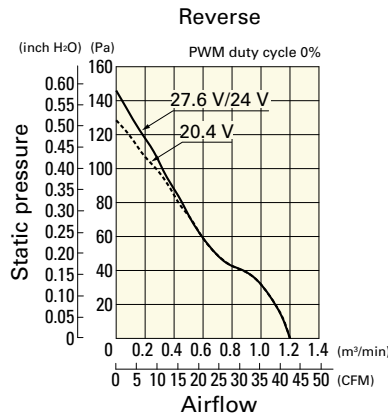
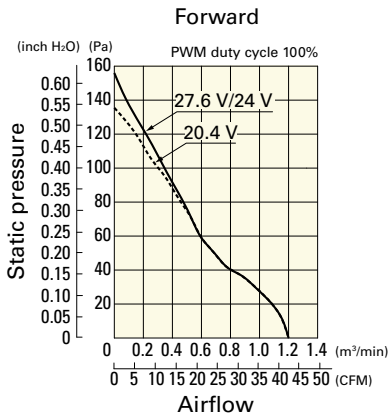

Dimensions (unit: mm)

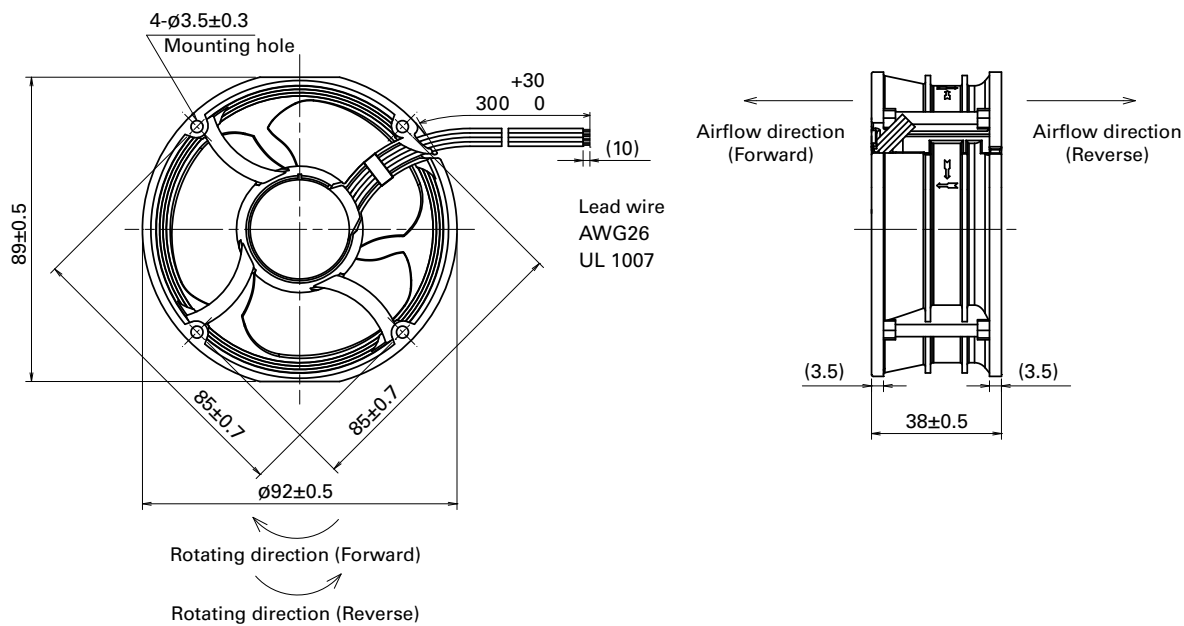

Reference Dimensions of Mounting Holes and Vent Opening (unit: mm)

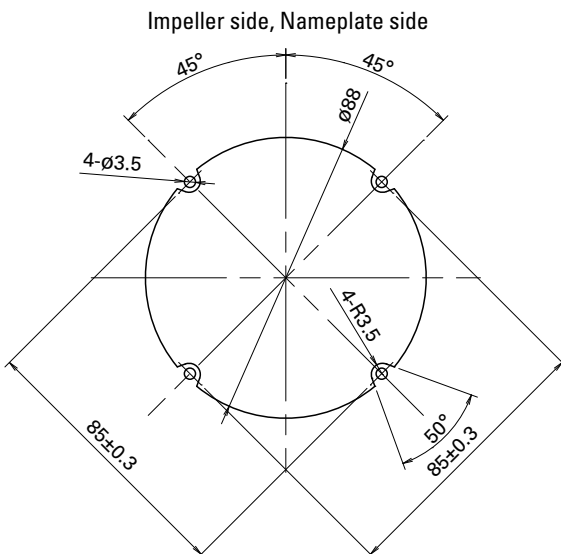

Options

Finger guards

page: p. 532

Model no.: 109-1147

DC
Reversible Flow Fan ϕ 92 mm

Mouser Electronics

Authorized Distributor

Click to View Pricing, Inventory, Delivery & Lifecycle Information:

Sanyo Denki:

[9RF0912P1H001](#) [9RF0924P1H001](#)