



SENSITIVE GATE TRIACS

- GLASS PASSIVATED CHIP
- HIGH SURGE CURRENT

DESCRIPTION

Low power triacs suited for 50 and 60 Hz up to 380 V_{RMS}.

APPLICATIONS

- CONTROL SPEED FOR LITTLE MOTORS ;
ELECTRIC PUMP OR VENTILATOR, SEWING MACHINE
- RELAY, DETECTOR, ALARM SYSTEM
- ELECTRONIC STARTER FOR LAMP
- HIGH POWER TRIAC DRIVER

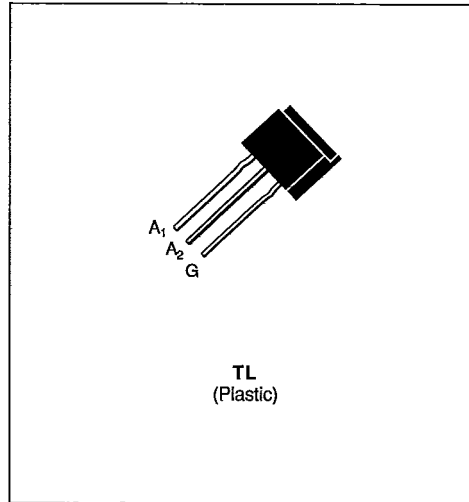

ABSOLUTE RATINGS (limiting values)

Symbol	Parameter	Value	Unit	
$I_{T(RMS)}$	RMS on-state Current (360° conduction angle)	$T_1 = 40\text{ °C}$ 1	A	
$I_{T(RMS)}$	RMS on-state Current on Printed Circuit (360° conduction angle)	$T_a = 25\text{ °C}$ 0.77	A	
I_{TSM}	Non Repetitive Surge Peak on-state Current (T_j initial = 25 °C - Half sine wave)	$t = 8.3\text{ ms}$	16	A
		$t = 10\text{ ms}$	15	
I^2t	I^2t Value for Fusing	$t = 10\text{ ms}$	1.125	A ² s
di/dt	Critical Rate of Rise of on-state Current (1)	Repetitive	10	A/ μ s
T_{stg} T_j	Storage and Operating Junction Temperature Range	- 40 to 150 - 40 to 110	°C °C	

Symbol	Parameter	TLC111S	TLC221S	TLC331S	TLC381S	Unit
V_{DRM}	Repetitive Peak off-state Voltage (2)	200	400	600	700	V

(1) $I_G = 100\text{ mA}$ $di/dt = 1\text{ A}/\mu\text{s}$
(2) $T_1 = 110\text{ °C}$.

THERMAL RESISTANCES

Symbol	Parameter	Value	Unit
$R_{th(j-a)}$	Junction to Ambient on Printed Circuit	75	°C/W
$R_{th(j-l)}$	Junction-leads for 360° Conduction Angle (F = 50 Hz)	45	°C/W

GATE CHARACTERISTICS (maximum values)

$P_{GM} = 2 \text{ W}$ ($t_p = 10 \mu\text{s}$) $I_{GM} = 1 \text{ A}$ ($t_p = 10 \mu\text{s}$)
 $P_{G(AV)} = 0.1 \text{ W}$ $V_{GM} = 16 \text{ V}$ ($t_p = 10 \mu\text{s}$)

T-25-13

ELECTRICAL CHARACTERISTICS

Symbol	Test Conditions	Quadrants	Min.	Typ.	Max.	Unit
I_{GT}	$T_j = 25 \text{ }^\circ\text{C}$ $V_D = 12 \text{ V}$ $R_L = 33 \text{ } \Omega$ Pulse Duration > 20 μs	I-II-III-IV			10	mA
V_{GT}	$T_j = 25 \text{ }^\circ\text{C}$ $V_D = 12 \text{ V}$ $R_L = 33 \text{ } \Omega$ Pulse Duration > 20 μs	I-II-III-IV			1.5	V
V_{GD}	$T_j = 110 \text{ }^\circ\text{C}$ $V_D = V_{DRM}$ $R_L = 3.3 \text{ k}\Omega$	I-II-III-IV	0.2			V
I_H^*	$T_j = 25 \text{ }^\circ\text{C}$ $I_T = 100 \text{ mA}$ Gate Open				25	mA
I_L	$T_j = 25 \text{ }^\circ\text{C}$ $V_D = 12 \text{ V}$ $I_G = 20 \text{ mA}$ Pulse Duration > 20 μs	I-II-III-IV			25	mA
V_{TM}^*	$T_j = 25 \text{ }^\circ\text{C}$ $I_{TM} = 1.4 \text{ A}$ $t_p = 10 \text{ ms}$				1.8	V
I_{DRM}^*	V_{DRM} Specified				0.01	mA
					0.75	
dv/dt^*	$T_j = 110 \text{ }^\circ\text{C}$ Gate Open Linear Slope up to $V_D = 67 \text{ } \% V_{DRM}$				20	V/ μs
$(dv/dt)_c^*$	$T_j = 40 \text{ }^\circ\text{C}$ $V_D = V_{DRM}$ $I_T = 1.4 \text{ A}$ $(di/dt)_c = 0.4 \text{ A/ms}$				5	V/ μs
t_{gt}	$T_j = 25 \text{ }^\circ\text{C}$ $V_D = V_{DRM}$ $I_T = 1.4 \text{ A}$ $I_G = 100 \text{ mA}$ $di_G/dt = 1 \text{ A}/\mu\text{s}$	I-II-III-IV			3	μs

* For either polarity of electrode A₂ voltage with reference to electrode A₁.

PACKAGE MECHANICAL DATA

TL Plastic

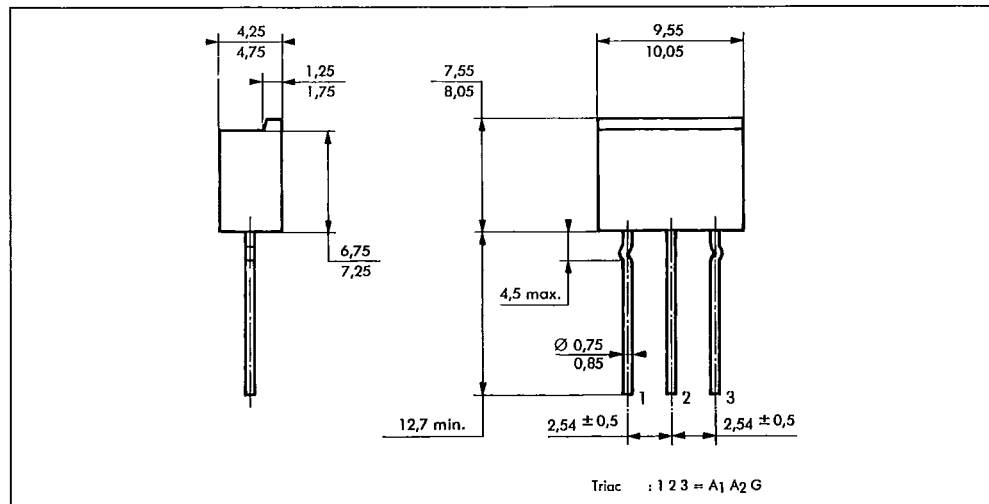

Cooling method : by convection (method A)
 Marking : type number
 Weight : 0.8 g.

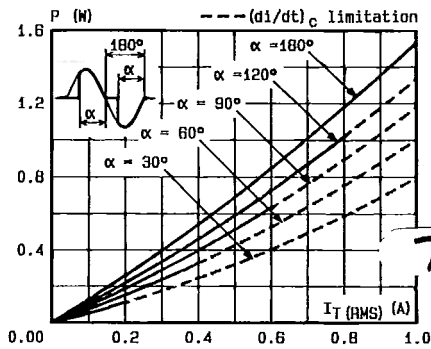

Fig. 1 - Maximum mean power dissipation versus RMS on-state current ($F = 60 \text{ Hz}$).

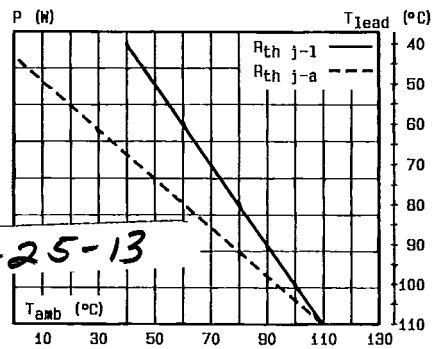

Fig. 2 - Correlation between maximum mean power dissipation and maximum allowable temperatures (T_{amb} and T_{lead}) - resistances heatsink + contact.

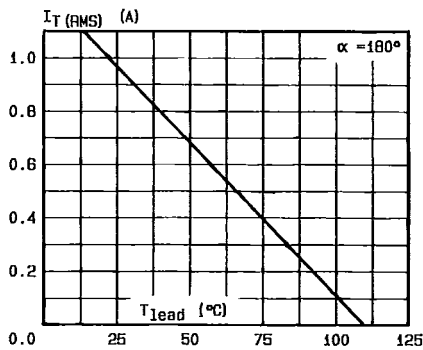

Fig. 3 - RMS on-state current versus lead temperature.

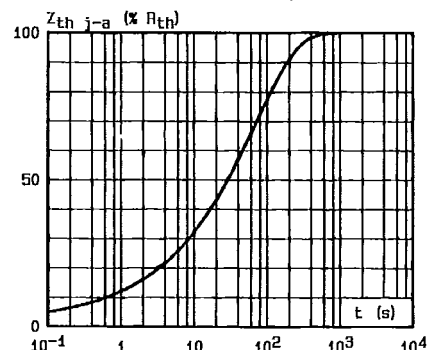

Fig. 4 - Thermal transient impedance junction to ambient versus pulse duration.

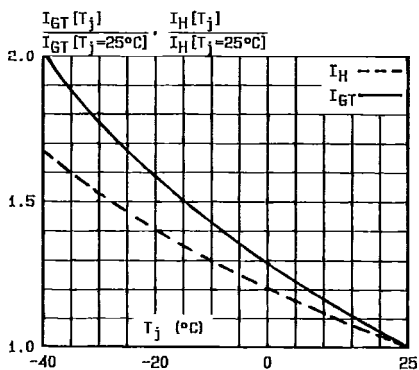

Fig. 5 - Relative variation of gate trigger current and holding current versus junction temperature.

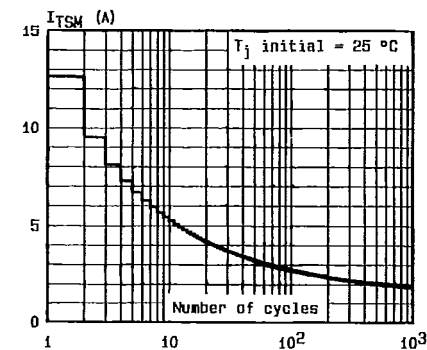

Fig. 6 - Non repetitive surge peak on state current versus number of cycles.

T-25-13

SG S-THOMSON

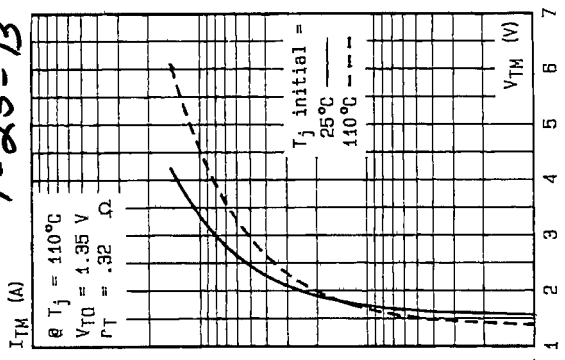

Fig. 8 - On-state characteristics (maximum values).

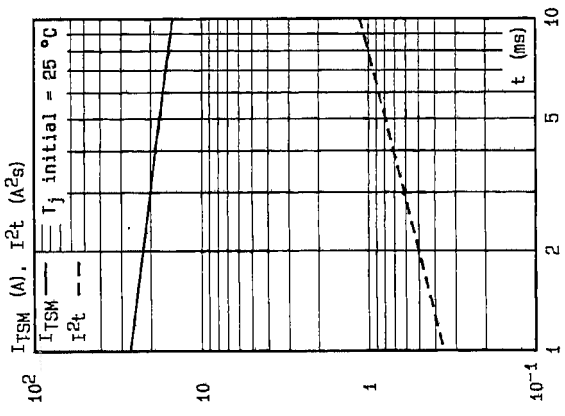

Fig. 7 - Non repetitive surge peak on-state current for a sinusoidal pulse with width: $t \leq 40$ ms, and corresponding value of I^2t .