

# 100 MHz Analog Oscilloscope HM1000

Manual

English

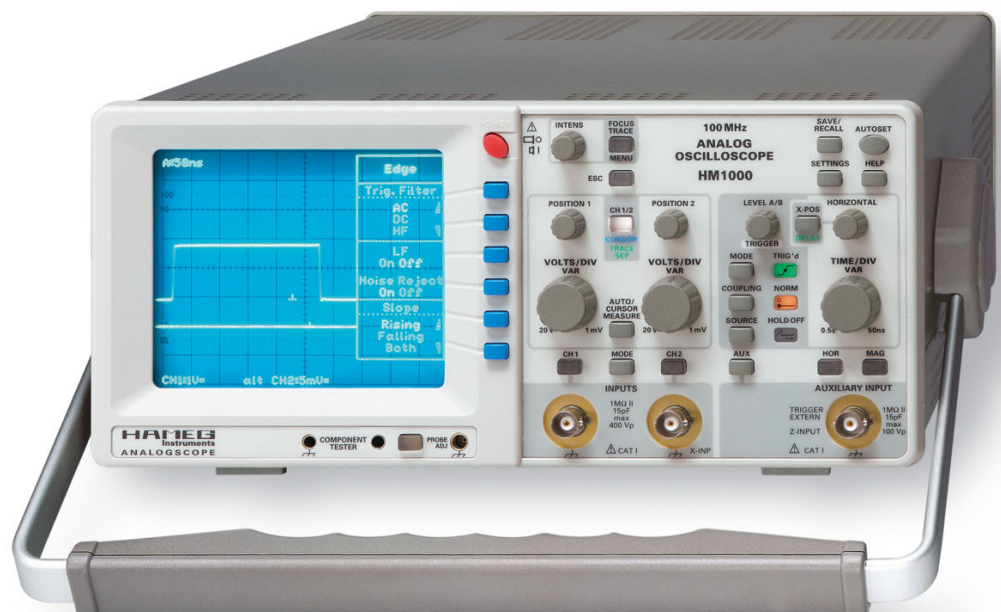



Hersteller  
Manufacturer  
Fabricant

HAMEG Instruments GmbH  
Industriestraße 6  
D-63533 Mainhausen

KONFORMITÄTSERKLÄRUNG  
DECLARATION OF CONFORMITY  
DECLARATION DE CONFORMITE



Die HAMEG Instruments GmbH bescheinigt die Konformität für das Produkt  
The HAMEG Instruments GmbH herewith declares conformity of the product  
HAMEG Instruments GmbH déclare la conformité du produit

Bezeichnung / Product name / Designation:

Oszilloskop  
Oscilloscope  
Oscilloscope

Typ / Type / Type:

HM1000

mit / with / avec:

-

Optionen / Options / Options:

-

mit den folgenden Bestimmungen / with applicable regulations / avec les directives suivantes

EMV Richtlinie 89/336/EWG ergänzt durch 91/263/EWG, 92/31/EWG  
EMC Directive 89/336/EEC amended by 91/263/EWG, 92/31/EEC  
Directive EMC 89/336/CEE amendée par 91/263/EWG, 92/31/CEE

Niederspannungsrichtlinie 73/23/EWG ergänzt durch 93/68/EWG  
Low-Voltage Equipment Directive 73/23/EEC amended by 93/68/EEC  
Directive des équipements basse tension 73/23/CEE amendée par 93/68/CEE

Angewendete harmonisierte Normen / Harmonized standards applied / Normes harmonisées utilisées:

Sicherheit / Safety / Sécurité: EN 61010-1:2001 (IEC 61010-1:2001)  
Überspannungskategorie / Overvoltage category / Catégorie de surtension: II  
Verschmutzungsgrad / Degree of pollution / Degré de pollution: 2

Elektromagnetische Verträglichkeit / Electromagnetic compatibility /  
Compatibilité électromagnétique

EN 61326-1/A1 Störaussendung / Radiation / Emission:  
Tabelle / table / tableau 4; Klasse / Class / Classe B.

Störfestigkeit / Immunity / Imunité: Tabelle / table / tableau A1.

EN 61000-3-2/A14 Oberschwingungsströme / Harmonic current emissions /  
Émissions de courant harmonique:  
Klasse / Class / Classe D.

EN 61000-3-3 Spannungsschwankungen u. Flicker / Voltage fluctuations and flicker /  
Fluctuations de tension et du flicker.

Datum /Date /Date  
24. 02. 2005

Unterschrift / Signature / Signatur

  
Manuel Roth  
Manager

## General information regarding the CE marking

HAMEG instruments fulfill the regulations of the EMC directive. The conformity test made by HAMEG is based on the actual generic- and product standards. In cases where different limit values are applicable, HAMEG applies the severer standard. For emission the limits for residential, commercial and light industry are applied. Regarding the immunity (susceptibility) the limits for industrial environment have been used.

The measuring- and data lines of the instrument have much influence on emission and immunity and therefore on meeting the acceptance limits. For different applications the lines and/or cables used may be different. For measurement operation the following hints and conditions regarding emission and immunity should be observed:

### 1. Data cables

For the connection between instruments resp. their interfaces and external devices, (computer, printer etc.) sufficiently screened cables must be used. Without a special instruction in the manual for a reduced cable length, the maximum cable length of a dataline must be less than 3 meters and not be used outside buildings. If an interface has several connectors only one connector must have a connection to a cable.

Basically interconnections must have a double screening. For IEEE-bus purposes the double screened cables HZ72S and HZ72L from HAMEG are suitable.

### 2. Signal cables

Basically test leads for signal interconnection between test point and instrument should be as short as possible. Without instruction in the manual for a shorter length, signal lines must be less than 3 meters and not be used outside buildings.

Signal lines must be screened (coaxial cable - RG58/U). A proper ground connection is required. In combination with signal generators double screened cables (RG223/U, RG214/U) must be used.

## 3. Influence on measuring instruments

Under the presence of strong high frequency electric or magnetic fields, even with careful setup of the measuring equipment an influence of such signals is unavoidable.

This will not cause damage or put the instrument out of operation. Small deviations of the measuring value (reading) exceeding the instruments specifications may result from such conditions in individual cases.

## 4. RF immunity of oscilloscopes.

### 4.1 Electromagnetic RF field

The influence of electric and magnetic RF fields may become visible (e.g. RF superimposed), if the field intensity is high. In most cases the coupling into the oscilloscope takes place via the device under test, mains/line supply, test leads, control cables and/or radiation. The device under test as well as the oscilloscope may be effected by such fields.

Although the interior of the oscilloscope is screened by the cabinet, direct radiation can occur via the CRT gap. As the bandwidth of each amplifier stage is higher than the total -3dB bandwidth of the oscilloscope, the influence RF fields of even higher frequencies may be noticeable.

### 4.2 Electrical fast transients / electrostatic discharge

Electrical fast transient signals (burst) may be coupled into the oscilloscope directly via the mains/line supply, or indirectly via test leads and/or control cables. Due to the high trigger and input sensitivity of the oscilloscopes, such normally high signals may effect the trigger unit and/or may become visible on the CRT, which is unavoidable. These effects can also be caused by direct or indirect electrostatic discharge.

HAMEG Instruments GmbH

<b>General information regarding the CE marking</b>	<b>2</b>	<b>AUTOSET</b>	<b>19</b>
<b>100 MHz 2-Chanel Analog Oscilloscope HM1000</b>	<b>4</b>	<b>Component tester</b>	<b>19</b>
<b>Specifications</b>	<b>5</b>	<b>General information concerning MENU</b>	<b>21</b>
<b>Important hints</b>	<b>6</b>	<b>Controls and Readout</b>	<b>22</b>
List of symbols used:	6		
Positioning the instrument	6		
Safety	6		
Proper operation	6		
CAT I	6		
Environment of use.	6		
Environmental conditions	7		
Warranty and repair	7		
Maintenance	7		
Line voltage	7		
<b>Description of the controls</b>	<b>8</b>		
<b>Basic signal measurement</b>	<b>10</b>		
Signals which can be measured	10		
Amplitude of signals	10		
Values of a sine wave signal	10		
DC and ac components of an input signal	11		
Timing relationships	11		
Connection of signals	11		
<b>First time operation and initial adjustments</b>	<b>12</b>		
Trace rotation TR	12		
Probe adjustment and use	12		
1 kHz adjustment	12		
1 MHz adjustment	13		
<b>Operating modes of the vertical amplifier</b>	<b>13</b>		
XY operation	14		
Phase measurements with Lissajous figures	14		
Measurement of phase differences in dual channel Yt mode	14		
Measurement of amplitude modulation	15		
<b>Triggering and time base</b>	<b>15</b>		
Automatic peak triggering (MODE menu)	15		
Normal trigger mode (See menu MODE)	16		
Slope selection (Menu FILTER)	16		
Trigger coupling (Menu: FILTER)	16		
Video (tv triggering)	16		
Frame sync pulse triggering	17		
Line sync pulse triggering	17		
LINE trigger	17		
Alternate trigger	17		
External triggering	17		
Indication of triggered operation (TRIG'D LED)	17		
Hold-off time adjustment	17		
Time base B (2nd time base). Delaying, Delayed Sweep	18		
Alternate sweep	18		

# 100 MHz Analog Oscilloscope HM1000

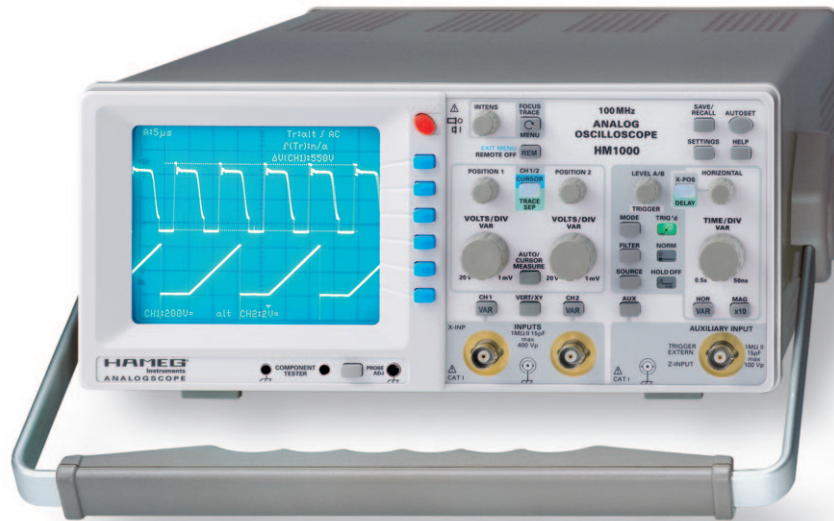

Undistorted display of a  
100 MHz sine wave signal

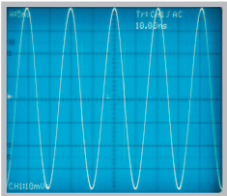

Lissajous Figure (XY Mode)

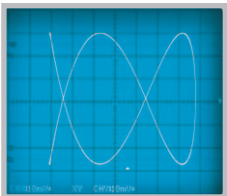

Two asynchronous signals  
triggered by alternate  
triggering

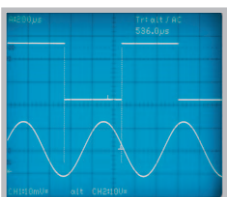

Two Channels with deflection coefficients of 1 mV – 20 V/cm

Low Noise Measuring Amplifiers with high pulse fidelity

Two Time Bases: 0.5 s – 5 ns/cm and 20 ms – 5 ns/cm

Videotrigger: Odd and even frames, line selection (525/60 and  
625/50 standard)

200 MHz 6-Digit Frequency Counter, Cursor and Automatic  
Measurement

14 kV high writing speed CRT, Readout, Autoset, Delay Line,  
no Fan

Save/Recall Memories for instrument settings

Help Function, Multilingual Menu



## 100 MHz Analog Oszilloscope HM1000

Valid at 23 °C after a 30 minute warm-up period

### Vertical Deflection

Channels:	2
Operating Modes:	CH 1 or CH 2 separate, DUAL (CH 1 and CH 2 alternate or chopped), Addition
X in XY-Mode:	CH 1
Invert:	CH 1, CH 2
Bandwidth [-3dB]:	2 x 0 - 100 MHz
Rise time:	< 3.5 ns
Overshoot:	max. 1%
Bandwidth limiting (selectable):	about 20 MHz (5 mV/cm - 20V/cm)
Deflection Coefficients(CH 1, 2):	14 calibrated steps
1 mV - 2 mV/cm:	± 5% (0 - 10 MHz [-3 dB])
5 mV - 20V/cm:	± 3% (1-2-5 sequence)
variable (uncalibrated):	> 2.5:1 to > 50V/cm
Inputs CH 1, 2:	
Impedance:	1 MΩ // 15 pF
Coupling:	DC, AC, GND (ground)
Max. Input Voltage:	400 V [DC + peak AC]
Y Delay Line:	70 ns
Measuring Circuits:	Measuring Category I
Auxiliary input:	
Function (selectable):	Extern Trigger, Z (unblank)
Coupling:	AC, DC
Max. input voltage:	100 V [DC + peak AC]

### Triggering

Automatic (Peak to Peak):	
Min. signal height:	5 mm
Frequency range:	10 Hz - 200 MHz
Level control range:	from Peak- to Peak+
Normal (without peak):	
Min. signal height:	5 mm
Frequency range:	0 - 200 MHz
Level control range:	-10 cm to +10 cm
Operating modes:	Slope/Video
Slope:	positive, negative, both
Sources:	CH 1, CH 2, alt. CH 1/2 (≥ 8 mm), Line, Ext.
Coupling:	AC: 10 Hz-200 MHz DC: 0-200 MHz HF: 30 kHz-200 MHz LF: 0-5 kHz Noise Rej. switchable
Video:	pos./neg. Sync. Impulse
Standards:	525 Line/60 Hz Systems 625 Line/50 Hz Systems
Field:	even/odd/both
Line:	all/line number selectable
Source:	CH 1, CH 2, Ext.
Indicator for trigger action:	LED
External Trigger via:	Auxiliary Input (0.3V <sub>pp</sub> , 100 MHz)
Coupling:	AC, DC
Max. input voltage:	100 V [DC +peak AC]
2nd Trigger	
Min. signal height:	5 mm
Frequency range:	0 - 200 MHz
Coupling:	DC
Level control range:	-10 cm to +10 cm

### Horizontal Deflection

Operating modes:	A, ALT (alternating A/B), B
Time base A:	0.5 s/cm - 50 ns/cm (1-2-5 sequence)
Time base B:	20 ms/cm - 50 ns/cm (1-2-5 sequence)
Accuracy A and B:	± 3%
X Magnification x10:	to 5 ns/cm
Accuracy:	± 5%
Variable time base A/B:	cont. 1:2.5
Hold Off time:	var. 1:10 LED-Indication
Bandwidth X-Amplifier:	0 - 3 MHz [-3 dB]
XY phase shift < 3°:	< 220 kHz help functions

### Operation/Measuring/Interfaces

Operation:	Autoset, Menu and help functions (multilingual)
Save/Recall (instrument parameter settings):	9
Signal display:	max. 4 traces CH 1, 2 (Time Base A) in combination with CH 1, 2 (Time Base B)

Frequency counter:	
6 digit resolution:	>1 MHz - 200 MHz
5 digit resolution:	0.5 Hz - 1 MHz
Accuracy:	50 ppm
Auto Measurements:	Frequency, Period, Vdc, Vpp, Vp+, Vp-
Cursor Measurements:	Δt, 1/Δt (f), t <sub>r</sub> , ΔV, V to GND, ratio X, ratio Y
Resolution Readout/Cursor:	1000 x 2000 Pts
Interfaces (plug-in):	RS-232 (H0710), Ethernet,
Optional:	Dual-Interface RS232/USB

### Display

CRT:	D14-375GH
Display area (with graticule):	8 cm x 10 cm
Acceleration voltage:	ca. 14 kV

### General Information

Component tester:	
Test voltage:	approx. 7V <sub>rms</sub> (open circuit), approx. 50 Hz
Test current:	max. 7 mA <sub>rms</sub> (short circuit)
Reference Potential:	Ground (safety earth)
Probe ADJ Output:	1 kHz/1 MHz square wave signal 0.2V <sub>pp</sub> (tr < 4 ns)
Trace rotation:	electronic
Line voltage:	105 - 253 V, 50/60 Hz ± 10%, CAT II
Power consumption:	37 Watt at 230 V, 50 Hz
Protective system:	Safety class I (EN61010-1)
Weight:	5.6 kg
Cabinet (W x H x D):	285 x 125 x 380 mm
Ambient temperature:	0° C ...+40° C

**Accessories supplied:** Line cord, Operating manual, 2 Probes 10:1 with attenuation ID

**Optional accessories:**  
H0720 Dual-Interface RS-232/USB  
H0730 Dual-Interface Ethernet/USB  
H0740 Interface IEEE-488 (GPIB)  
HZ70 Opto-Interface (with optical fiber cable)

www.hameg.com

## Important hints

Please check the instrument for mechanical damage or loose parts immediately after unpacking. In case of damage we advise to contact the sender. Do not operate.

### List of symbols used:



Consult the manual



High voltage



Important note



Ground

### Positioning the instrument

For selection of the optimum position in use the instrument may be set up in three different positions (see pictures C,D,E). The handle will remain locked in the carrying position if the instrument is positioned on its rear feet.

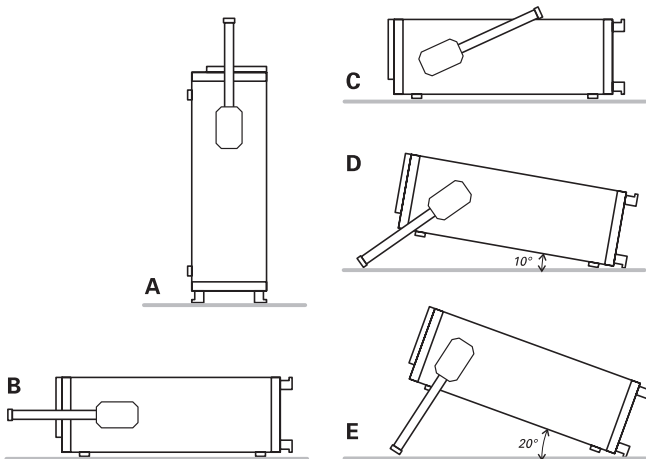

Move the handle to the instrument top if the horizontal operating position is preferred (See picture C). If a position corresponding the picture D (10 degrees inclination) is desired move the handle from the carrying position A towards the bottom until it engages and locks. In order to reach a position with still greater inclination (E shows 20 degrees) unlock the handle by pulling and move it further into the next locking position. For carrying the instrument in the horizontal position the handle can be locked horizontally by moving it upwards as shown in picture B. The instrument must be lifted while doing this, otherwise the handle will unlock again.

### Safety

The instrument fulfils the VDE 0411 part 1 regulations for electrical measuring, control and laboratory instruments and was manufactured and tested accordingly. It left the factory in perfect safe condition. Hence it also corresponds to European Standard EN 61010-1 resp. International Standard IEC 1010-1. In order to maintain this condition and to ensure safe operation the user is required to observe the warnings and other directions for use in this manual. Housing, chassis as well as all measuring terminals are connected to safety ground of the mains. All accessible metal parts were tested against the mains with 2200 V<sub>DC</sub>. The instrument conforms to safety class I.

The oscilloscope may only be operated from mains outlets with a safety ground connector. The plug has to be installed prior to

connecting any signals. It is prohibited to separate the safety ground connection.

Most electron tubes generate X rays; the ion dose rate of this instrument remains well below the 36 pA/kg permitted by law.

In case safe operation may not be guaranteed do not use the instrument any more and lock it away in a secure place.

### Safe operation may be endangered if any of the following was noticed:

- in case of visible damage.
- in case loose parts were noticed
- if it does not function any more.
- after prolonged storage under unfavourable conditions (e.g. like in the open or in moist atmosphere).
- after any improper transport (e.g. insufficient packing not conforming to the minimum standards of post, rail or transport firm)

### Proper operation

Please note: This instrument is only destined for use by personnel well instructed and familiar with the dangers of electrical measurements.

For safety reasons the oscilloscope may only be operated from mains outlets with safety ground connector. It is prohibited to separate the safety ground connection. The plug must be inserted prior to connecting any signals.

### CAT I

This oscilloscope is destined for measurements in circuits not connected to the mains or only indirectly. Direct measurements, i.e. with a galvanic connection to circuits corresponding to the categories II, III, or IV are prohibited!

The measuring circuits are considered not connected to the mains if a suitable isolation transformer fulfilling safety class II is used. Measurements on the mains are also possible if suitable probes like current probes are used which fulfil the safety class II. The measurement category of such probes must be checked and observed.

### Measurement categories

The measurement categories were derived corresponding to the distance from the power station and the transients to be expected hence. Transients are short, very fast voltage or current excursions which may be periodic or not.

Measurement cat. IV:

Measurements close to the power station, e.g. on electricity meters

Measurement cat. III:

Measurements in the interior of buildings (power distribution installations, mains outlets, motors which are permanently installed).

Measurement cat. II:

Measurements in circuits directly connected to the mains (household appliances, power tools etc).

### Environment of use.

The oscilloscope is destined for operation in industrial, business, manufacturing, and living sites.

## Environmental conditions

Operating ambient temperature: 0 to + 40 degrees C. During transport or storage the temperature may be -25 to +55 degrees C.

Please note that after exposure to such temperatures or in case of condensation proper time must be allowed until the instrument has reached the permissible range of 0 to + 40 degrees resp. until the condensation has evaporated before it may be turned on! Ordinarily this will be the case after 2 hours. The oscilloscope is destined for use in clean and dry environments. Do not operate in dusty or chemically aggressive atmosphere or if there is danger of explosion.

The operating position may be any, however, sufficient ventilation must be ensured (convection cooling). Prolonged operation requires the horizontal or inclined position.

 **Do not obstruct the ventilation holes!**

Specifications are valid after a 20 minute warm-up period between 15 and 30 degr. C. Specifications without tolerances are average values.

## Warranty and repair

HAMEG instruments are subjected to a rigorous quality control. Prior to shipment each instrument will be burnt-in for 10 hours. Intermittent operation will produce nearly all early failures. After burn-in a final functional and quality test will be performed which checks all operating modes and fulfilment of specifications.

In case of complaints within the 2 year warranty period please contact the distributor from which the instrument was bought. German customers may contact HAMEG directly. Our warranty policy may be obtained under [www.hameg.de](http://www.hameg.de). Of course, HAMEG customer service will be at your disposal also after expiration of the warranty.

### Return Material Authorization.

**Prior to sending an instrument please obtain a RMA number form HAMEG either via [www.hameg.de](http://www.hameg.de) or by fax. In case you do not have an original packing you may order one by contacting HAMEG marketing and sales by phone +49-6182-800-300 or under [vertrieb@hameg.de](mailto:vertrieb@hameg.de).**

## Maintenance

It is necessary to check various important properties of the oscilloscope regularly. Only this will ensure that all measurements will be exact within the instrument's specifications. We recommend a SCOPE TESTER HZ60 which, in spite of its low cost, will fulfil this requirement very well. Clean the outer shell using a dust brush in regular intervals. Dirt can be removed from housing, handle, all metal and plastic parts using a cloth moistened with water and 1 % detergent. Greasy dirt may be removed with benzene (petroleum ether) or alcohol, there after wipe the surfaces with a dry cloth. Plastic parts should be treated with an antistatic solution destined for such parts. No fluid may enter the instrument. Do not use other cleansing agents as they may adversely affect the plastic or lacquered surfaces.

## Line voltage

The instrument has a wide range power supply from 105 to 253 V, 50 or 60 Hz  $\pm 10\%$ . There is hence no line voltage selector.

The line fuse is accessible on the rear panel and part of the line input connector. Prior to exchanging a fuse the line cord must be pulled out. Exchange is only allowed if the fuse holder is undamaged, it can be taken out using a screwdriver put into the slot. The fuse can be pushed out of its holder and exchanged.

The holder with the new fuse can then be pushed back in place against the spring. It is prohibited to "repair" blown fuses or to bridge the fuse. Any damages incurred by such measures will void the warranty.

### Type of fuse:

Size 5 x 20 mm; 250V~, C;  
IEC 127, Bl. III; DIN 41 662  
(or DIN 41 571, Bl. 3).

Cut off: slow blow (T) 0,8A.

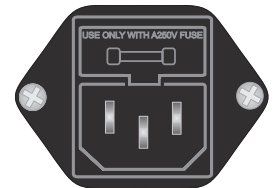

## Front Panel Elements – Brief Description

The figures indicate the page for complete descriptions in the chapter **CONTROLS AND READOUT** ▼

① <b>POWER</b> (pushbutton switch) 22 Turns scope on and off.	⑱ <b>SOURCE</b> (pushbutton switch) 27 Calls trigger source menu.
② <b>INTENS</b> (knob) 22 Intensity for trace- and readout brightness, focus and trace rotation control.	⑲ <b>TRIG'd</b> (LED) 28 Lit on condition that time base is triggered.
③ <b>FOCUS, TRACE, MENU</b> (pushbutton switch) 22 Calls the Intensity Knob menu to be displayed and enables the change of different settings by aid of the INTENS knob. See item 2.	⑳ <b>NORM</b> (LED) 28 Lit on condition that NORMAL or SINGLE triggering is present.
④ <b>REM</b> (pushbutton switch) 22 Switches the displayed menu, the remote mode (REM lit) off.	㉑ <b>HOLD OFF</b> (LED) 28 Lit if a hold off time > 0% is chosen in time base menu (HOR pushbutton ㉒).
⑤ <b>SAVE/RECALL</b> (pushbutton switch) 23 Offers access to the instrument settings memory.	㉒ <b>X-POS / DELAY</b> (pushbutton switch) 28 Calls and indicates the actual function of the HORIZONTAL knob ㉓, [X-POS = dark].
⑥ <b>SETTINGS</b> (pushbutton switch) 23 Opens menu for language and miscellaneous function.	㉓ <b>HORIZONTAL</b> (knob) 29 Controls horizontal position of trace.
⑦ <b>AUTOSET</b> (pushbutton switch) 23 Enables appropriate, signal related, automatic instrument settings.	㉔ <b>TIME/DIV - VAR</b> (knob) 29 Time base A and B deflection coefficient and time base variable control.
⑧ <b>HELP</b> (pushbutton switch) 23 Switches help texts regarding controls and menus ON and OFF.	㉕ <b>MAG x10</b> (pushbutton switch) 29 10 fold expansion in X direction in Yt mode, with simultaneous change of the deflection coefficient display in the readout.
⑨ <b>POSITION 1</b> (knob) 23 Controls position of actual present functions: Signal, Cursor and Trace Separation (time base B).	㉖ <b>HOR / VAR</b> (pushbutton switch) 29 Calls analog time base A and B mode setting, time base variable and hold off control.
⑩ <b>POSITION 2</b> (knob) 23 Controls position of actual present functions: Signal, Cursor and Trace Separation (time base B).	㉗ <b>CH1 / VAR</b> (pushbutton switch) 30 Calls channel 1 menu with input coupling, inverting, probe and Y variable control.
⑪ <b>CH1/2-CURSOR-TRACE SEP</b> (pushbutton switch) 24 Calls the menu and indicates the current function of POSITION 1 and 2 controls.	㉘ <b>VERT/XY</b> (pushbutton switch) 31 Calls vertical mode selection, addition, XY mode and bandwidth limiter.
⑫ <b>VOLTS/DIV-VAR</b> (knob) 24 Channel 1 Y deflection coefficient and variabel setting.	㉙ <b>CH2 / VAR</b> (pushbutton switch) 32 Calls channel 1 menu with input coupling, inverting, probe and Y variable control.
⑬ <b>VOLTS/DIV-VAR</b> (knob) 24 Channel 2 Y deflection coefficient and variabel setting.	⑳ <b>CH1</b> (BNC-socket) 33 Channel 1 signal input and input for horizontal deflection in XY mode.
⑭ <b>AUTO / CURSOR MEASURE</b> (pushbutton switch) 25 Calls menus and submenus for automatic and cursor supported measurement.	㉑ <b>CH2</b> (BNC-socket) 33 Channel 2 signal input.
⑮ <b>LEVEL A/B</b> (knob) 26 Trigger level control for time base A and B.	㉒ <b>AUX</b> (pushbutton switch) 33 Calls AUXILIARY INPUT menu with intensity modulation [Z] and external triggering selectable.
⑯ <b>MODE</b> (pushbutton switch) 26 Calls selectable trigger modes.	㉓ <b>AUXILIARY INPUT</b> (BNC-socket) 33 Input for external trigger or intensity [Z] modulation signal.
⑰ <b>FILTER</b> (pushbutton switch) 27 Calls selectable trigger filter (coupling) and trigger slope menu.	㉔ <b>PROBE / ADJ</b> (socket) 33 Square wave signal output for frequency compensation of x10 probes.



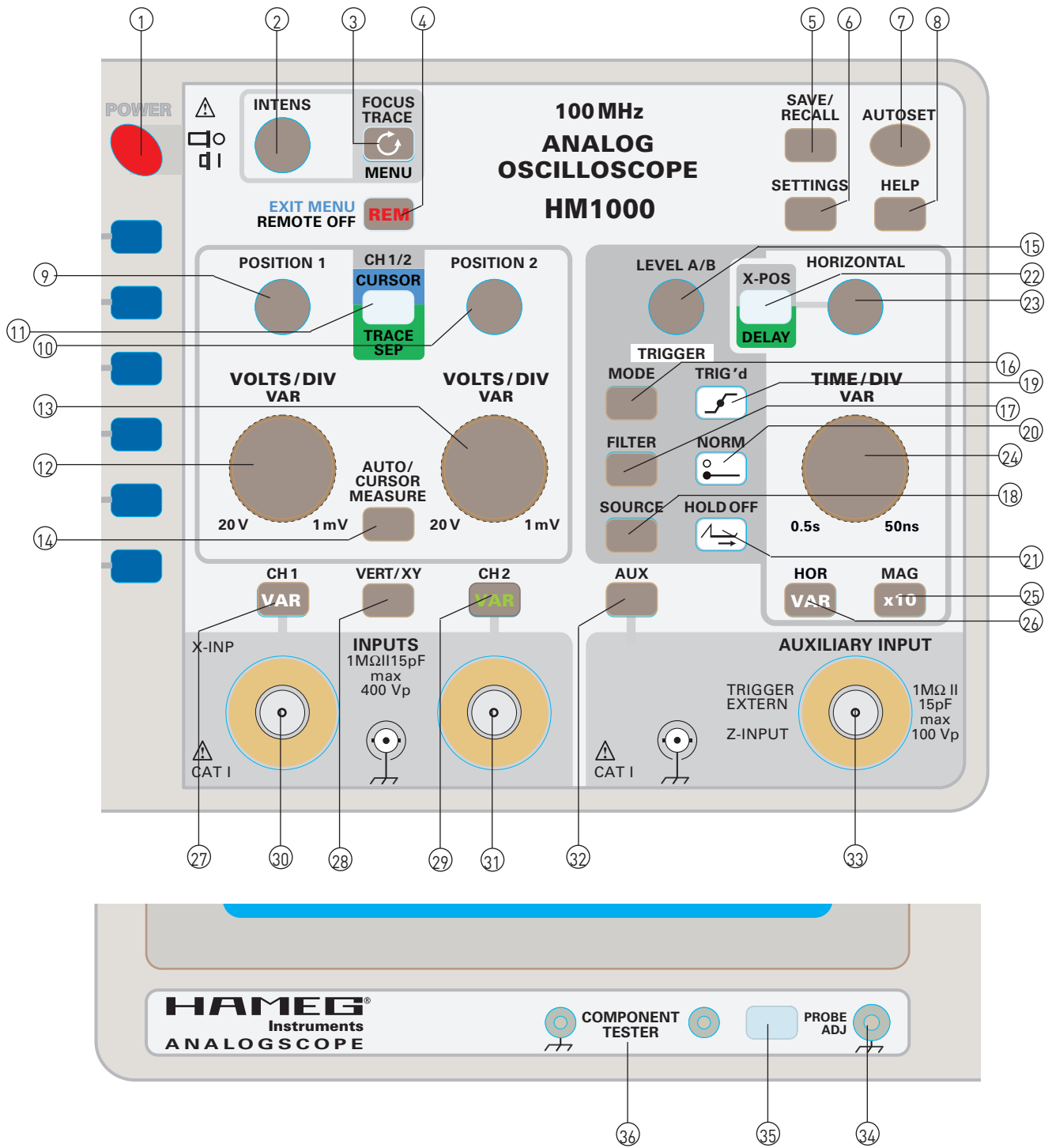

- 35 **PROBE / COMPONENT** (pushbutton switch) 33  
 Calls COMPONENT TESTER mode settings and frequency selection of PROBE ADJ signal.
- 36 **COMPONENT TESTER** (2 sockets with 4 mm Ø) 33  
 Connectors for test leads of the Component Tester. Left socket is galvanically connected with protective earth.

## Basic signal measurement

## Signals which can be measured

The oscilloscope HM1000 can display all repetitive signals with a fundamental repetition frequency of at least 100 MHz. The frequency response is 0 to 100 MHz (-3 dB). The vertical amplifiers will not distort signals by overshoots, undershoots, ringing etc.

Simple electrical signals like sine waves from line frequency ripple to hf will be displayed without problems. However, when measuring sine waves, the amplitudes will be displayed with an error increasing with frequency. At 80 MHz the amplitude error will be around -10 %. As the bandwidths of individual instruments will show a certain spread (the 100 MHz are a guaranteed minimum) the actual measurement error for sine waves cannot be exactly determined.

Pulse signals contain harmonics of their fundamental frequency which must be represented, so the maximum useful repetition frequency of nonsinusoidal signals is much lower than 100 MHz. The criterion is the relationship between the rise times of the signal and the scope; the scope's rise time should be  $<1/3$  of the signal's rise time if a faithful reproduction without too much rounding of the signal shape is to be preserved.

The display of a mixture of signals is especially difficult if it contains no single frequency with a higher amplitude than those of the other ones as the scope's trigger system normally reacts to a certain amplitude. This is e.g. typical of burst signals. Display of such signals may require using the HOLD-OFF control.

Composite video signals may be displayed easily as the instrument has a tv sync separator.

The maximum sweep speed of 5 ns/cm allows sufficient time resolution, e.g. a 100 MHz sine wave will be displayed one period per 2 cm.

The vertical amplifier inputs may be dc or ac coupled. Use dc coupling only if necessary and preferably with a probe.

Low frequency signals when ac coupled will show tilt (ac low frequency -3 dB point is 1.6 Hz), so if possible use dc coupling. Using a probe with 10:1 or higher attenuation will lower the -3 dB point by the probe factor. If a probe cannot be used due to the loss of sensitivity dc coupling the scope and an external large capacitor may help which, of course, must have a sufficient DC rating. Care must be taken, however, when charging and discharging a large capacitor.

Dc coupling is preferable with all signals of varying duty cycle, otherwise the display will move up and down depending on the duty cycle. Of course, pure dc can only be measured with DC coupling. The readout will show which coupling was chosen: = stands for DC, ~ stands for AC.

## Amplitude of signals

In contrast to the general use of rms values in electrical engineering oscilloscopes are calibrated in  $V_{pp}$  as that is what is displayed. Derive rms from  $V_{pp}$ : divide by 2.84. Derive  $V_{pp}$  from rms: multiply by 2.84.

## Values of a sine wave signal

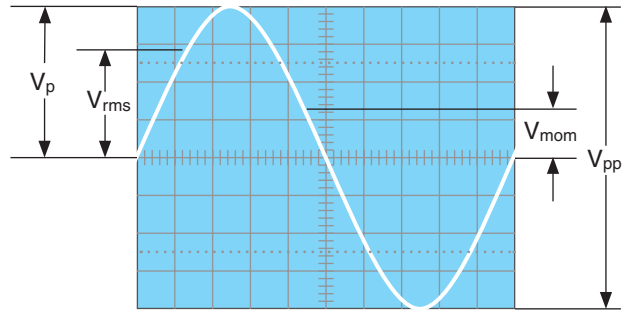

$V_{rms}$  = rms value  
 $V_{pp}$  = pp - value  
 $V_{mom}$  = momentary value, depends on time vs period.

The minimum signal for a one cm display is  $1 \text{ mV}_{pp} \pm 5\%$  provided  $1 \text{ mV/cm}$  was selected and the variable is in the calibrated position.

The available sensitivities are given in  $\text{mV}_{pp}$  or  $V_{pp}$ . The cursors allow to indicate the amplitudes of the signals immediately on the readout as the attenuation of probes is automatically taken into account. Even if the probe attenuation was selected manually this will be overridden if the scope identifies a probe with an identification contact as different. The readout will always give the true amplitude.

It is important that the variable be in its calibrated position. The sensitivity may be continuously decreased by using the variable (see Controls and Readout). Each intermediate value between the calibrated positions 1-2-5 may be selected. Without using a probe thus a maximum of  $400 V_{PP}$  may be displayed ( $20 \text{ V/div} \times 8 \text{ cm screen} \times 2.5 \text{ variable}$ ).

Amplitudes may be directly read off the screen by measuring the height and multiplying by the  $V/\text{div}$ . setting.

**Please note!**  
**Without a probe the maximum permissible voltage at the inputs must not exceed 400 Vp irrespective of polarity.**

In case of signals with a dc content the peak value DC + AC peak must not exceed + or - 400 Vp. Pure ac of up to  $800 V_{PP}$  is permissible.

**If probes are used their possibly higher ratings are only usable if the scope is dc coupled.**

In case of measuring dc with a probe while the scope input is ac coupled the capacitor in the scope input will see the input dc voltage as it is in series with the internal  $1 \text{ M}\Omega$  resistor. This means that the maximum dc voltage (or DC + peak AC) is that of the scope input, i.e.  $400 V_P$ ! With signals which contain DC and AC the DC content will stress the input capacitor while the ac content will be divided depending on the ac impedance of the capacitor. It may be assumed that this is negligible for frequencies  $>40 \text{ Hz}$ .

Considering the foregoing you may measure dc signals of up to  $400 \text{ V}$  or pure AC signals of up to  $800 V_{PP}$  with a HZ200 probe. Probes with higher attenuation like HZ53 100:1 allow to measure DC up to  $1200 \text{ V}$  and pure ac of up to  $2400 V_{PP}$ . (Please note the derating for higher frequencies, consult the HZ53 manual). Stressing a 10:1 probe beyond its ratings will risk destruction of

the capacitor bridging the input resistor with possible ensuing damage of the scope input!

In case the residual ripple of a high voltage is to be measured a high voltage capacitor may be inserted in front of a 10:1 probe, it will take most of the voltage as the value of the probe's internal capacitor is very low, 22 to 68 nF will be sufficient.

If the input selector is switched to Ground the reference trace on the screen may be positioned at graticule center or elsewhere.

### DC and ac components of an input signal

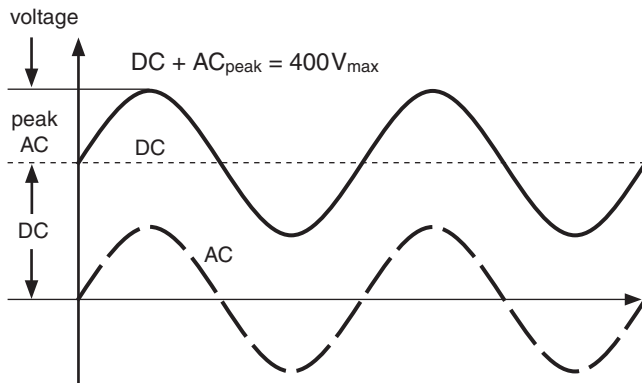

The dashed curve shows an ac signal symmetrical to zero. If there is a dc component the peak value will be DC + AC peak.

### Timing relationships

The repetition frequency of a signal is equal to the number of periods per second. Depending on the TIME/DIV setting one or more periods or part of a period of the signal may be displayed. The time base settings will be indicated on the readout in s/cm, ms/cm, μs/cm and ns/cm. Also the cursors may be used to measure the frequency or the period.

If portions of the signal are to be measured use delayed sweep or the magnifier x 10. Use the HORIZONTAL positioning control to shift the portion to be zoomed into the screen center.

Pulse signals are characterized by their rise and fall times which are measured between the 10 % and 90 % portions. The following example uses the internal graticule of the CRT, but also the cursors may be used for measurement.

#### Measurement:

- Adjust the rising portion of the signal to 5 cm.
- Position the rising portion symmetrically to the graticule centre line, using both Y and X positioning controls.

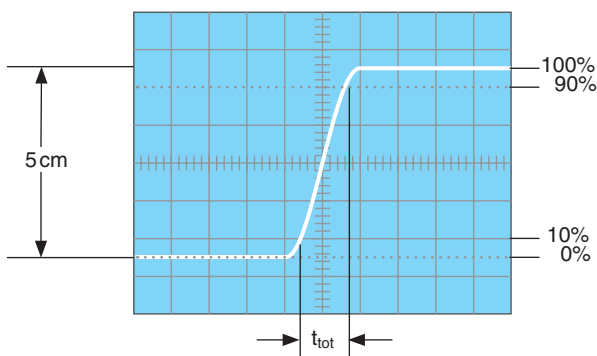

- Notice the intersections of the signal with the 10 and 90 % lines and project these points to the centre line in order to read the time difference.

In the example it was 1.6 cm at 5 ns/cm equals 8 ns rise time.

When measuring very short rise times coming close to the scope rise time it is necessary to subtract the scope's (and if used the probe's) rise times geometrically from the rise time as seen on the screen. The true signal rise time will become:

$$t_a = \sqrt{t_{tot}^2 - t_{osc}^2 - t_t^2}$$

$t_{tot}$  is the rise time seen,  $t_{osc}$  is the scope's own rise time (3.5 ns with the HM1000),  $t_t$  is the rise time of the probe, e.g. 2 ns. If the signal's rise time is > 34 ns, the rise times of scope and probe may be neglected.

$$t_a = \sqrt{8^2 - 3.5^2 - 2^2} = 6,9 \text{ ns}$$

For the measurement of rise times it is not necessary to proceed as outlined above. Rise times may be measured anywhere on the screen. It is mandatory that the rising portion of the signal be measured in full and that the 10 to 90 % are observed. In case of signals with over- or undershoot the 0 and 100 % levels are those of the horizontal portions of the signal, i.e. the over- resp. undershoots must be disregarded for rise and fall time measurements. Also, glitches will be disregarded. If signals are very distorted, however, rise and fall time measurements may be of no value.

For most amplifiers, even if their pulse behaviour is far from ideal, the following relationship holds:

$$t_a = \frac{350}{B} \quad B = \frac{350}{t_a}$$

$$tr/ns = 350/Bandwidth/MHz$$

### Connection of signals

In most cases pressing the AUTOSET button will yield a satisfactory display [see AUTOSET]. The following relates to special cases where manual settings will be advisable. For a description of controls refer to "Controls and Readout".

 **Take care when connecting unknown signals to the inputs!**

It is recommended to use probes whenever possible. Without a probe start with the attenuator set to its 20 V/cm position. If the trace disappears the signal amplitude may be too large overdriving the vertical amplifier or/and its dc content may be too high. Reduce the sensitivity until the trace will reappear onscreen. If calibrated measurements are desired it will be necessary to use a probe if the signal becomes >160 V<sub>p</sub>. Check the probe specifications in order to avoid overstressing. If the time base is set too fast the trace may become invisible, then reduce the time base speed.

If no probe is used at least screened cable should be used, such as HZ32 or HZ34. However, this is only advisable for low impedance sources or low frequencies (<50 kHz). With high frequencies impedance matching will be necessary.

Nonsinusoidal signals require impedance matching, at both ends preferably. At the scope input a feed through - 50Ω-termination will be required. HAMEG offers a HZ22 termination. If proper terminations are not used sizeable pulse aberrations will result. Also sine wave signals of > 100 kHz should be properly terminated. Most generators control signal amplitudes only if correctly terminated.

HZ22 may only be used up to  $7 V_{rms}$  or  $20 V_{pp}$  i.e. 1 W. For probes terminations are neither required nor allowed, they would ruin the signal.

Probes feature very low loads at fairly low frequencies: 10 M $\Omega$  in parallel to a few pF, valid up to several hundred kHz. However, the input impedance diminishes with rising frequency to quite low values. This has to be borne in mind as probes are, e.g., entirely unsuitable to measure signals across high impedance high frequency circuits such as bandfilters etc.! Here only FET probes can be used. Use of a probe as a rule will also protect the scope input due to the high probe series resistance (9 M $\Omega$ ). As probes cannot be calibrated exactly enough during manufacturing individual calibration with the scope input used is mandatory! (See Probe Calibration).

Passive probes will, as a rule, decrease the scope bandwidth resp. increase the rise time. We recommend to use HZ200 probes in order to make maximum use of the combined bandwidth. HZ200 features 2 additional hf compensation adjustments.

Whenever the DC content is  $> 400 V_{DC}$  coupling must be used in order to prevent overstressing the scope input capacitor. This is especially important if a 100:1 probe is used as this is specified for 1200  $V_{DC}$  + peak AC.

AC coupling of low frequency signals may produce tilt.

If the dc content of a signal must be blocked it is possible to insert a capacitor of proper size and voltage rating in front of the probe, a typical application would be a ripple measurement.

When measuring small voltages the selection of the ground connection is of vital importance. It should be as close to voltage take-off point as possible, otherwise ground currents may deteriorate the measurement. The ground connections of probes are especially critical, they should be as short as possible and of large size.

 **If a probe is to be connected to a BNC connector use a probe tip to BNC adapter.**

If ripple or other interference is visible, especially at high sensitivity, one possible reason may be multiple grounding. The scope itself and most other equipment are connected to safety ground, so ground loops may exist. Also, most instruments will have capacitors between line and safety ground installed which conduct current from the live wire into the safety ground.

## First time operation and initial adjustments

Prior to first time operation the connection between the instrument and safety ground must be ensured, hence the plug must be inserted first.

Use the red pushbutton POWER to turn the scope on. Several displays will light up. The scope will then assume the set-up, which was selected before it was turned off. If no trace and no readout are visible after approximately 20 sec, push the AUTOSET button.

As soon as the trace becomes visible select an average intensity with INTENS, then select FOCUS and adjust it, then select TRACE ROTATION and adjust for a horizontal trace.

With respect to crt life use only as much intensity as necessary and convenient under given ambient light conditions, if unused turn the intensity fully off rather than turning the scope off and on too much, this is detrimental to the life of the crt heater. Do not allow a stationary point to stay, it might burn the crt phosphor.

With unknown signals start with the lowest sensitivity 20 V/cm, connect the input cables to the scope and then to the measuring object which should be deenergized in the beginning. Then turn the measuring object on. If the trace disappears, push AUTOSET.

### Trace rotation TR

The crt has an internal graticule. In order to adjust the deflected beam with respect to this graticule the Trace Rotation control is provided. Select the function Trace Rotation and adjust for a trace which is exactly parallel to the graticule.

### Probe adjustment and use

In order to ensure proper matching of the probe used to the scope input impedance the scope contains a calibrator with short rise time and an amplitude of  $0.2 V_{pp} \pm 1\%$ , equivalent to 4 cm at 5 mV/cm when using 10:1 probes.

The inner diameter of the calibrator connector is 4.9 mm and standardized for series F probes. Using this special connector is the only way to connect a probe to a fast signal source minimizing signal and ground lead lengths and to ensure true displays of pulse signals.

### 1 kHz – adjustment

This basic adjustment will ensure that the capacitive attenuation equals the resistive attenuation thus rendering the attenuation of the probe independent of frequency. 1:1 probes can not be adjusted and need no such adjustment anyway.

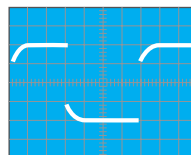

incorrect

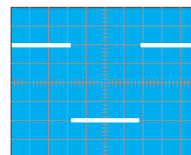

correct

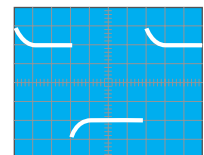

incorrect

Prior to adjustment make sure that the trace rotation adjustment was performed.

Connect the 10:1 probe to the input. Use dc coupling. Set the VOLTS/DIV to 5 mV/cm and TIME/DIV to 0.2 ms/cm, both calibrated. Insert the probe tip into the calibrator connector PROBE ADJ.

You should see 2 signal periods. Adjust the compensation capacitor (see the probe manual for the location) until the square wave tops are exactly parallel to the graticule lines (see picture 1 kHz). The signal height should be 4 cm ±1.6 mm (3% oscilloscope and 1% probe tolerance). The rising and falling portions of the square wave will be invisible.

### 1 MHz adjustment

The HAMEG probes feature additional adjustments in the compensation box which allow to optimise their hf behaviour. This adjustment is a precondition for achieving the maximum bandwidth with probe and a minimum of pulse aberrations.

This adjustment requires a calibrator with a short rise time (typ. 4 ns) and a 50Ω output, a frequency of 1 MHz, an amplitude of 0.2 V<sub>pp</sub>. The PROBE ADJ. output of the scope fulfils these requirements.

Connect the probe to the scope input to which it is to be adjusted. Select the PROBE ADJ. signal 1 MHz. Select dc coupling and 5 mV/cm with VOLTS/DIV. and 0.1 us/cm with TIME/DIV., both calibrated. Insert the probe tip into the calibrator output connector. The screen should show the signal, rise and fall times will be visible. Watch the rising portion and the top left pulse corner, consult the manual for the location of the adjustments.

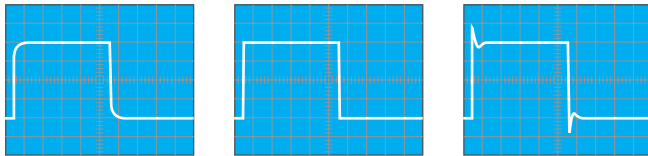

incorrect

correct

incorrect

The criteria for a correct adjustment are:

- short rise time, steep slope.
- clean top left corner with minimum over- or undershoot, flat top.

After adjustment check the amplitude which should be the same as with 1 kHz.

It is important to first adjust 1 kHz, then 1 MHz. It may be necessary to check the 1 kHz adjustment again.

Please note that the calibrator signals are not calibrated with respect to frequency and thus must not be used to check the time base accuracy, also their duty cycle may differ from 1:1. The probe adjustment is completed if the pulse tops are horizontal and the amplitude calibration is correct.

## Operating modes of the vertical amplifier

The controls most important for the vertical amplifier are: VERT/XY ⑳, CH1 ㉗, CH2 ㉘. They give access to the menus containing the operating modes and the parameters of the individual channels.

Changing the operating mode is described in the chapter: "Controls and Readout".

### Remark:

Any reference to "both channels" always refers to channels 1 and 2.

Usually oscilloscopes are used in the Yt mode. The amplitude of the measuring signal will deflect the trace vertically while a time base will deflect it from left to right.

The vertical amplifiers offer these modes:

- One signal only with CH1.
- One signal only with CH2.
- Two signals with channels 1 and 2 (DUAL trace mode)

In DUAL mode both channels are operative. The method of signal display is governed by the time base (see also "Controls and Readout"). Channel switching may either take place after each sweep (alternate) or during sweeps with a high frequency (chopped).

The normal choice is alternate, however, at slow time base settings the channel switching will become visible and disturbing, when this occurs select the chopped mode in order to achieve a stable quiet display.

In ADD mode the two channels 1 and 2 are algebraically added ( $\pm CH1 \pm CH2$ ). With + polarity the channel is normal, with - polarity inverted. If + Ch1 and - CH2 are selected the difference will be displayed or vice versa.

### Same polarity input signals:

- Both channels not inverted: = sum
- Both channels inverted: = sum
- Only one channel inverted: = difference

### Opposite polarity input signals:

- Both channels not inverted: = difference
- Both channels inverted: = difference
- One channel inverted: = sum.



Please note that in ADD mode both position controls will be operative. The INVERT function will not affect positioning.

Often the difference of two signals is to be measured at signal take-offs which are both at a high common mode potential. While this one typical application of the difference mode one important precaution has to be borne in mind: The oscilloscope vertical amplifiers are two separate amplifiers and do not constitute a true difference amplifier with as well a high CM rejection as a high permissible CM range! Therefore please observe the following rule: Always look at the two signals in the one channel only or the dual modes and make sure that they are within the permissible input signal range; this is the case if they can be displayed in these modes. Only then switch to ADD. If this precaution is disregarded grossly false displays

may result as the input range of one or both amplifiers may be exceeded.

Another precondition for obtaining true displays is the use of two identical probes at both inputs. But note that normal probe tolerances (percent) will cause the CM rejection to be expected to be rather moderate. In order to obtain the best possible results proceed as follows: First adjust both probes as carefully as possible, then select the same sensitivity at both inputs and then connect both probes to the output of a pulse generator with sufficient amplitude to yield a good display. Readjust one (!) of the probe adjustment capacitors for a minimum of over- or undershoot. As there is no adjustment provided with which the resistors can be matched a residual pulse signal will be unavoidable.

When making difference measurements it is good practice to first connect the ground cables of the probes to the object prior to connecting the probe tips. There may be high potentials between the object and the scope. If a probe tip is connected first there is danger of overstressing the probe or/and the scope inputs! Never perform difference measurements without both probe ground cables connected.

### XY operation

This mode is accessed by VERT/XY  $\text{\textcircled{>}}$  XY. In XY mode the time will be turned off. The channel 1 signal will deflect in X direction (X-INP. = horizontal input), hence the input attenuators, the variable and the POSITION 1 control will be operative. The HORIZONTAL control will also remain functional.

Channel 2 will deflect in Y direction.

The x 10 magnifier will be inoperative in XY mode. Please note the differences in the Y and X bandwidths, the X amplifier has a lower -3dB frequency than the Y amplifier. Consequently the phase difference between X and Y will increase with frequency.

In XY mode the X signal (CH1 = X-INP). can not be inverted.

**The XY mode may generate Lissajous figures which simplify some measuring tasks and make others possible:**

- Comparison of two signals of different frequency or adjustment of one frequency until it is equal to the other resp. becomes synchronized.
- This is also possible for multiples or fractions of one of the frequencies.

### Phase measurements with Lissajous figures

The following pictures show two sine waves of equal amplitude and frequency but differing phase.

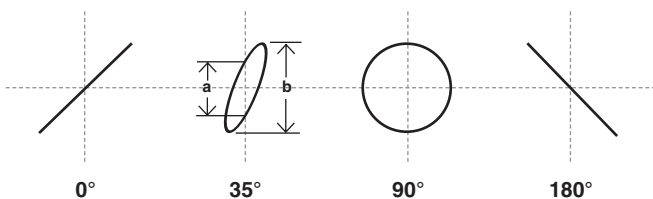

Calculation of the phase angle between the X- and Y-signals (after reading a and b off the screen) is possible using the following formulas and a pocket calculator with trigonometric functions. This calculation is independent of the signal amplitudes:

$$\sin \varphi = \frac{a}{b}$$

$$\cos \varphi = \sqrt{1 - \left(\frac{a}{b}\right)^2}$$

$$\varphi = \arcsin \frac{a}{b}$$

**Please note:**

- As the trigonometric functions are periodic limit the calculation to angles <90 degrees. This is where this function is most useful.
- Do not use too high frequencies, because, as explained above, the two amplifiers are not identical, their phase difference increases with frequency. The spec gives the frequency at which the phase difference will stay <3 degrees.
- The display will not show which of the two frequencies does lead or lag. Use a CR combination in front of the input of the frequency tested. As the input has a 1 MΩ resistor it will be sufficient to insert a suitable capacitor in series. If the ellipse increases with the C compared to the C short-circuited the test signal will lead and vice versa. This is only valid <90 degrees. Hence C should be large and just create a barely visible change.

In XY mode one or both signals disappear, only a line or a point will appear, mostly very bright. In case of only a point there is danger of phosphor burn, so turn the intensity down immediately; if only a line is shown the danger of burn will increase the shorter the line is. Phosphor burn is permanent.

### Measurement of phase differences in dual channel Yt mode

**Please note:** Do not use "alternate trigger" because the time differences shown are arbitrary and depend only on the respective signal shapes! Make it a rule to use alternate trigger only in rare special cases.

The best method of measuring time or phase differences is using the dual channel Yt mode. Of course, only times may be read off the screen, the phase must then be calculated as the frequency is known. This is a much more accurate and convenient method as the full bandwidth of the scope is used, and both amplifiers are almost identical. Trigger the time base from the signal which shall be the reference. It is necessary to position both traces without signal exactly on the graticule center (POSITION 1 and 2). The variables and trigger level controls may be used, this will not influence the time difference measurement. For best accuracy display only one period at high amplitude und observe the zero crossings. One period equals 360 degrees. It may be advantageous to use ac coupling if there is an offset in the signals.

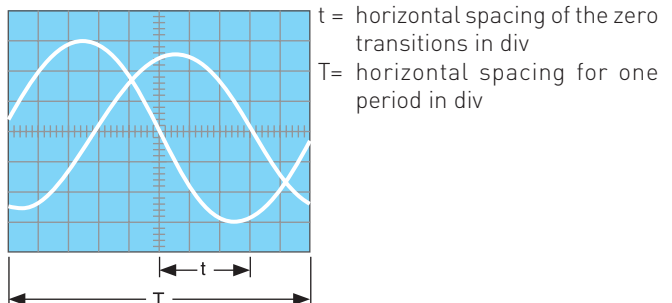

In this example  $t = 3 \text{ cm}$  and  $T = 10 \text{ cm}$ , the phase difference in degrees will result from:

$$\varphi^\circ = \frac{5}{T} \cdot 360^\circ = \frac{3}{10} \cdot 360^\circ = 108^\circ$$

or in angular units:

$$\text{arc } \varphi^\circ = \frac{t}{T} \cdot 2\pi = \frac{3}{10} \cdot 2\pi = 1,885 \text{ rad}$$

Very small phase differences with moderately high frequencies may yield better results with Lissajous figures.

However, in order to get higher precision it is possible to switch to higher sensitivities – after accurately positioning at graticule centre – thus overdriving the inputs resulting in sharper zero crossings. Also, it is possible to use half a period over the full 10 cm. As the time base is quite accurate increasing the time base speed after adjusting for e.g. one period = 10 cm and positioning the first crossing on the first graticule line will also give better resolution.

### Measurement of amplitude modulation

Please note: Use this only in analog mode because in DSO mode alias displays may void the measurement! For the display of low modulation frequencies a slow time base (TIME/DIV) has to be selected in order to display one full period of the modulating signal. As the sampling frequency of any DSO must be reduced at slow time bases it may become too low for a true representation.

The momentary amplitude at time t of a hf carrier frequency modulated by a sinusoidal low frequency is given by:

$$u = U_T \cdot \sin \Omega t + 0,5m \cdot U_T \cdot \cos(\Omega - \omega) t - 0,5m \cdot U_T \cdot \cos(\Omega + \omega) t$$

where:  $U_T$  = amplitude of the unmodulated carrier  
 $\Omega = 2\pi F =$  angular carrier frequency  
 $\omega = 2\pi f =$  modulation angular frequency  
 $m =$  modulation degree ( $\leq 1 \hat{=} 100\%$ )

In addition to the carrier a lower side band  $F - f$  and an upper side band  $F + f$  will be generated by the modulation.

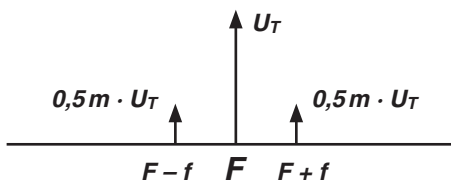

Picture 1: Amplitudes and frequencies with AM (m = 50 %) of the spectra

As long as the frequencies involved remain within the scope's bandwidth the amplitude-modulated hf can be displayed. Preferably the time base is adjusted so that several signal periods will be displayed. Triggering is best done from the modulation frequency. Sometimes a stable displayed can be achieved by twiddling with the time base variable.

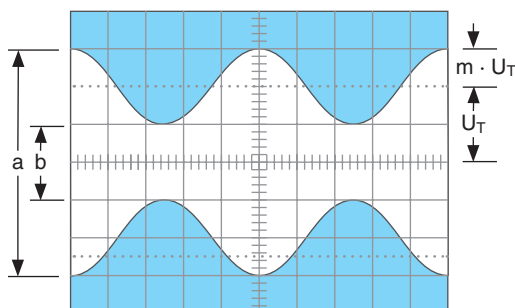

Picture 2: Amplitude modulated hf.  $F = 1 \text{ MHz}$ ,  $f = 1 \text{ kHz}$ ,  $m = 50 \%$ ,  $U_T = 28,3 \text{ mV}_{\text{rms}}$   
 Set the scope controls as follows in order to display the picture 2 signal:

CH1 only, 20 mV/cm, AC  
 TIME/DIV: 0.2 ms/cm  
 Triggering: NORMAL, AC, internal.  
 Use the time base variable or external triggering.

Reading a and b off the screen the modulation degree will result:

$$m = \frac{a-b}{a+b} \quad \text{or} \quad m = \frac{a-b}{a+b} \cdot 100 [\%]$$

$$a = U_T(1 + m) \quad \text{and} \quad b = U_T(1 - m)$$

When measuring the modulation degree the amplitude and time variables can be used without any influence on the result.

## Triggering and time base

The most important controls and displays for these functions are to be found in the shaded TRIGGER area, they are described in „Controls and Readout“.-

In YT mode the signal will deflect the trace vertically while the time will deflect it horizontally, the speed can be selected. In general periodic voltage signals are displayed with a periodically repeating time base. In order to have a stable display successive periods must trigger the time base at exactly the same time position of the signal (amplitude and slope).

 **Pure DC can not trigger the time base, a voltage change is necessary.**

Triggering may be internal from any of the input signals or externally from a time-related signal.

For triggering a minimum signal amplitude is required which can be determined with a sine wave signal. With internal triggering the trigger take-off within the vertical amplifiers is directly following the attenuators. The minimum amplitude is specified in mm on the screen. Thus it is not necessary to give a minimum voltage for each setting of the attenuator.

For external triggering the appropriate input connector is used, the amplitude necessary there is given in  $V_{pp}$ . The voltage for triggering may be much higher than the minimum, however, it should be limited to 20 times the minimum. Please note that for good triggering the voltage resp. signal height should be a good deal above the minimum. The scope features two trigger modes to be described in the following:

### Automatic peak triggering (MODE menu)

Consult the chapters MODE 16 > AUTO, LEVEL A/B 15, FILTER 17 and SOURCE 18 in "Controls and Readout". Using AUTOSET this trigger mode will be automatically selected. With dc coupling and with alternate trigger this mode will be left while the automatic triggering will remain.

Automatic triggering causes a new time base start after the end of the foregoing and after the hold-off time has elapsed even without any input signal. Thus there is always a visible trace. The position of the trace(s) without any signal is then given by the settings of the POSITION controls.

As long as there is a signal scope operation will not need more than a correct amplitude and time base setting. With signals < 20 Hz their period is longer than the time the auto trigger circuit will wait for a new trigger, consequently the auto trigger circuit will start the time base then irrespective of the signal so that the display will not be triggered and free run, quite independent of the signal's amplitude which may be much larger than the minimum.

Also in auto peak trigger mode the trigger level control is active. Its range will be automatically adjusted to coincide with the signal's peak-to-peak amplitude, hence the name. The trigger point will thus become almost independent of signal amplitude. This means that even if the signal is decreased the trigger will follow, the display will not lose trigger. As an example: the duty cycle of a square wave may change between 1:1 and 100:1 without losing the trigger.

Depending on the signal the LEVEL A/B control may have to be set to one of its extreme positions.

The simplicity of this mode recommends it for most uncomplicated signals. It is also preferable for unknown signals.

This trigger mode is independent of the trigger source and usable as well for internal as external triggering. But the signal must be > 20 Hz.

### Normal trigger mode (See menu MODE)

Consult the chapters: MODE ⑯ > AUTO, LEVEL A/B ⑮, FILTER ⑰ and SOURCE ⑱ in "Controls and Readout". Information about how to trigger very difficult signals can be found in the HOR menu ⑳ where the functions time base fine adjustment VAR, HOLD-OFF time setting, and time base B operation are explained.

With normal triggering and suitable trigger level setting triggering may be chosen on any point of the signal slope. Here, the range of the trigger level control depends on the trigger signal amplitude. With signals < 1 cm care is necessary.

In normal mode triggering there will be no trace visible in the absence of a signal or when the signal is below the minimum trigger amplitude requirement!

Normal triggering will function even with complicated signals. If a mixture of signals is displayed triggering will require repetition of amplitudes to which the level can be set. This may require special care in adjustment.

### Slope selection (Menu FILTER)

After entering FILTER ⑰ the trigger slope may be selected using the function keys. See also "Controls and Readout". AUTOSET will not change the slope.

Positive or negative slope may be selected in auto or normal trigger modes. Also, a setting "both" may be selected which will cause a trigger irrespective of the polarity of the next slope.

Rising slope means that a signal comes from a negative potential and rises towards a positive one. This is independent

of the vertical position. A positive slope may exist also in the negative portion of a signal. This is valid in automatic and normal modes.

### Trigger coupling (Menu: FILTER)

Consult chapters: MODE ⑯ > AUTO, LEVEL A/B ⑮, FILTER ⑰ and SOURCE ⑱ in "Controls and Readout". In AUTOSET DC-coupling will be used unless ac coupling was selected before. The frequency responses in the diverse trigger modes may be found in the specifications.

With internal dc coupling with or without LF filter use normal triggering and the level control. The trigger coupling selected will determine the frequency response of the trigger channel.

#### AC:

This is the standard mode. Below and above the fall-off of the frequency response more trigger signal will be necessary.

#### DC:

With direct coupling there is no lower frequency limit, so this is used with very slowly varying signals. Use normal triggering and the level control. This coupling is also indicated if the signal varies in its duty cycle.

#### HF:

A high pass is inserted in the trigger channel, thus blocking low frequency interference like flicker noise etc.

#### Noise Reject:

This trigger coupling mode or filter is a low pass suppressing high frequencies. This is useful in order to eliminate hf interference of low frequency signals. This filter may be used in combination with dc or ac coupling, in the latter case very low frequencies will also be attenuated.

#### LF:

This is also a low pass filter with a still lower cut-off frequency than above which also can be combined with dc or ac coupling. Selecting this filter may be more advantageous than using DC-coupling in order to suppress noise producing jitter or double images. Above the pass band the necessary trigger signal will rise. Together with ac coupling there will also result a low frequency cut-off.

### Video (tv triggering)

Selecting MODE > Video will activate the TV sync separator built-in. It separates the sync pulses from the picture content and enables thus stable triggering independent of the changing video content.

Composite video signals may be positive or negative. The sync pulses will only be properly extracted if the polarity is right. The definition of polarity is as follows: if the video is above the sync it is positive, otherwise it is negative. The polarity can be selected after selecting FILTER. If the polarity is wrong the display will be unstable resp. not triggered at all as triggering will then be initiated by the video content. With internal triggering a minimum signal height of 5 mm is necessary.

The PAL sync signal consists of line and frame signals which differ in duration. Pulse duration is 5  $\mu$ s in 64  $\mu$ s intervals. Frame sync pulses consist of several pulses each 28  $\mu$ s repeating each half frame in 20 ms intervals.

Both sync pulses differ hence as well in duration as in their repetition intervals. Triggering is possible with both.



## Frame sync pulse triggering

### Remark:

**Using frame sync triggering in dual trace chopped mode may result in interference, then the dual trace alternate mode should be chosen. It may also be necessary to turn the read-out off.**

In order to achieve frame sync pulse triggering call MODE, select video signal triggering and then FILTER to select frame triggering. It may be selected further whether "all", "only even" or "only odd" half frames shall trigger. Of course, the correct TV standard must be selected first of all (625/50 or 525/60).

The time base setting should be adapted, with 2 ms/cm a complete half frame will be displayed. Frame sync pulses consist of several pulses with a half line rep rate.

## Line sync pulse triggering

In order to choose line sync triggering call MODE and select VIDEO, enter FILTER, make sure that the correct video standard is selected (625/50 or 525/60) and select Line.

If "ALL" was selected each line sync pulse will trigger. It is also possible to select a line number "LINE No."

In order to display single lines a time base setting of TIME/DIV. = 10  $\mu$ s/cm is recommended, this will show 1½ lines. In general the composite video signal contains a high dc component which can be removed by ac coupling, provided the picture is steady. Use the POSITION control to keep the display within the screen. If the video content changes like with a regular tv program only DC coupling is useful, otherwise the vertical position would continuously move.

The sync separator is also operative with external triggering. Consult the specifications for the permissible range of trigger voltage. The correct slope must be chosen as the external trigger may have a different polarity from the composite video. In case of doubt display the external trigger signal.

## LINE trigger

Consult SOURCE ⑩ in "Controls and Readout" for specific information.

If the readout shows Tr:Line the trigger signal will be internally taken from the line (50 or 60 Hz).

This trigger signal is independent of the scope input signals and is recommended for all signals synchronous with the line. Within limits this will also be true for multiples or fractions of the line frequency. As the trigger signal is taken off internally there is no minimum signal height on the screen for a stable display. Hence even very small voltages like ripple or line frequency interference can be measured.

Please note that with line triggering the polarity switching will select either the positive or negative half period of the line, not the slope. The trigger level control will move the trigger point over most of a half wave.

Line frequency interference may be checked using a search coil which preferably should have a high number of turns and a shielded cable. Insert a 100  $\Omega$  resistor between the center conductor and the BNC connector. If possible the coil should be shielded without creating a shorted winding.

## Alternate trigger

This mode is selected with SOURCE ⑩ > Alt. 1/2. The readout will display Tr:alt, but no more the trigger point symbol indicating level and time position. Instead an arrow pointing upwards will indicate the trigger time position if this lies within the screen area.

This trigger mode is to be used with greatest care and should be an exception rather than the rule, because the time relationships visible on the screen are completely meaningless, they depend only on the shape of the signals and the trigger level!

In this mode the trigger source will be switched together with the channel switching, so that when CH1 is displayed in the dual channel alternate mode the trigger is taken from CH1 and when CH2 is displayed the trigger is taken from CH2. This way two uncorrelated signals can be displayed together. If this mode is inadvertently chosen the time relationships between the signals will also be lost when both signals are correlated! (Except for the special case that both happen to be square waves with extremely fast rise times). Of course, this trigger mode is only possible in the dual channel alternate mode and also not with external or line trigger. Ac coupling is recommended for most cases.

## External triggering

This trigger mode may be selected with SOURCE ⑩ > Extern. The readout will display Tr:ext. AUXILIARY INPUT ③ will be the input for the external trigger signal, all internal triggersources will be disconnected. In this mode the trigger point symbol (level and time position) will not be displayed, only the trigger time position will be indicated. External triggering requires a signal of 0.3 to 3 V<sub>PP</sub>, synchronous to the vertical input signal(s).

Triggering will also be possible within limits with multiples or fractions of the vertical input signal frequency. As the trigger signal may have any polarity it may happen that the vertical input signal will start with a negative slope in spite of having selected positive slope; slope selection refers now to the external trigger.

## Indication of triggered operation (TRIG'D LED)

Refer item ⑨ in "Controls and Readout". The LED labelled TRIG'D indicates triggered operation provided:

- Sufficient amplitude of the internal or external trigger signal.
- The trigger point symbol is not above or below the signal.

If these conditions are met the trigger comparator will output triggers to start the time base and to turn on the trigger indication. The trigger indicator is helpful for setting the trigger up, especially with low frequency signals (use normal trigger) resp. very short pulses.

The trigger indication will store and display triggers for 100 ms. With signals of very low rep rate the indicator will flash accordingly. If more than one signal period is shown on the screen the indicator will flash each period.

## Hold-off time adjustment

Consult "Controls and Readout" HOR ⑥ > Hold-off time for specific information.

After the time base deflected the trace from left to right the trace will be blanked so the retrace is invisible. The next sweep will, however, not immediately start. Time is required to perform internal switching, so the next start is delayed for the so called hold-off time, irrespective of the presence of triggers. The hold-off time can be extended from its minimum by a factor of 10:1. Manipulation of the hold-off time and thus of the time for a complete sweep period from start to start can be useful e.g. when data packets are to be displayed. It may seem that such signals can not be triggered. The reason is that the possible start of a new sweep does not coincide with the start of a data packet, it may start anywhere, even before a data packet. By varying the hold-off time a stable display will be achieved by setting it just so that the hold-off ends before the start of a data packet. This is also handy with burst signals or non-periodic pulse trains.

A signal may be corrupted by noise or hf interference so a double display will appear. Sometimes varying the trigger level can not prevent the double display but will only affect the apparent time relationship between two signals. Here the variable hold-off time will help to arrive at a single display.

Sometimes a double display will appear when a pulse signal contains pulses of slightly differing height requiring delicate trigger level adjustment. Also here increasing the hold-off time will help.

Whenever the hold-off time was increased it should reset to its minimum for other measurements, otherwise the brightness will suffer as the sweep rep rate will not be maximum. The following pictures demonstrate the function of the hold-off:

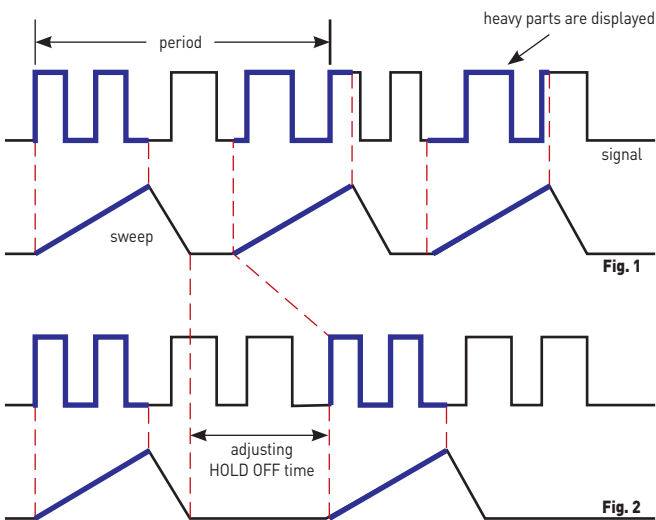

**Picture 1: Display with minimum hold-off time (basic setting). Double image, no stable display.**

**Picture 2: By increasing the hold-off a stable display is achieved.**

### Time base B (2<sup>nd</sup> time base), Delaying, Delayed, Sweep

Consult "Controls and Readout" HOR ⑳ and TIME/DIV. ㉑ for specific information.

As was described in "Triggering and time base" a trigger will start the time base. While waiting for a trigger – after runout of the hold-off time – the trace will remain blanked. A trigger will cause trace unblanking and the sweep ramp which deflects

the trace from left to right with the speed set with TIME/DIV. At the end of the sweep the trace will be blanked again and retrace to the start position. During a sweep the trace will also be deflected vertically by the input signal. In fact the input signal does continuously deflect the trace vertically, but this will be only visible during the unblanking time.

Let us assume one period of a signal is displayed at a convenient time base setting. Increasing the sweep speed with TIME/DIV. will expand the display from the start, so that parts of the signal will disappear from the screen. It is thus possible to expand the beginning of the signal period and show fine detail, but it is impossible to show such fine detail for "later" parts of the signal.

The x10 Magnifier (MAG x10) may be used to expand the display and the horizontal positioning control can shift any part of the display into the centre, but the factor of 10 is fixed.

The solution requires a second time base, called time base B.

In this mode time base A is called the delaying sweep and time base B the delayed sweep. The signal is first displayed by TB A alone. Then TB B is also turned on which is the mode "A intensified by B". TB B should always be set to a higher sweep rate than A, thus its sweep duration will be also shorter than that of A. The TB A sweep sawtooth is compared to a voltage which can be varied such that TB A functions as a precision time delay generator. Depending on the amplitude of the comparison voltage a signal is generated anywhere between sweep start and end.

In one of two operating modes this signal will start TB B immediately. The TB A display will be intensified for the duration of TB B, so that one sees which portion of the signal is covered by TB B. By varying the comparison voltage the start of TB B can be moved over the whole signal as it is displayed by TB A. Then the mode is switched to TB B. The signal portion thus selected is now displayed by TB B. This is called "B delayed by A". Portions of the signal can thus be expanded enormously, however, the higher the speed of TB B the darker the display will become as the rep rate will remain that of the accepted signal triggers while the duration of TB B is reduced with increasing speed.

In cases where there is jitter the TB B can be switched to wait for a trigger rather than starting immediately. When a trigger arrives TB B will start on it. The jitter is removed, however, the effect is also, that the TB B start now can be only from signal period, no continuous adjustment is possible in this mode.

### Alternate sweep

In this mode the signal is displayed twice, with both time bases. An artificial Y offset can be added in order to separate the two displays on the screen. The operation is analogous to Y dual trace alternate mode, i.e., the signal is alternately displayed by both time bases, not simultaneously which is not possible with a single gun crt. What was said above about how TB B can be started holds also here.

## AUTOSET

For specific information consult "Controls and Readout" AUTOSET ⑦.

The following description is valid for both analog and DSO modes. AUTOSET does not change from analog to DSO mode or vice versa. If in DSO mode the modes "Roll", "Envelope" or "Average" (ACQUIRE) are present or the trigger mode „Single" (MODE) is selected, these modes will be switched off as AUTOSET always switches to "Refresh" acquisition. The signal to be displayed must meet the amplitude and frequency requirements of automatic triggering, to enable a useful automatic instrument setting.

All controls except for the POWER switch are electronically scanned, all functions can also be controlled by the microcomputer, i.e. also via the interfaces.

This is a precondition for AUTOSET as this function must be able to control all functions independent of control settings. AUTOSET will always switch to YT mode, but preserve the previous selection of CH1, CH2 or dual trace; ADD or XY modes will be switched to dual trace Yt.

Automatic setting of the vertical sensitivities and the time base will present a display within 6 cm height (4 cm per signal in dual trace) and about 2 signal periods. This is true for signals not differing too much from a 1:1 duty cycle. For signals containing several frequencies like video signals the display may be any.

Initiating the AUTOSET function will set the following operating conditions:

- last selection of ac or dc coupling
- internal triggering
- automatic triggering
- trigger level set to the center of its range
- calibrated Y sensitivities
- calibrated time base
- AC or DC trigger coupling unmodified
- HF trigger coupling switched to DC
- LF or Noise Reject filters left
- X magnifier switched off
- Y and X positioning automatic

### Please note:

**For pulse signals with duty cycles approaching 400:1 no automatic signal display will be possible.**

In such cases switch to normal trigger mode and set the trigger position about 5 mm above the centre. If the trigger LED will then light up a trigger is generated and the time base is operating. In order to obtain a visible display it may be necessary to change the time base and V/DIV settings. Depending on the duty cycle and the frequency the signal may still remain invisible.

## Component tester

Specific information can be found in "Controls and Readout" under COMPONENT/PROBE ⑤ and COMPONENT TESTER ⑥.

The scope has a built-in component tester. The test object is connected with 4 mm banana plugs. In this mode the Y amplifiers and the time base are turned off. Only individual components may be tested, i.e. they must not be part of a circuit, if voltages are to be applied to the BNC connectors. If the components are part of a circuit this must be deenergized and disconnected from safety ground. Except for the two test leads there may be no further connection between scope and component. (See "Tests within a circuit"). As described in section "Safety" all ground connections of the scope are connected to safety ground including those of the component tester. As long as individual components are tested this is of no consequence.

The display can only be affected by the controls contained in the FOCUS/TRACE menu: A-Int., Focus, Trace rotation, HORIZONTAL position.

If components are to be tested which are parts of a circuit or an instrument those circuits resp. instruments must first be deenergized. If they are connected to the mains they must be unplugged. This will prevent a connection between scope and circuit via the safety ground which may affect the measurement.



**Do not test charged capacitors.**

The principle of the test is very simple: a sine wave generator within the scope generates a 50 Hz  $\pm 10\%$  voltage which is applied to a series connection of the test object and a resistor within the scope. The sine wave proper deflects in X direction, the voltage across the resistor which is proportional to the test current deflects in Y direction.

If the object contains neither capacitors nor inductors, there will be no phase shift between voltage and current, so a straight line will show up which will be more or less slanted, depending on the value of the object's resistance, covering appr. 20  $\Omega$  to 4.7 k $\Omega$ . If there is a short the trace will be vertical, i.e. (almost) no voltage produces already high current. A horizontal line will thus indicate an open, there is only voltage but no current.

Capacitors or inductors will create ellipses. The impedance may be calculated from the ellipse's geometric dimensions. Capacitors of approx. 0.1  $\mu$ F to 1000  $\mu$ F will be indicated.

- An ellipse with its longer axis horizontal indicates a high impedance (low capacitance or high inductance)
- An ellipse with its longer axis vertical will indicate a low impedance (high capacitance or low inductance)
- A slanted ellipse will indicate a lossy capacitor or inductor.

Semiconductors will show their diode characteristics, however, only 20 V<sub>pp</sub> are available, so the forward and reverse characteristics can only be displayed up to 10 V<sub>p</sub> in each direction. The test is a two-terminal test, hence it is not possible to measure e.g. the current gain of a transistor. One can only test B-C, B-E, and C-E. The test current is only a few mA, so the test will not harm ordinary semiconductors. (Sensitive devices like delicate hf transistors etc. should not be tested). The limitation to 10

Vp with bipolar transistors will suffice mostly as usual defects will show up.

The best method to verify whether a component is defective is the comparison to a good one. If the lettering of a component is not legible at least it is possible to see whether it is a npn or pnp transistor or which end of a diode is the cathode.

Please note that reversing the test leads will also invert the picture, i.e. turn it 180 degrees.

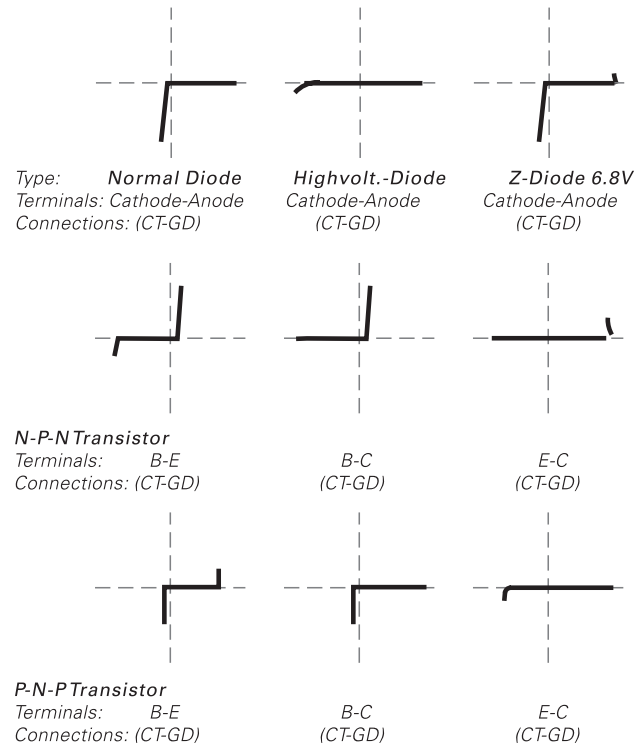

In most cases, e.g. with service and repair, it will be sufficient to receive a good/bad result (open, short). With MOS components the usual precautions are to be observed, but note, that except for a possible short MOSFETs and JFETs can not be sufficiently tested. Indications to be expected depend strongly on the kind of FET:

- With depletion type MOSFETs and all JFETs the channel will conduct if prior to testing the gate was connected to the source. The R<sub>dson</sub> will be shown. As this can be very low it may look like a plain short although the part is good!
- With enhancement type MOSFETs an open will be seen in all directions, as the threshold voltage G - S is not available. With power MOSFETs the antiparallel diode S - D can be seen.

Tests of components within circuits are possible in many cases but less indicative because other components may be in parallel. But also here the comparison with a good circuit might help. As both circuits must be deenergized it is only necessary to switch the test leads back and forth between both in order to localize a defective spot. Sometimes like with stereo amplifiers, push-pull circuits, bridge circuits there is a comparison circuit right on the same board. In cases of doubt one component lead can be unsoldered, the other one should then be connected to the ground lead. This is labelled with a ground symbol. The pictures show some practical examples:

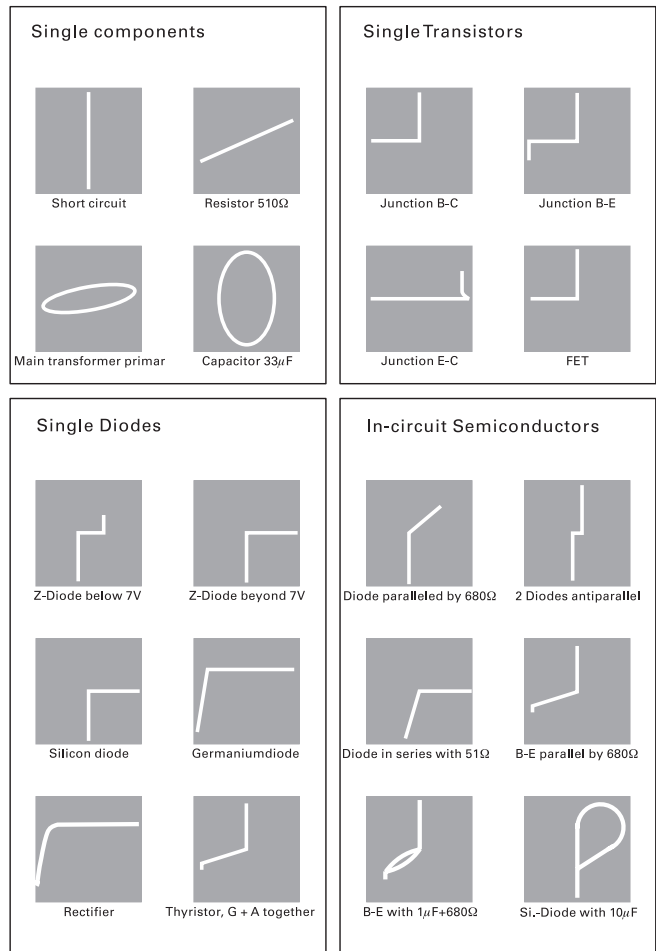

### Loading of new firmware

Under [www.hameg.de](http://www.hameg.de) the most recent firmware is available for downloading.

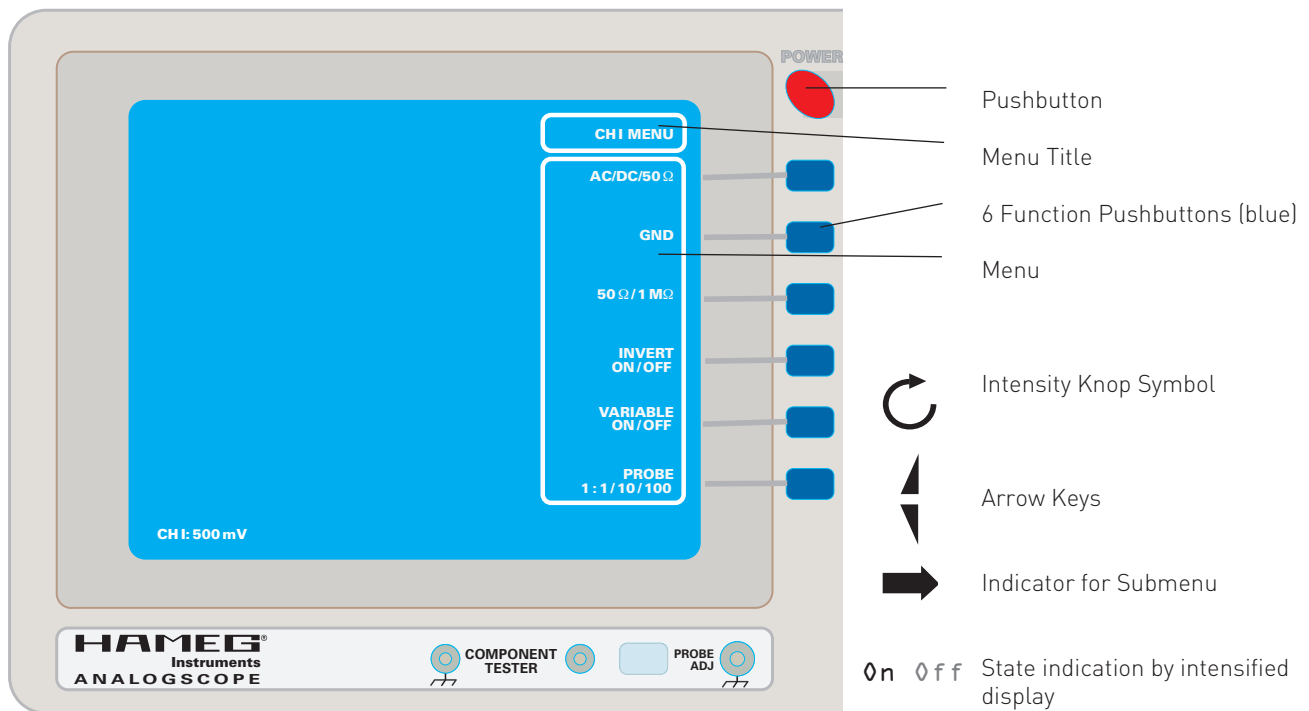

## General information concerning MENU

### Menu and HELP displays

Whenever a pushbutton is depressed the corresponding menu will be displayed except for: EXIT MENU/REMOTE OFF ④, AUTOSET ⑦, RUN-STOP ⑥ and MAG x10 ⑤. The menus offer options which may then be selected with the blue pushbuttons. All pushbuttons are on/off.

#### Exiting a menu:

- 1<sup>st</sup> The user may set a time after which the menu will be left. (SETTINGS ⑥ pushbutton >, Misc > Menu OFF.
- 2<sup>nd</sup> Before the time set as described has elapsed a menu can be exited by pressing EXIT MENU.
- 3<sup>rd</sup> Only manually if the function "Man" was selected ④.
- 4<sup>th</sup> Pressing the same pushbutton again.
- 5<sup>th</sup> Pressing another pushbutton.

If a menu shows a knob symbol ② this pertains to the INTENS knob ②. It allows to change settings. Also arrows may be shown which point to available submenus.

In some modes some pushbuttons or INTENS operations are meaningless and will hence not cause a menu display.



#### Please note:

**If a menu is shown some other information displayed in the readout may disappear, this will reappear immediately upon leaving the menu.**

Each menu is assisted by HELP texts, which can be called by pressing the HELP ⑧ and which will be also displayed by the readout. If HELP was called and the INTENS knob ② moved an

explanation of the actual INTENS knob ② function will be given. HELP will be left by pressing the pushbutton again.



#### Please note:

**During the display of help texts and menus in full size no signal display is possible.**

### Remarks

In operation all relevant measuring parameters will be shown in the readout, provided the readout was activated and its intensity is sufficient.

The front panel LEDs add to the operating comfort and give more information. In the end positions of the control knob an acoustical signal will sound.

Apart from the POWER ① pushbutton all control elements are scanned and stored. This allows to control the instrument from stored information.

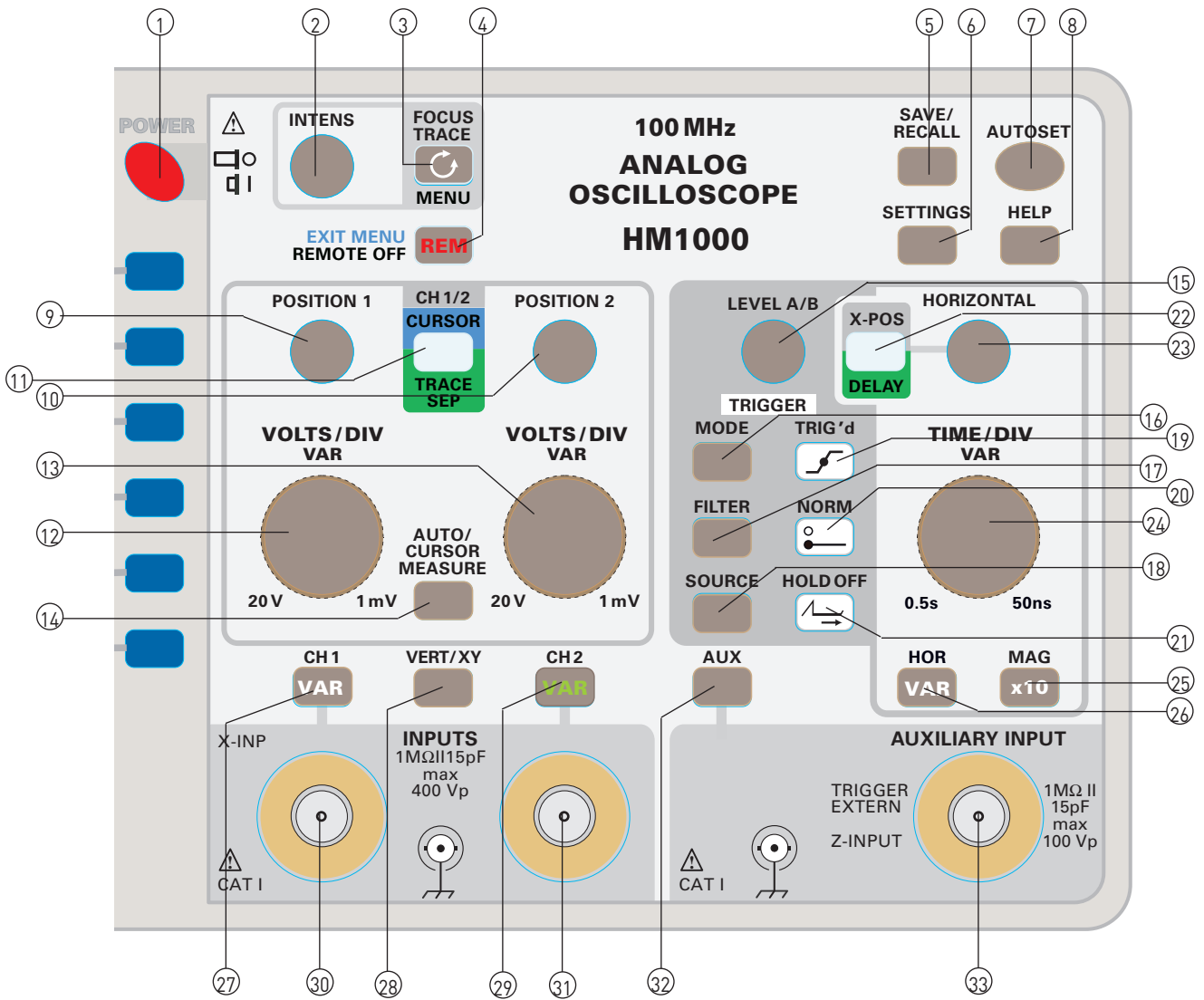

## Controls and Readout

The following description presumes that Component Test Mode is switched off.

### ① POWER

Mains switch with symbols **I** = ON and **O** = OFF.

After turning the scope on and after the warm-up time of the crt heater has elapsed the HAMEG logo, the instrument type and the version number are displayed. If prior to switching off the function "Quick Start" was selected [SETTINGS ⑥ > Misc] the above will not be displayed. Then the scope will assume the settings which existed before switching off.

### ② INTENS knob

This knob controls various functions:

**2.1** Trace intensity if the FOCUS/TRACE/MENU ③ pushbutton does not light the knob symbol . Turn left for decreasing and right for increasing.

**2.2** If the knob symbol  of the pushbutton ③ is illuminated the control will act for those functions displayed in the menu, which were activated.

### ③ FOCUS TRACE MENU (pushbutton)

If the knob symbol  will light after pressing this pushbutton the Int.Knob menu will be shown.

Depending on the operating mode the menu contains:

- A-Int.:** Intensity of the signal as displayed by time base A
- B-Int.:** Intensity of the signal as displayed by time base B
- RO-Int.:** Readout intensity
- Focus:** Focus for signal and readout
- Readout**

**On Off:** Turning the readout off will eliminate interference of the readout with the signal(s). The knob symbol will blink as long as the readout is off. Only menus and help texts will be shown.

**Trace rotation:** Trace rotation (see TR)

After turn-on the readout will always be on.

### ④ EXIT MENU/REMOTE OFF (REM) (pushbutton)

This pushbutton has two functions:

**4.1** If a menu is displayed pressing this pushbutton will turn it off. On condition a submenu is displayed, pressing this pushbutton switches back to the menu.

**4.2** Under remote control this pushbutton will be illuminated. After pressing the pushbutton, control is returned to the front panel.

## ⑤ SAVE/RECALL (pushbutton)

This pushbutton will open up a menu.

Under SAVE/RECALL the current instrument settings may be saved or settings saved earlier recalled. There are 9 nonvolatile memories available.

### 5.1 Saving the actual settings

Upon pressing the pushbutton the submenu "Front Panel Save" will be accessed. A memory number will be offered (1 to 9) which can be changed by the INTENS knob ②. By pressing "Save" all settings will be saved in the memory location the number of which was selected.

### 5.2 Recall the actual settings

In the submenu "Front Panel Recall" a memory number will be displayed (1 to 9) which can be changed with the INTENS knob ②. Pressing the pushbutton "Recall" causes loading of the settings stored.

## ⑥ SETTINGS (pushbutton)

Pressing this pushbutton will open the SETTINGS menu which offers the following submenus:

### 6.1 Language

In this submenu the language can be selected: English, German, French are available for choice.

### 6.2 Misc (Miscellaneous)

#### 6.2.1 Contr. Beep On Off

Switches the acoustical signal ON or OFF, which informs about CW or CCW positions of knobs.

#### 6.2.2 Error Beep On Off

Will turn the acoustical error signal ON or OFF.

#### 6.2.3 Quick Start On Off

In off the HAMEG logo, the type and the version number will not be shown, the instrument will be ready immediately.

#### 6.2.4 Menu Off time

With the INTENS knob ② the time of menu display may be determined. EXIT MENU will terminate a menu on the spot.

### In "Man." mode the menu can be left:

- by pressing EXIT MENU.
- by pressing another pushbutton.
- by pressing the same pushbutton again with which the menu was called.

### 6.3 Interface

If an interface is build in, this menu shows its parameters which can be selected as usual.

## ⑦ AUTOSET (pushbutton)

Choosing AUTOSET will cause an automatic instrument setting, dependent upon the signal proper which selects positions, signal amplitude and time base for a reasonable display. The choice of analog or DSO mode will not be affected. In component test mode (available only in analog mode), XY mode, or ADD automatically dual channel mode will be selected. If dual channel or Ch1 or CH2 were previously chosen this will remain.

AUTOSET will further set the intensity to an average value if it was set too low. If a menu was opened it will be turned off by

AUTOSET. During the display of HELP texts AUTOSET is not available.

## ⑧ HELP (pushbutton)

Pressing the HELP pushbutton will turn the signal display off and display the help text.

If a menu was opened the help text will refer to this menu resp. to the special menu or submenu option selected. If a knob is moved another help text referring to this knob will appear. Press HELP again to deactivate the text.

## ⑨ POSITION 1 (knob)

This knob can assume various functions which depend upon the operating mode, the functions selected with the CH1/2-CURSOR-TRACE SEP-pushbutton ⑩ and the menu option selected.

### 9.1 Y-position

#### 9.1.1 Y-position CH1

POSITION 1 will set the Y-position of CH1 provided there is YT-mode and the pushbutton CH1/2-CURSOR-TRACE SEP-pushbutton ⑩ is not illuminated.

#### 9.1.2 Y-position of 2<sup>nd</sup> time base B (TRACE SEP).

The POSITION 1 control will assume the function of Y-position control of the signal displayed by time base B in alternate time base mode after the following procedure. This is convenient in order to be able to separate the displays of the (same) signal with both time bases on the screen. Press the HOR pushbutton ⑳ > "Search". Press the CH1/2-CURSOR-TRACE SEP-pushbutton ⑩, select the function "TB B". The pushbutton will light up green.

### 9.2. X position in XY mode

POSITION 1 will function as X position control of CH1 in XY mode and provided the CH1/2-CURSOR-TRACE SEP-pushbutton ⑩ is not illuminated.

 **Note: The HORIZONTAL control ㉓ will also be functional in XY mode.**

### 9.3. CURSOR position

The POSITION 1 control will function as Y-position control of the cursors if the following conditions are met: The CURSOR display must have been activated (AUTO/CURSOR-MEASURE pushbutton ⑭ > Cursors > Cursors On pushbutton depressed). Press the CH1/2-CURSOR-TRACE SEP-pushbutton ⑩, select "Cursors" or "Cur. Track". The pushbutton will light up in blue.

 **Please note:**  
The function "Cur. Track" is only available if two cursors are indeed displayed, then both cursors can be moved simultaneously (tracking) without a change of their respective positions.

## ⑩ POSITION 2 (knob)

Also this control may assume diverse functions dependent upon the operating mode, the function selected via the CH1/2-CURSOR-TRACE SEP-pushbutton ⑩ and the menu item activated.

### 10.1. Y-position CH2

POSITION 2 will function as Y-position control of CH2 in Yt mode and if the CH1/2-CURSOR-TRACE SEP-pushbutton ⑩ is not illuminated.

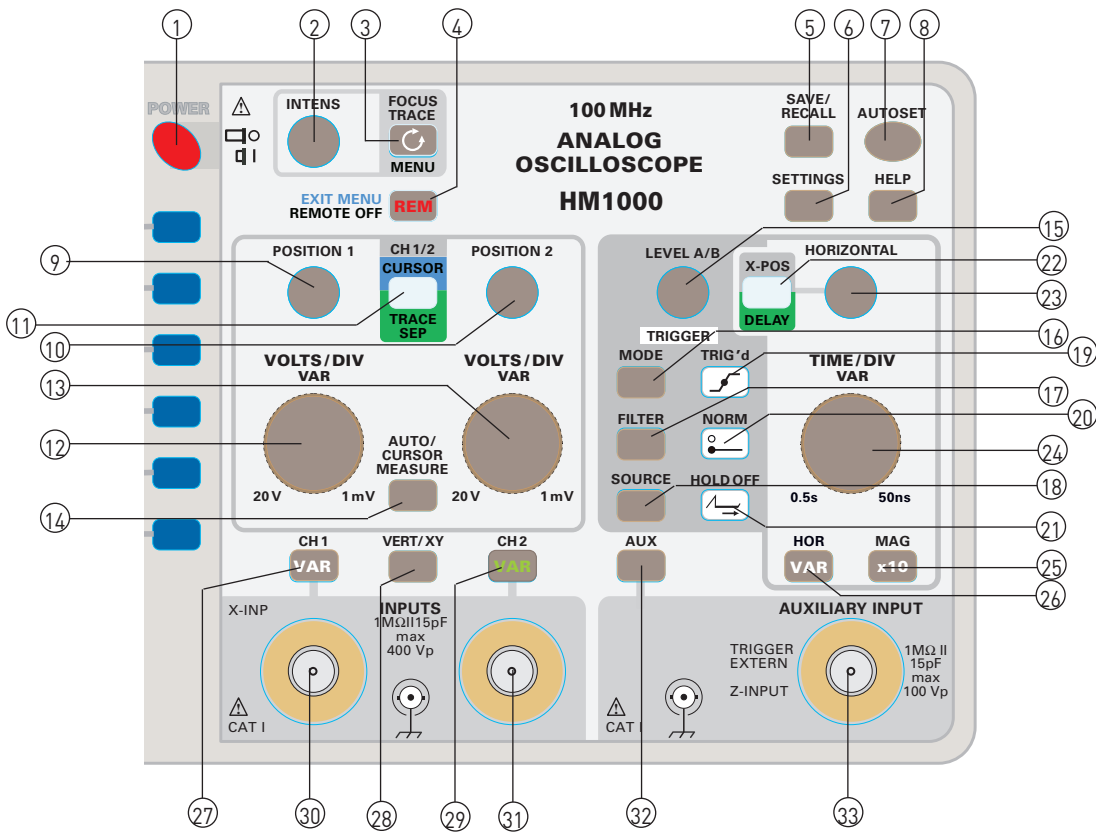

**10.2 Y-position of CH2 in XY mode**

POSITION 2 will function as the Y-position control of CH2 in XY mode provided the CH1/2-CURSOR-TRACE SEP-pushbutton ⑪ is not illuminated.

**10.3 Y-position of cursors**

The POSITION 2 control will function as Y-position control of the cursors if the following conditions are met: The cursors must be activated (Press AUTO/CURSOR-MEASURE pushbutton ⑭ > Cursors > Cursors On), press the CH1/2-CURSOR-TRACE SEP-pushbutton ⑪ select "Cursors" or "Cur. Track". The pushbutton will light up blue.

**Note:**

The function Cur. Track (cursor tracking) is only available if 2 cursors are on display. The cursors will then be moved simultaneously (tracking) without changing their respective positions.

**⑪ CH1/2-CURSOR-TRACE SEP-pushbutton**

This pushbutton calls a menu which allows to select the functions of the controls POSITION 1 and 2.

The pushbutton will signal the function activated corresponding to the front panel labelling:

- dark:** Y-position CH1 and CH2.
- blue:** Y-position of cursors.
- green:** Y-position of time base B display of signal(s)

**⑫ VOLTS/DIV-SCALE-VAR (knob)**

This knob is a double function CH1 control.

**12.1 Selection of vertical sensitivity**

Provided VAR on pushbutton CH1 ⑳ is not illuminated the sensitivity will be calibrated. Turning the control CCW will decrease, turning it CW will increase the sensitivity. 1 mV/cm to 20 V/cm can be selected in a 1-2-5 sequence. The readout will display

the calibrated sensitivity [e.g. "CH1: 5mV.."]. Depending on the sensitivity selection the signal will be shown with smaller or greater amplitude.



**Please note:**

This sensitivity selection is always active, e.g. also, if CH2 only was chosen. In that case CH1 may be used as trigger source.

**12.2 Variable control**

Select this function with the CH1 pushbutton ㉗ > Variable On. VAR on the CH1 pushbutton will light up. The readout will add a ">" to the sensitivity indication ("CH1>5mV..") in order to show that the sensitivity is now uncalibrated. The results of cursor measurements will be flagged accordingly. In this mode the sensitivity can be changed with the VOLTS/DIV-VAR control knob from 1 mV/cm to > 20 V/cm.

**⑬ VOLTS/DIV-SCALE-VAR knob**

This double function control belongs to CH2.

**12.1 Selection of vertical sensitivity**

The sensitivity will be calibrated provided VAR on the CH2 pushbutton ㉘ is not illuminated. Turning the control CCW will decrease, turning it CW will increase the sensitivity. The sensitivities can be selected from 1 mV/cm to 20 V/cm in a 1-2-5 sequence. The readout will show the sensitivity [e.g. "CH2:5mV.."]. Depending on the sensitivity the signal will be displayed with smaller or greater amplitude.



**Please note:**

The sensitivity control is always active, i.e. also if CH2 is not selected. CH2 may then still be used e.g. as a trigger source.

**13.2 Variable control**

The variable control is activated by pressing the CH2 pushbutton ㉘ > Variable On. VAR on the pushbutton will light



up. The readout will add the ">" preceding the sensitivity (e.g. "CH2 >5mV..") in order to indicate that the sensitivity is uncalibrated. The results of cursor measurements will be labelled accordingly.

In this mode the sensitivity may be changed continuously with the VOLTS/DIV-VAR control from 1 mV/cm to > 20 V/cm.

#### ⑭ AUTO/CURSOR MEASURE (pushbutton)

Pressing this pushbutton will open the menu "Measurement" which offers the submenus > "Cursors" and "Auto".

If the submenu Cursors was selected and a measuring mode "Cursors On" must be activated too, in order to generate the cursor line(s) on the screen. The measurement result will be shown in the readout!



#### Please note:

**In order to move the cursors it is necessary to press the pushbutton CH1/2-CURSOR-TRACE SEP ① and look for the menu "Pos./Scale". In this menu the selection of "Cursors" (long lines) or "auxiliary cursors" (short lines) or other symbols will determine which cursor lines/symbols can be moved by the POSITION 1 and 2 controls.**

#### 14.1 Cursors

Depending on the operating mode (Yt or XY) this submenu will offer various cursor measuring functions which will affect as well the cursor lines as their position.

##### 14.1.1 Cursors On Off

With "Cursors On" the CURSORS and the results of cursor measurements will be displayed by the readout in the top right corner of the screen. (e.g.  $\Delta V(\text{CH2}):16.6 \text{ mV}$ ). If a variable control was activated, the readout will indicate this by replacing the ":" by a ">".

##### 14.1.2 Meas. Type

If this function is activated one of the measurement modes offered may be selected with the INTENS knob ②. In most cases the unit going with a mode will be shown also.

##### 14.1.3 Unit

In the modes "Ratio X" and "Ratio Y" the INTENS knob symbol  will be shown in addition to a unit, this may then be used to change the unit.

##### "rat" (ratio), display of ratios

In this mode the ratios of duty cycles or amplitudes may be determined with the CURSORS. The distance between the long CURSOR lines is equal to 1.

##### "%" (percent), display of percentages

The distance between the long CURSOR lines is equal to 100%. The result will be determined by the distance of the short auxiliary cursor line to the long reference line (lower resp. left), if appropriate with a negative sign.

##### "°" (degree), measurement of degrees

The distance between the long CURSOR lines is equal to 360 degrees and must be exactly as long as a signal period. The measurement result will be determined from the distance between the reference line to the short auxiliary cursor line. If appropriate with a negative sign. For further information please consult "Measurements of phase differences in dual channel mode (Yt)" in the section "First time operation and presettings".

##### " $\pi$ "

One period of a sine wave is equal to  $2\pi$ , hence the distance between the two long CURSOR lines must be set to one period. If the distance between the reference line and the short CURSOR line equals 1.5 periods, " $3\pi$ " will be displayed. If the short cursor line is left of the reference line a negative sign will be shown.

##### 14.1.4 Respect

It may be necessary to determine for which signal resp. channel the CURSOR measurement shall be valid. This is signalled by showing the INTENS knob  signal next to the channel number. After selection of the signal source, the CURSOR lines must then be positioned to the signal or portions of it displayed by this channel.

##### 14.2 Auto

Depending on the operating mode this submenu offers various automatic measurements of the trigger signal. The following conditions must be met:

- For frequency or period measurements sufficient trigger signals must be available. Use normal triggering for signals < 20 Hz. Please note that signals of very low frequency may require seconds to complete one measurement.
- In order to measure DC or the DC content of a signal the input channel as well as the trigger must be set to DC coupling.

##### Further notes:

- Due to the limited frequency response of the trigger channel the accuracy will decrease with increasing frequency.
- The frequency responses of the vertical channel and the trigger channel differ substantially, this may affect the signal display.
- When measuring very low frequency signals the display will follow the signal.
- When measuring pulse signals there may be an influence of the duty cycle or the slope selected on the accuracy of the result.
- The signal must remain within the graticule area, i.e. the input amplifiers must not be overdriven.



#### Please note:

**Complex signals should be measured using the CURSORS.**

##### 14.2.1 Auto On Off

If Auto is On the result of the automatic measurement will be shown in the readout in the top right corner. (e.g.  $\text{dc}(\text{Tr}):100\mu\text{V}$ . (Tr) points out that it refers to the trigger signal. Sometimes a "?" will be displayed, this indicates that there is no or an insufficient signal.

If a variable is activated and thus the sensitivity or time base uncalibrated the ":" will be replaced by a ">" symbol.

##### 14.2.2 Meas. Type (measurement type).

The measurement type can be selected with the INTENS knob ②.

##### 14.2.3 Respect

Tr indicates that the measurement is done with respect to the trigger signal. If e.g. the CH1 signal is used for triggering, the result will be with respect to that signal.

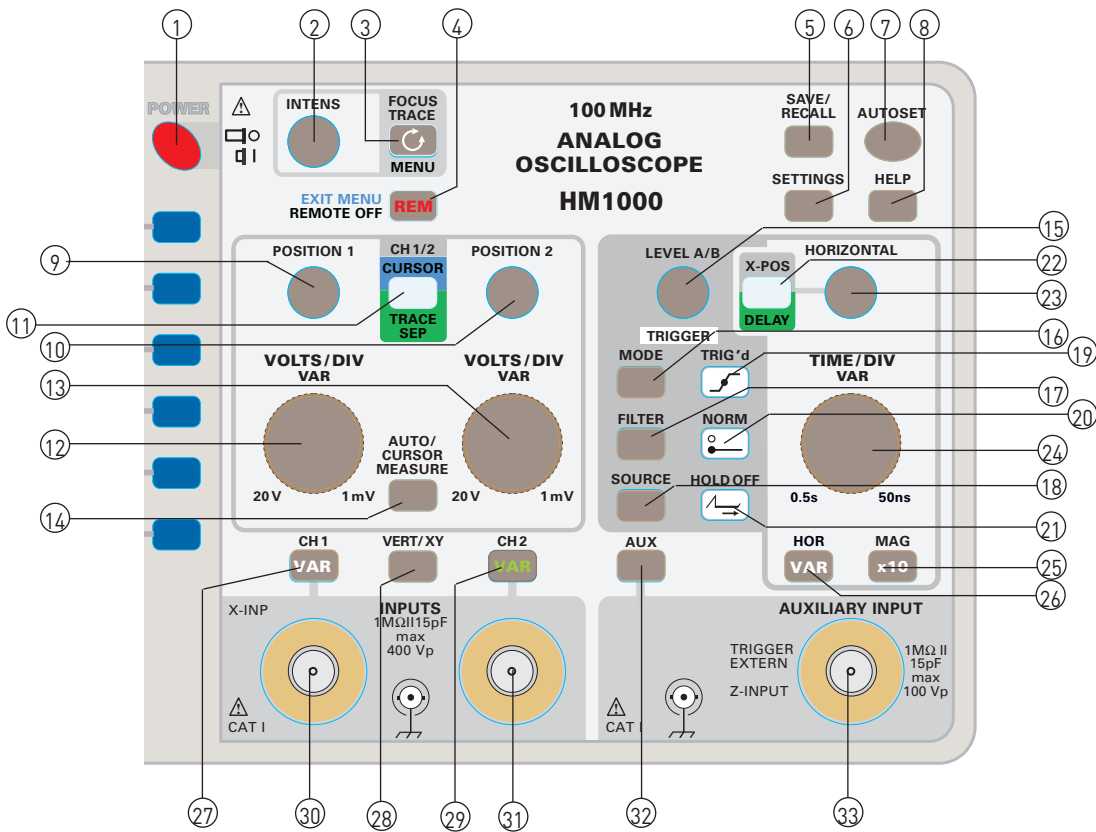

15 LEVEL A/B (knob)

The LEVEL control allows to set the trigger level, i.e. the voltage resp. signal level, which will generate a trigger to start the time base whenever the signal passes that level. In most Yt-modes the readout will show a symbol the vertical position of which indicates the signal point which will trigger. The trigger symbol will not be shown those modes where there is no direct relationship between trigger signal and trigger point.

In normal trigger mode the LEVEL control will move the trigger symbol anywhere. In automatic peak-to-peak detection mode the level can only be selected between the signal's peak values.

The movement of the trigger symbol is vertical only. The range of this symbol is limited in order to prevent that this symbol will overwrite other readout information. As soon as the trigger symbol leaves the graticule its form will change, this change signals in which direction the trigger symbol left the graticule.

Depending on the time base mode the LEVEL control will affect the time base A or B triggering. Press the HOR pushbutton 26 in order to select the time base mode in the "Time base" menu. In "Search" mode (alternate time base mode) the last trigger level setting for time base A will remain valid (graticule left) if time base B is switched to triggered mode. (Menu "Time base": set B trigger to positive or negative slope). Thereafter the LEVEL A/B control will control the time base B trigger, a second trigger point symbol will be shown and marked with "B".

16 MODE (pushbutton)

Pressing this pushbutton will open the "Trigger" menu, where AUTO and NORMAL can be selected. Choosing "Slope" will allow to trigger on any signal shape. For video signals select "Video" and press the FILTER pushbutton 17 in order to find a choice of special trigger modes for composite video signals. In XY mode the pushbuttons MODE 16, FILTER 17 and SOURCE 18 are disabled as there is no triggering in XY mode.

16.1 Auto (trigger)

Automatic triggering (Auto) is active if the NORM display 20 is not illuminated. In "Auto" the time base will be periodically started even if there is no signal or when no triggers are generated because the settings are incorrect. Signals of < 20 Hz can not be triggered as the automatic start will have occurred before the signal arrived. Automatic triggering is possible with or without peak detection. The LEVEL A/B 15 control will be active in both modes.

In peak detection mode the range of the level control is limited to the peak-to-peak voltage of the signal. Without peak detection any level can be set. If the trigger level is set such that no triggers are generated the automatic triggering will nevertheless start the time base. The signal will thus remain visible but will be untriggered.

Whether peak detection is active or not depends on the mode and the settings in "FILTER" (trigger coupling). The mode active will be shown by the behaviour of the trigger point symbol when turning the LEVEL knob.

16.2. Normal (trigger)

If the NORM-LED 20 lights up normal triggering was selected. In normal trigger mode both the peak detection and the automatic time base start will be disabled. Hence if there is no sufficient trigger signal the screen will remain dark in analog mode. In this mode there is no lower frequency limit for signals.

17 FILTER (pushbutton)

After this pushbutton is depressed it will depend on the settings chosen in MODE 16 (Edge, Video) which menu will be offered. In XY mode the pushbuttons: MODE 16, FILTER 17 and SOURCE 18 are disabled as XY displays can not be triggered.

17.1 Menu: Slope

The menu "Edge" will appear if "Edge" was selected in the "Trigger" menu to be called with MODE 16 pushbutton and after

the FILTER ⑦ pushbutton was depressed. For further information see "Trigger coupling" (Menu "FILTER") under the heading "Triggering and time bases" and the instrument specifications. The following settings are available:

#### 17.1.1 Trig. Filter

- **AC:** The trigger signal is AC coupled via a large capacitor in order to reach a low cut-off frequency.  
**Readout:** "Tr:Source, Slope, AC"
- **DC:** The trigger signal is DC coupled. No peak triggering is possible.  
**Readout:** "Tr: Source, Slope, DC"
- **HF:** AC coupling with a small capacitor suppressing low frequency signals. Hence the signal display and the trigger signal derived are not any more identical. The trigger point symbol is switched off. As a combination of HF coupling and LF or Noise Reject is not meaningful both menu options will not be shown.  
**Readout:** "Tr:Source, Slope, HF".
- **LF:** The trigger signal is sent through a low pass in order to suppress high frequency components. As this will already suppress hf the noise rejection mode will be set to OFF automatically.  
**Readout:** "Tr:Source, Slope, AC or DC, LF".
- **Noise Reject:** Noise rejection (reduction) means a reduced trigger amplifier bandwidth and consequently less trigger signal noise.  
**Readout:** "Tr:Source, Slope, AC or DC, NR".

#### 17.1.2 Slope

SLOPE determines whether the rising or falling portion of a signal shall trigger, the level is set with the LEVEL A/B ⑤ control.

In BOTH MODE both slopes will trigger. This allows e.g. the display of eye diagrams.

### 17.2 Menu: Video

In order to reach the menu "Video" proceed as follows: Press MODE ⑩ to open the "Trigger" menu, select "Video", then press the FILTER ⑦ pushbutton. Further information can be found under "Video" (tv signal triggering) in the chapter "Triggering and time bases" and in the instrument specifications. The following settings are available:

#### 17.2.1 Frame, Line.

Depending on the setting chosen triggering will be on frame or line sync pulses. The selection will also affect other menu items.

**Readout:** "Tr:Source, TV".

##### 17.2.1.1 Frame

- **ALL:** In this mode the sync pulses of each half frame can trigger.
- **Even:** In this mode only the sync pulses of even half frames can trigger.
- **Odd:** In this mode only the sync pulses of odd half frames can trigger.

##### 17.2.1.2 Line.

- **All:** In this mode all line sync pulses can trigger.
- **Line No:** The line number with its line pulse that is used for triggering can be selected with the INTENS knob ②.
- **Line min:** One pushbutton operation will be sufficient to switch back to the lowest possible line number.

#### 17.2.2 Norm

The pushbutton allows the selection of the US standard of 525 lines and 60 Hz or the European standard with 625 lines and 50 Hz. With any change of standard the line number will be automatically changed, too.

#### 17.2.3 Polarity

Composite video signals may have both polarities. Selection of the right polarity is vital as the scope should be triggered by the sync pulses and not the video content.

Positive polarity is defined by the video content being more positive than the sync signals and vice versa.

If the polarity was wrongly selected there will be no triggering at all, an untriggered display or no signal capture.

### ⑩ SOURCE (pushbutton)

Depressing this pushbutton will call various menus depending on the previously selected mode (MODE ⑩ pushbutton): Edge and Video. In XY mode the pushbuttons: MODE ⑩, FILTER ⑦, SOURCE ⑩ are disabled as XY displays can not be triggered.

#### 18.1 Edge-/Video-Trigger

In the "Trigger SOURCE" menu the source is selected from which the trigger signal is to be taken. The options depend on the actual mode of the scope.

##### 18.1.1 CH1

Conditions: EDGE or VIDEO selected.

CH1 will then be the trigger source, no matter whether it is displayed or not.

**Readout:** "Tr:CH1, (Slope), Filter (TV)".

##### 18.1.2 CH2

Conditions: EDGE or VIDEO selected.

CH2 will then be the trigger source, no matter whether it is displayed or not.

**Readout:** "Tr:CH2, (Slope), Filter (TV)."

##### 18.1.3 Alt. 1/2

Conditions: EDGE-Triggering. Alternate triggering with the signals from channels 1 and 2 as described in the section "Alternate Trigger" of chapter "Triggering and time bases". Please note that in this trigger mode the apparent time relationships between the two signals on the screen are meaningless and misleading, the relative position of the two signals depends only on their shape and the trigger level selected.

In dual channel mode (DUAL) alternate triggering is only possible in conjunction with alternate dual channel operation. If previously dual trace chopped mode was selected (VERT/XY ③ pushbutton) > DUAL chop it will be automatically changed to alternate mode when alternate triggering is selected. After "Alt. 1/2" is turned off dual trace chopped mode may be selected again.

**Readout:** "Tr:alt, Slope, Filter".

##### 18.1.4 External

In this mode the trigger signal comes from AUXILIARY INPUT ③. **Readout:** "Tr:alt, Slope, Filter".

##### 18.1.5 AC Line

The trigger signal is taken from the line which feeds the scope. See also the section "Line triggering" in the chapter "Triggering and time bases".

**Readout:** "Tr:alt, Line, Slope".

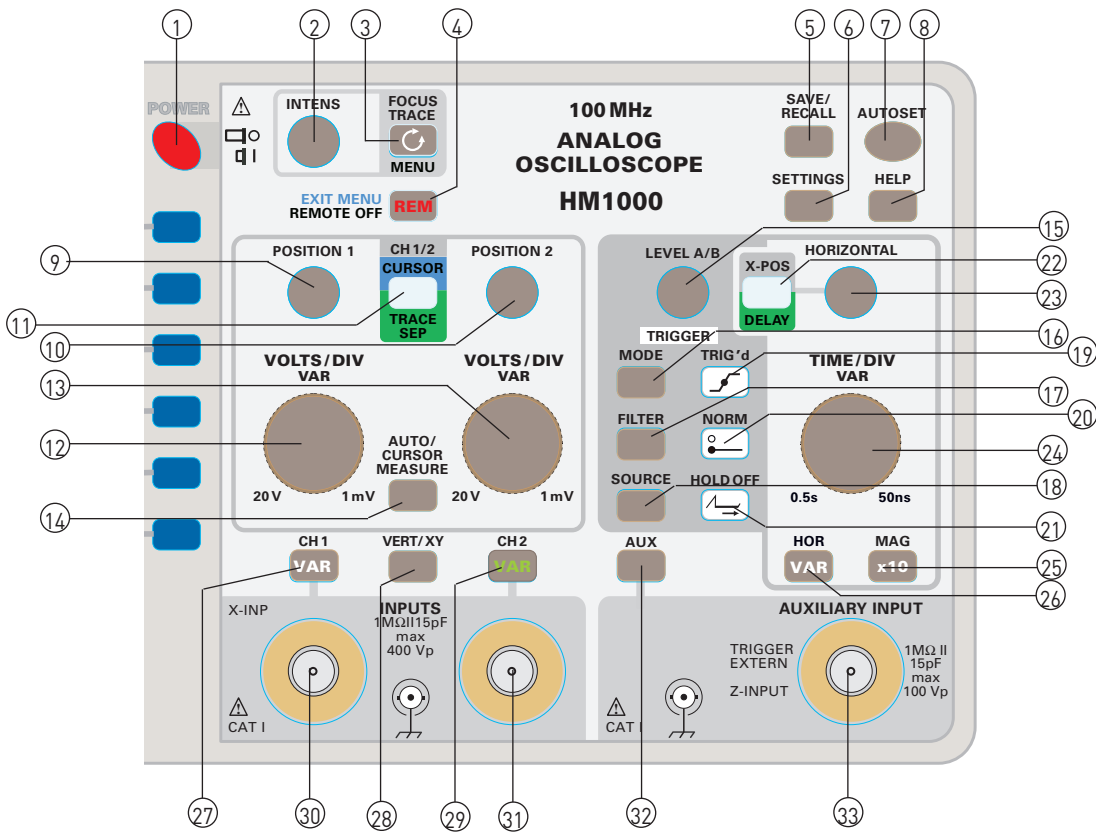

19 TRIG'd display (not in XY-mode)

This LED will light up if the time base receives a trigger signal. It depends upon the trigger signal whether the LED will just blink or remain illuminated.

20 NORM display

This display will light up provided "Auto" triggering was not selected. The mode can be selected in the "Trigger" menu called by pressing (MODE 16). The light points out that the screen will remain dark as long as there is no sufficient trigger signal.

21 HOLD-OFF display

This display will light up if the hold-off time was set to > 0% in order to indicate that the longer than minimum hold-off time may cause a lower rep rate of the time base and thus a darker display. Setting the hold-off time requires pressing the HOR pushbutton 25 which calls the menu "Time base". Only the time base A hold-off time may be changed.

See the section "Hold-off time setting" in the chapter "Triggering and time bases".

22 X-POS DELAY (pushbutton)

This pushbutton allows to change the function of the HORIZONTAL knob 23.

The pushbutton signals the actually selected function in accordance with the front panel lettering:

- dark: X-position control
- green: Delay time control

22.1 X-POS

If the pushbutton is dark the HORIZONTAL-knob 23 functions as X position control, i.e. it moves the signal display horizontally.

The position control is especially useful when the magnifier (MAG x 10 25) is switched on. The magnifier will magnify the display 10 times around the screen centre, with the control the portion of the signal to be studied can be shifted on-screen.

22.2 DELAY

In order to change the function of the HORIZONTAL-knob 23 to DELAY proceed as follows:

Press the HOR pushbutton 26 which will present the "Time base" menu, select "Search" or "B only", then the function of the knob will be changed if the pushbutton is depressed. It will light up to show that the knob is now the delay time control.

In SEARCH mode both traces (time base A and B) alternate. Unlike the former time base A ONLY mode, a sector with higher intensity is visible on the A trace. This sector can be moved continuously by the delay time control. The time between the A trace start and the beginning of the intensified sector is the delay time. This information is also displayed in the readout ("Dt:...") and is an aid to find the position of the intensified sector which may be very small. If time base "B only" is chosen the intensified sector is no longer visible, but the DELAY function still can be used.

Without activated "B Trigger" function, the B time base will be started after the A time base delay time "elapsed".

23 HORIZONTAL knob

The various functions of this knob depend on the operating mode and are described under X-POS DELAY 22 pushbutton.

24 TIME/DIV.-VAR knob

This knob is normally used as the time base speed selector, but has also other functions dependent on the operating mode. In XY mode this control is disabled.

### 24.1 Time base A time/cm selection

This function is active if in the "Time base" menu (HOR pushbutton ⑨) "A only" was selected and the option "A variable On Off" was set to Off.

Turning the knob CCW will decrease, turning it CW will increase the time base speed. The time base speed may be chosen between 500 ms/cm... 50 ns/cm in a 1-2-5 sequence and will be calibrated. The readout will show the setting (e.g. "A:50ns").

### 24.2 Time base B time/cm selection

This function is active if in the "Time base" menu (HOR pushbutton ⑨) "Search" or "B only" was selected and the option "B variable On Off" was set to Off.

Turning the control CCW will decrease, turning it CW will increase the time base speed. The speed can be selected between 20 ms/cm.. 50 ns/cm in a 1-2-5 sequence and will be calibrated. The readout will show the speed (e.g. "B:50ns").

The time base B allows to display portions of the time base A display on an expanded time base scale. This implies that the speed of TB B must always be greater than that of TB A. Therefore with the exception of 50 ns/cm TB B can not be set to the same speed as TB A.

Further information is available in the section "Time base B (2<sup>nd</sup> time base/Delay/Triggering" in the chapter "Triggering and time bases".

### 24.3 Variable

The TIME/DIV-VAR control may also be used to change the time base speed continuously but uncalibrated. "VAR" will light up on top of the HOR pushbutton ⑨ in order to warn that the time base is uncalibrated and the knob has now that function.

In order to arrive at that function press HOR ⑨ which calls the "Time base" menu. Depending whether time base A or B is selected either "A variable On Off" or "B variable On Off" will be shown. The function pushbutton can then be used to select On/Off.

In order to point out that the time base is now uncalibrated the readout will replace ":" by ">" preceding the time/cm. (e.g. "A>500ns" and "B>200ns"). Also the results of cursor time/period measurements will be marked that way.

### ⑨ MAG x10 (pushbutton)

Pressing this pushbutton will turn on the x 10 magnifier. No menu will be shown.

If "x10" is illuminated on the MAG pushbutton the magnifier is activated. The adjusted time/cm will be shown in the top left readout.

Depending on the time base mode turning on the magnifier will have these effects:

#### 25.1 "Time base A only"

The display will be expanded around the screen centre by a factor of 10, the time/cm adjusted accordingly.

#### 25.2 "Search" (A and B times bases alternated)

The time base A speed will not be affected. The time base B speed will be increased by a factor of 10, hence the time base B display will be expanded 10-fold in X-direction.

#### 25.3 "B only":

The time base B speed will be increased by a factor of 10 and the display hence expanded 10-fold in X-direction.

### ⑨ HOR (pushbutton)

This pushbutton will open the "Time base" menu the contents of which depends on the operating mode selected.

#### 26.1 A only

Only the time base A will be operative. The readout will thus only show "A..." in the top left corner. The TIME/DIV-VAR knob will set the time base A speed. With the MAG x10 pushbutton the display may be expanded around the screen centre, increasing the speed by 10. If the mode is changed from time base A to "Search" or "B only" all settings of time base A remain intact including triggering.

#### 26.2 Search

This mode implies alternate time base operation. The readout will show the speeds of both time bases ("A..." and "B..."). The TIME/DIV-VAR knob will set the time base B speed.

In alternate time base mode part of the time base A display will be intensified. The horizontal position of the intensified portion may be shifted using the HORIZONTAL ⑨ knob, provided its function was set to DELAY, this is the case if the X-POS DELAY pushbutton ⑨ is illuminated. The length of the intensified sector is determined by the speed of time base B and is equal to the run time of B. Hence this intensified portion of A will be spread over the full screen as displayed by B and thus expanded. The Y-position of the signal is the same when displayed with either A or B. This means, however, that both displays will be written over each other. In order to separate them on the screen for better readability an artificial Y offset may be added to the time base B display. Press the CH1/2-CURSOR-TRACE SEP pushbutton ⑩ which calls the "Pos./Scale" menu. Press the function pushbutton TB B, this will cause the POSITION 1 knob to act as the position control for the time base B display. (Trace separation.) See also 9.1.2 Y-position 2<sup>nd</sup> time base. This function makes sense only in "Search" and is unavailable in any other. Also in "Search" the 10x magnifier is available by pressing the pushbutton MAG x10 ⑨. The magnifier will affect solely time base B.

#### 26.3 B only

In this mode only time base B will be displayed, the readout will thus only show the time base B speed in the top left corner ("B..."). The TIME/DIV-VAR knob will set the time base B speed. The 10x magnifier is available by pressing MAG x10 ⑨ and will expand the display around the screen centre.

#### 26.4 B trigger – $\sqrt{\quad}$ Edge

In this mode time base B will not start immediately after the delay time set elapsed, but it will be only set ready waiting for a signal trigger. This has the advantage that any jitter is removed, but the delay time adjustment will now only have the effect that the time base B display will jump from signal period to period. In this setting a positive slope will trigger.

The (trigger) LEVEL A/B ⑩ knob will set the trigger level for B. Only normal triggering and DC-coupling are possible. All parameters of time base A remain stored and preserved. (LEVEL, auto or normal, Slope, coupling). In addition to the delay time ("Dt:...") also the B trigger parameters are shown in the readout: "BTr:slope, DC". In SEARCH mode the trigger point symbol will be preceded by "B". As mentioned changing the delay time will not cause a continuous move of the intensified portion of the time base A display and the time base B display, but jumps from signal period to period.

If the trigger level symbol of time base B is shifted outside the signal representation by time base A there will be no triggering of time base B any more and thus no time base B display. The same holds in time base B only mode.

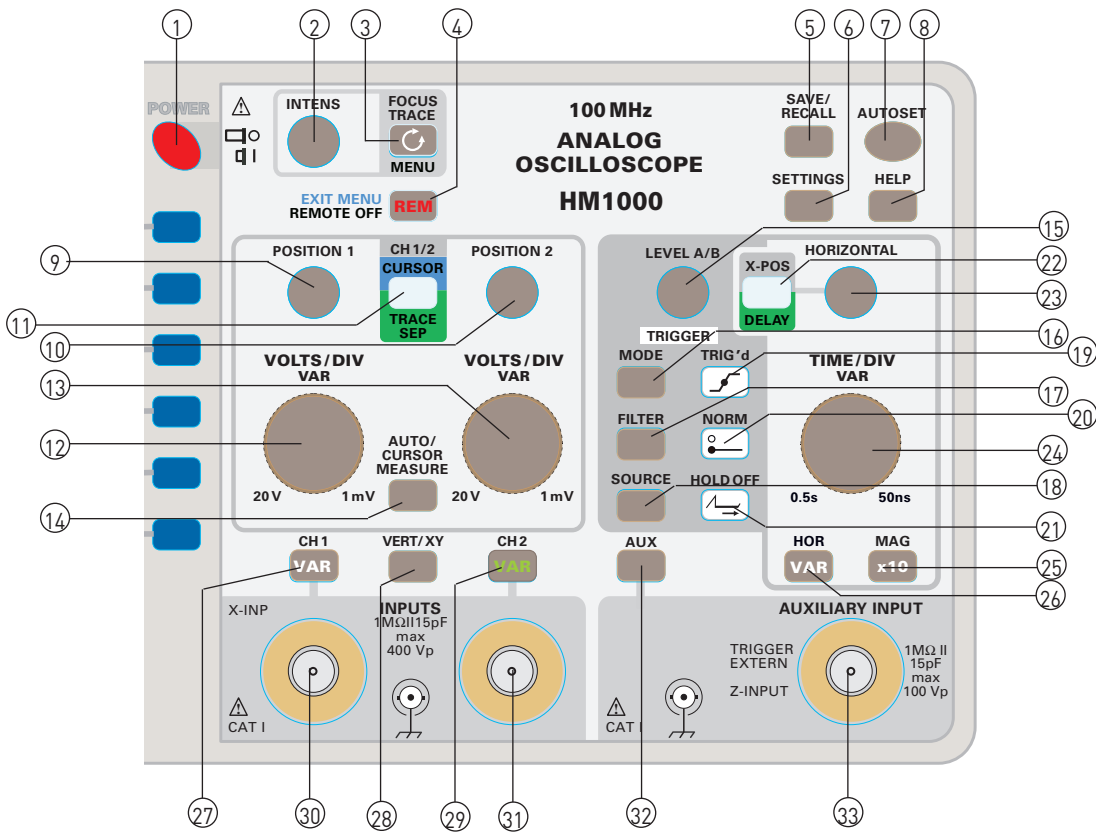

**26.5 B trigger –  $\setminus$  Edge**

Except for the negative edge the function is identical to the one described above [26.4].

**26.6 B trigger – OFF**

Time base B will be started upon the end of the delay time set. The delay time can be changed continuously in this mode which can be watched on the intensified sector of the time base A display. The disadvantage here is that with very long delay times jitter of the time base B display may crop up.

As time base B is not operated in the signal triggered mode the controls for time base B trigger will be disabled resp. are only for time base A.

**26.7 A variable – On Off**

If "On" was selected the TIME/DIV-VAR knob 24 will function as variable control for the time base A speed. Only in time base A only mode this option will be available in the menu. For a full description see "24.3 Variable".

**26.8 B variable – On Off**

If "On" was selected the TIME/DIV-VAR knob 24 will function as the time base B variable control. For a full description see "24.3 Variable".

**26.9 Holdoff ...%**

In this mode the hold-off time may be selected from 0 to 100 % with the INTENS knob 2. Values >0 extend the waiting time after a sweep before a new one can start and decrease thus the repetition rate which may darken the display. This is indicated by the HOLD OFF-LED 20 lighting up. The hold-off time is only valid for time base A.

Further information can be found in the section "Hold-off adjustment" in the chapter "Triggering and time bases".

**27 CH1 (pushbutton)**

This pushbutton opens the CH1 menu which contains the following options referring to CH1 30 input resp. to the signal on CH1.

**27.1 AC DC**

Pressing the pushbutton will switch from AC to DC or vice versa. The mode selected will be shown in the readout following the sensitivity setting: ~ is for AC and = is for DC.

**27.1.1 DC coupling**

The signal will be directly coupled, from the BNC connector via the attenuator to the vertical amplifier. The input resistance is 1 MΩ in all positions of the attenuator.

**27.1.2 AC coupling**

A capacitor is inserted between the BNC connector and the attenuator, blocking the DC content of the signal and creating a low frequency cut-off at approx. 2 Hz. This will affect the shape and amplitude of signals with low frequency content. If the DC content of the signal changes or the duty cycle of pulses the capacitor will charge or discharge, this will cause a momentary Y shift of the display.

**27.2 Ground On Off**

The pushbutton will either connect the amplifier to the signal or to ground. If set to Ground the readout will show a ground symbol following the sensitivity setting, at the same place where formerly the coupling was indicated. In the Ground position and with automatic triggering a trace will be visible, this is handy for setting the Y-position of it e.g. to the screen centre without disconnecting the signal. The readout will show a symbol (⊥) for 0 V which will be close to the vertical centre line of the graticule, it is the zero reference for any measurements. After switching back to the signal its ampli-

tude can now be determined with respect to the formerly set zero reference.

### 27.3 Invert On Off (unavailable in XY-mode)

This pushbutton will alternate between not inverted or inverted of the CH1 signal. The readout will indicate an inverted display by placing a bar above the CH1. The trigger signal derived from CH1 will not be affected by an inversion.

### 27.4 Probe submenu

Pressing the pushbutton will open the "CH1 probe" submenu.

#### 27.4.1 \*1 - \*10 - \*100 - \*1000

A selection of probe attenuation factors from 1 to 1,000 is possible. The value selected will be automatically taken into account regarding the sensitivity indicated and measurements.

#### 27.4.2 Auto

If Auto is selected HAMEG probes with automatic probe identification connectors will be recognized by the scope and the appropriate factor taken into account. The factor recognized will be indicated following AUTO.

Probes without that special connector will cause the display "auto \*1" and treated as 1:1 probes.

### 27.5 Variable On Off

If activated VAR on the CH1 pushbutton ⑳ will be illuminated. The readout will replace ":" by ">" (e.g. "CH1>5mV".) and this also in any cursor measurements pointing out that the sensitivity is uncalibrated.

The VOLTS/DIV-VAR knob ㉑ will function as variable which can change the sensitivity continuously between 1 mV/cm to > 20 V/cm.

### ㉒ VERT/XY (pushbutton)

This pushbutton switches the "vertical" menu on/off. This menu allows to select the operating modes of the vertical amplifiers.

### 28.1 CH1

If CH1 is selected only CH1 will be turned on, the mode is Yt. Also the readout will only display the parameters of CH1. (sensitivity, inverted/not inverted, coupling.) Although CH2 will not appear in the readout it may be used e.g. as a trigger input. Its controls are active but are not shown.

### 28.2 CH2

If CH2 is selected only CH2 will be active, it is Yt-mode, and only its parameters will be shown in the readout.

Although CH1 will not appear in the readout it may be used e.g. as a trigger input. Its controls are active but are not shown.

### 28.3 DUAL trace alt./chop

In dual trace mode both channels are turned on and the parameters of both are shown in the readout. Between the sensitivity indications there is an indication whether alternate "alt." or chopped "chp" mode is active. Normally, the mode will be automatically set by the time base speed selection, but it may be directly set using the function pushbutton. For time base speeds of 500 ms/cm to 500  $\mu$ s/cm chopped will be used, from 200  $\mu$ s/cm to 50 ns/cm alternate. This refers to unmagnified time bases.

Alternate is the preferred mode, at any time one channel is displayed for a full sweep, after each sweep the other channel has its turn. At slow sweep speeds this will cause annoying flicker, at still slower ones the channel switching becomes visible. Here, the

chopped mode steps in, both channels are switched at some high frequency so they are both visible at any sweep speed. This is, however, not appropriate for fast sweep speeds as the switching may become visible and may interfere with the proper signal display.

### 28.4 ADD

In ADD mode the signals of both channels are algebraically added and displayed as one sum signal. The Y-position can be changed with both position controls. If one channel is inverted the difference will be displayed. Only one "0V" symbol will be shown in the readout. The ADD mode will be indicated by placing a "+" symbol between the sensitivity indications of both channels.

Please note that the results of cursor measurements in this mode will only be correct if the sensitivities of both channels are identical, otherwise the readout will show "CH1<>CH2".

Automatic voltage measurements can not be performed in ADD mode. The readout will show "n/a" = not available.

As the trigger signals are taken off the inputs and not from the added signal there is no true reference for the trigger point symbol, the symbol will thus be switched off. However, the LEVEL A/B control ㉓ is active.

### 28.5 XY-mode

In this mode CH1 will move the trace in X direction, hence the readout will show "CHX..", CH2 will move the trace in Y direction, hence "CHY..." will be shown rather than "CH2...".

As the time bases are not involved in XY no time base related information will be shown. Also the trigger circuits are disabled so no trigger information is shown, either.

The magnifier MAG x10 ㉔ is disabled. The "0-Volt" symbols will be shown as triangles at the right hand graticule and above the sensitivities.

Both knobs, the HORIZONTAL ㉕ or the POSITION 1 ㉖ will move the trace horizontally. The Y-position is controlled by the POSITION 2 knob.

The CH1 signal can not be inverted, there is hence no menu item in the CH1 menu (CH1 pushbutton ㉗). The TIME/DIV-VAR ㉘ knob is disabled.

### 28.6 Bandwidth Full/20 MHz

This pushbutton will select full or 20 MHz bandwidth.

#### Full:

Full bandwidth will be the one given in the specifications.

#### 20 MHz:

Provided measuring modes allow full bandwidth (i.e.  $\geq 5$  mV/cm) this can be reduced to 20 MHz (-3 dB) in order to attenuate high frequency noise e.g. The readout will show BWL = bandwidth limited. The bandwidth limitation affects both channels.

### ㉙ CH2 (pushbutton)

This pushbutton opens the CH2 menu which offers the following options:

#### 29.1 AC DC

The pushbutton will alternate between AC and DC coupling. The readout shows a "~" or "=" symbol behind the sensitivity indication.

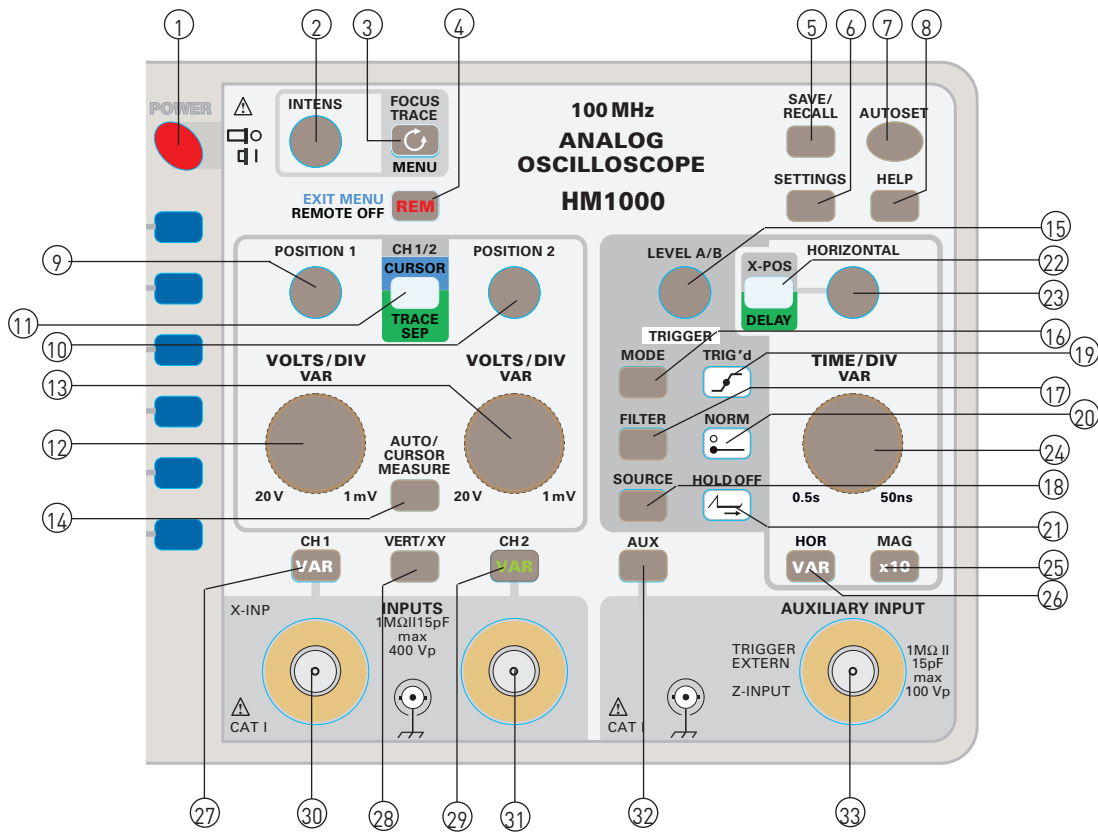

**29.1.1 DC coupling**

The signal will be directly coupled to the input amplifier via the BNC connector 30 and the input attenuator. The input resistance of the scope is a constant 1 MΩ irrespective of the sensitivity selected.

**29.1.2 AC coupling**

A capacitor is inserted between the BNC connector and the attenuator, thus the DC content of the signal is blocked and a high pass with a lower cut-off frequency of approx. 2 Hz is created. Low frequency signals will thus be more or less differentiated, hence their shape and amplitude affected.

If the DC content of the signal changes, e.g. the duty cycle of pulses, the capacitor must charge or discharge. This will cause a momentary Y shift of the display.

**29.2 Ground (GND) On Off**

The pushbutton will alternate between switching the amplifier input to the signal or to ground.

If the signal is disconnected resp. the amplifier input connected to ground the readout will show a ground symbol behind the sensitivity indication. In automatic trigger mode the trace will be visible in a reference position which can be used as a 0 V ground reference. The readout will show a symbol (⊥) for 0 V which will be close to the vertical centre line of the graticule, it is the zero reference for any measurements.

Referred to the trace position 0 V a DC voltage may be measured after the input was returned to the signal.

**29.3 Invert On Off**

The pushbutton will alternate between not inverted and inverted. An inverted signal will be indicated in the readout by bar above the channel symbol. The trigger signal taken from an input will not be affected.

**29.4 Probe menu**

This pushbutton opens the "CH2 probe" submenu.

**29.4.1 \*1 - \*10 - \*100 - \*1000**

A selection of 4 factors can be made, the factor chosen will be automatically taken into account for all displays and measurements.

**29.4.2 auto**

If "auto" was selected HAMEG probes with special probe identification connectors will be automatically identified and the appropriate factor taken into account. The probe factor identified will be shown behind AUTO.

Probes without that special connector will be treated as 1:1 probes (display "auto\*1"), for those the factor must be manually set.

**29.5 Variable On Off**

If the variable is on VAR on the pushbutton will be illuminated and indicates that the sensitivity is now uncalibrated, the readout will show ">" instead of ":" (e.g. "CH2>5 mV") The results of cursor measurements will be identified accordingly.

The VOLTS/DIV-VAR knob 13 of CH2 has now the function of variable, the sensitivity can be varied between 1 mV/cm to > 20 V/cm.

**30 INPUT CH1 (BNC connector)**

This is the CH1 signal input connector. In Yt mode it is a Y input, in XY-mode it is the X signal input. The connector housing is connected to the instrument housing and thus to safety ground. The ring around the connector is the probe identification contact, no voltage may be applied here.

**31 INPUT CH2 (BNC connector)**

This is the CH2 signal input connector. It is a Y input in Yt and XY mode. The connector housing is connected to the instrument housing and thus to safety ground. The ring around the connector is the probe identification contact, no voltage may be applied here.



### ③② AUX pushbutton

This pushbutton belongs to AUXILIARY INPUT ③③ (additional input). The menu called by this pushbutton will depend upon the actual operating mode.

**32.1** AUXILIARY INPUT ③③ is the external trigger input. For setting external triggering press SOURCE ①⑧, select the "Trig. Source" menu, then "External".

**32.2** If "External" triggering was not selected the menu "Z Input" will open up. If "Off" is chosen AUXILIARY INPUT ③③ has no function. If "On" is chosen it will function as Z input i.e. intensity modulation input. This input is destined for TTL signals, a voltage of  $>1 V_p$  will turn off the trace.

### ③③ AUXILIARY INPUT (BNC connector)

The input can serve as external trigger or Z-axis (intensity modulation) input.

The connector housing is connected to the instrument housing and thus to safety ground. The ring around the connector is the probe identification contact, no voltage may be applied here.

### ③④ PROBE ADJ. (connector)

A square wave signal of  $0.2 V_{pp}$  is available for the adjustment of 10:1 probes. The frequency can be selected by pressing the pushbutton PROBE ADJ. and calling the menu "Utilities". Further information may be found in the section "Probe adjustment and use" in the chapter "Operation and presets".

### ③⑤ PROBE ADJ (pushbutton)

This pushbutton produces the menu "Utilities", two options are available:

#### 35.1 COMP. Tester On Off.

If "On" is chosen a trace and a readout display "Component Tester" will appear.

In this mode the 4 mm connectors labelled "COMPONENT TESTER" become the measuring input. See also the chapter "Component Tester".

Choosing "Off" will return the instrument to all former settings.

#### 35.2 Calibrator 1kHz 1MHz

Depending on the setting the square wave signal frequency at the PROBE ADJ – socket is 1 kHz or 1 MHz.

### ③⑥ COMPONENT TESTER (sockets)

Both 4 mm diameter sockets serve as a two pole input for component test. Further information can be found under section Component Tester.

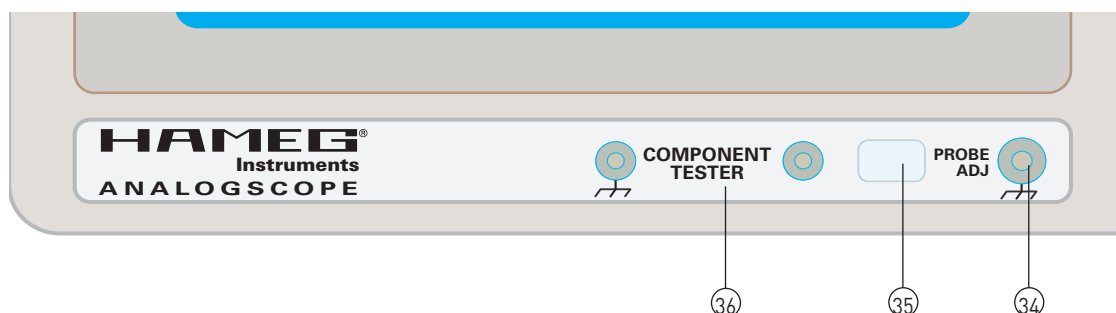





Oscilloscopes



Spectrum Analyzer

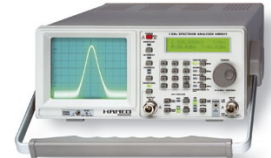

Power Supplies



Modularsystem  
Series 8000



Programmable Instruments  
Series 8100



authorized dealer

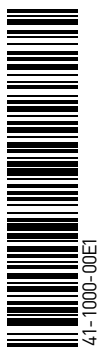

**w w w . h a m e g . d e**

Subject to change without notice  
41-1000-00E1 / 25-08-2005-gw  
© HAMEG Instruments GmbH  
A Rohde & Schwarz Company  
® registered trademark



DQS-Certification: DIN EN ISO 9001:2000  
Reg.-Nr.: 071040 QM

HAMEG Instruments GmbH  
Industriestraße 6  
D-63533 Mainhausen  
Tel +49 (0) 61 82 800-0  
Fax +49 (0) 61 82 800-100  
sales@hameg.de