

## DCM230 DC Energy Meter



- Measures kWh, W, V, A etc.
- Bi-directional measurement IMP & EXP
- Pulse output
- RS485 Modbus
- Din rail mounting 35mm
- DC shunt connection
- Class 1

***User Manual V1.5***

**2021**

Introduction

Eastron DCM230 series DC energy meters are designed for measuring and monitoring in DC systems. The din rail DC energy meters can measure of important DC parameters: Voltage, current, power and energy etc. It also support bi-directional measurement with pulse output. All data in the meter are accessible via RS485 using Modbus RTU. The meter has two versions working with AC or DC power supply. Input voltage range up to 300, 600, 1000V DC, and current inputs are flexible with DC shunt and current sensors. The multi-tariff version has a RTC equipped inside, it can provides multi-tariff information and monthly records.

## PART 1 Specification

Model list

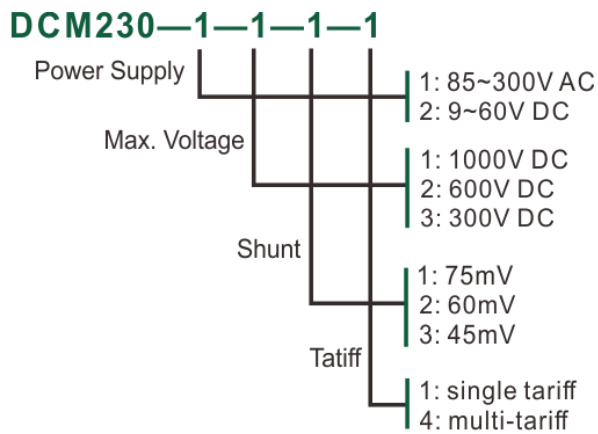

### General Specifications

Voltage DC Input	5~300V DC, 5~600V DC, 5~1000V DC
Auxiliary Supply	85~300V AC (DCM230-1) or 9-60V DC (DCM230-2)
DC Shunt Input	75mV (default) 60mV, 45mV (optional)
Current Range	0~2000A
Power consumption	≤ 2W / 5VA
AC voltage withstand	4400V/ 1min
Impulse voltage	6.4kV - 1.2/50μS waveform
withstand Pulse output	1, 10, 100, 1000imp/kWh (default)
Pulse duration	60, 100 (default), 200mS
Pulse output indicate	Total kWh/ import kWh/ export kWh
Display	LCD with backlit
Max. Reading	999999.9kWh
Weight	220g
Standard	GB/T 33708-2017
Accuracy class	1 (max. 1% measurement deviation)

### Unit Characteristics

The Unit can measure and display:

- voltage
- Currents
- Power
- Active energy imported and exported

Pulse output indicates real-time energy measurement. An RS485 output allows remote monitoring from another display or a computer.

### Shunt Primary Current

The unit can be configured to operate with primary current and secondary input.

Primary current range: 0~2000A.

Second input: 75mV in default (45mV, 60mV optional)

### RS485 Output for Modbus RTU

For Modbus RTU, the following RS485 communication parameters can be configured from the Set-up menu:

**Baud rate** 1200,2400, 4800, 9600,19200 bps

**Parity** none (default)/odd/even

**Stop bits** 1 or 2

**RS485 network address** *nnn* – 3-digit number, 001 to 247

#### Modbus™ Word order

Hi/Lo byte order is set automatically to normal or reverse. It cannot be configured from the set-up menu.

Set-up screens are provided for setting up the RS485 port.

### Pulse output

The unit provides a pulse output. The constant can be configured to below:

1000 imp/kwh

100 imp/kWh

10 imp/kWh

1 imp/kWh

Pulse width: 200/100(default)/60 ms.

Note: the relationship between pulse constant and CT1

CT1 setting	Default pulse constant	Settable pulse constant
1 – 20	1000 imp/kWh	1000,100,10,1 imp/kWh
21 – 200	100 imp/kWh	100,10,1 imp/kWh
201 – 2000	10 imp/kWh	10,1 imp/kWh

\*when the CT setting on meter is 2000A, the default pulse constant is 10 imp/kWh and it can be set to 10 imp/kWh or 1 imp/kWh.

\*Over-current alarm: Alarm will happen when the current is over the CT1 value set on the meter. The Alarm LED will stay solid and the corresponding register value will be changed. The user can read this register through communication to determine whether an overcurrent alarm has occurred.

The pulse outputs can be set to generate pulses to represent Import kWh/ Export kWh/ total kWh.

The pulse output is passive type, complies with IEC62053-31 Class A.

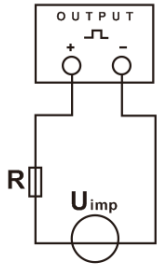

ATTENTION: Pulse output must be fed as shown in the wiring diagram below. Scrupulously respect polarities and the connection mode. Opto-coupler with potential-free SPST-NO Contact. Contact range:5~27VDC Max. current Input:27mA DC.

### Environment

Operating temperature	-25°C to +70°C
Reference temperature	23°C ± 2°C
Relative humidity	0 to 90%, non-condensing
Altitude	up to 2000m
Installation category	CAT II
Mechanical Environment	M1
Electromagnetic environment	E2
Degree of pollution	2



### Mechanics

Din rail dimensions	36x99x63 (WxHxD) DIN 43880
Mounting	DIN rail 35mm
Sealing	IP51 (indoor)
Material	Self-extinguishing UL94V-0

## PART 2 Operation

### Initialization Display

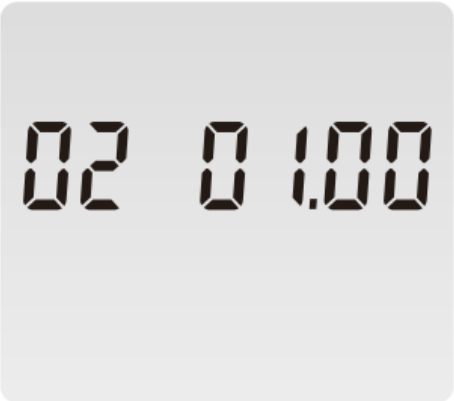
When it is powered on, the meter will initialize and do self-checking.

 <p>The display shows the following text and icons from top to bottom:          ΣT8IMPEXPMD1L L2          888.88.88          PF Hz MkVArh MkWh          Signal strength bars, a bell icon, a clock icon, a battery icon, and a lock icon.</p>	<p>Full Screen (stay 2s)</p>
 <p>The display shows the text: 02 0 1.00</p>	<p>Software Version (stay 2s)</p>
 <p>The display shows the text: Add 001</p>	<p>Current Modbus address (stay 2s)</p>

<p>The LCD display shows the characters 'bd' on the left and '9.6' on the right, with a 'k' below it.</p>	<p>Current baud rate (stay 2s)</p>
<p>The LCD display shows the Greek letter Σ on the left and '00008.96' in the center, with 'kWh' below it.</p>	<p>Total active energy(kWh) Total=Import+ Export Max read: 999999.9 kWh</p>



### Buttons function

There are two buttons on the front panel.



	<ul style="list-style-type: none"> <li>&gt;Scroll the display for data checking.</li> <li>&gt;Changing option at Set-up mode</li> <li>&gt;Exit the Set-up mode</li> </ul>
	<ul style="list-style-type: none"> <li>&gt;Set-up mode entry</li> <li>&gt;Confirmation</li> </ul>

**Scroll display**

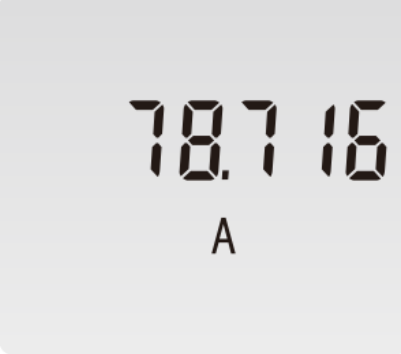

After initialization and self-checking program, the meter displays the measured values. The default page is total kWh. If the user wants to check other information, please press the scroll button  on the front panel.

	<p>Total active energy(kWh)                  Total=Import+ Export                  Display format:                  5+2 -&gt; 6+1 -&gt; 5+2                  99999.99 -&gt; 100000.0 -&gt;                  999999.9 -&gt; 00000.00</p>
	<p>Partial resettable active energy                  Display format:                  5+2 -&gt; 6+1 -&gt; 5+2                  99999.99 -&gt; 100000.0 -&gt;                  999999.9 -&gt; 00000.00</p>
	<p>T1~T4: total kWh                  *Multi-tariff version only</p>





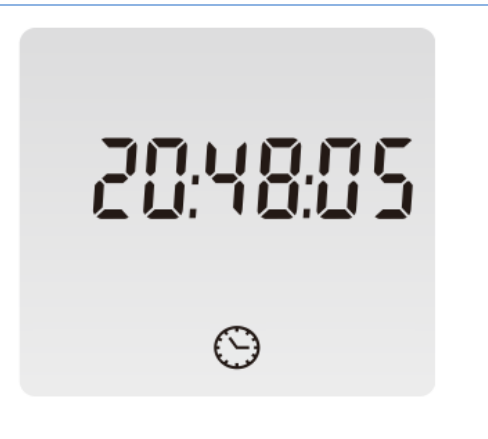













 <p style="text-align: center;">680.9 V</p>	<p>Voltage</p>
 <p style="text-align: center;">78.7 16 A</p>	<p>Current</p>
 <p style="text-align: center;">38.468 kW</p>	<p>Power</p> <p>Display format:</p> <p>&lt;1000 W: XXX W</p> <p>&lt;1000kW: XXX.XXX kW</p> <p>For other value: XXXX.XX kW</p>
 <p style="text-align: center;">[ 1000</p>	<p>Pulse constant</p>

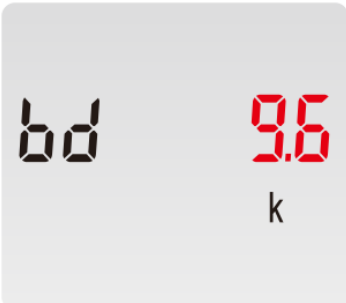

















<p>The LCD display shows the text 'ct 1: 1000' in a seven-segment font. 'ct' is on the left, followed by a colon and a space, and '1000' is on the right.</p>	<p>CT1 Primary current</p>
<p>The LCD display shows the text 'Add 001' in a seven-segment font. 'Add' is on the left, followed by a space, and '001' is on the right.</p>	<p>Meter address</p>
<p>The LCD display shows the text 'bd 19.2 k' in a seven-segment font. 'bd' is on the left, followed by a space, '19.2' is in the middle, and 'k' is on the right below the decimal point.</p>	<p>Baud rate</p>
<p>The LCD display shows the text 'PRLY n' in a seven-segment font. 'PRLY' is on the left, followed by a space, and 'n' is on the right.</p>	<p>Parity</p>











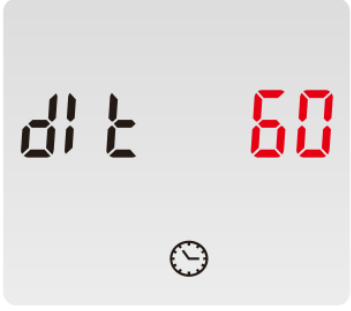







	<p>Date</p> <p>*Multi-tariff version only</p>
	<p>Time</p> <p>*Multi-tariff version only</p>
	<p>Software Version</p>













Set-up Mode

To get into Set-up Mode, the user need press the “Enter” button  for 3 second.





Page	Display	Descriptions
1		<p><b>Password</b></p> <p>To get into Set-up mode, it asks a password confirmation. Default password: 1000</p> <p>Use  and  to enter correct password.</p>
2		<p>Keep pressing  for 3 second, the current selection will flash, use  and  to change the Modbus address. Options: 1~247</p> <p>Keep press  for 3s to confirm the selection.</p>
3		<p>Keep pressing  for 3 second, the current selection will flash, use  and  to change the Baud rate. Options: 1.2k, 2.4k,4.8k,9.6k ( default ),19.2k</p> <p>Keep press  for 3s to confirm the selection.</p>
4		<p>Keep pressing  for 3 second, the current selection will flash, use  and  to change the Parity. Options: EVEN,ODD,NONE ( default )</p>

<p>5</p>		<p>Keep pressing  for 3 second, the current selection will flash, use  and  to change the type of Pulse Output.</p> <p>Options: total kWh, IMP kWh, EXP kWh</p>
<p>6</p>		<p>Keep pressing  for 3 second, the current selection will flash, use  and  to change the pulse constant.</p> <p>Options: 1000, 100, 10, 1 imp/kWh</p> <p>*Default pulse constant is related to the CT1 setting</p>
<p>7</p>		<p>Keep pressing  for 3 second, the current selection will flash, use  and  to change the pulse width.</p> <p>Options: 60, 100, 200, unit: ms</p>
<p>8</p>		<p>Use  to select the CT1 option. Keep pressing  for 3 second, the current selection will flash, use  and  to enter the Primary current. The range is from 0001 to 2000. For example, if using a 100A/75mV current transformer, the CT1 shall be 0100.</p> <p>Keep press  for 3s to confirm the selection.</p> <p>Deafult : 1A</p>

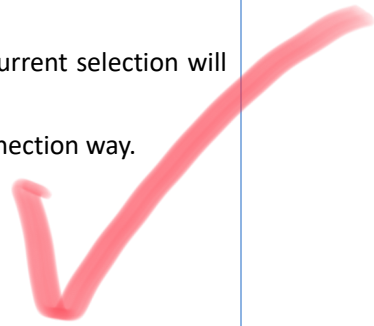
9		<p>Keep pressing  for 3 second, the current selection will flash, use  and  to change the DIT(Demand Integration Time).</p> <p>Options: 0,5,8,10,15,20,30,60( default)</p>
10		<p>Use  to select the scroll display time option. Keep pressing  for 3 second, the current selection will flash, use  and  to enter the options: 0~60s.</p> <p>Default: 0 s, represent do not scroll display</p>
11		<p>Use  to select the backlit time option. Keep pressing  for 3 second, the current selection will flash, use  and  to enter the options: 0,5,10,20,30,60 minutes. 0 means the light is always on.</p> <p>Default: 60 minutes</p>
12		<p>Use  to select the Password option. Keep pressing  for 3 second, the current selection will flash, use  and  to enter the new password. The range is from 0001 to 9999.</p> <p>Default: 1000</p>

<p>13</p>		<p>Shunt wiring</p> <p>Use  to select the shunt connection option. Keep pressing  for 3 second, the current selection will flash, use  to choose the connection way.</p> <p>Option: N, P</p> <p>N: Negative type (default)</p> <p>P: Positive type</p>
<p>14</p>		<p>Use  to select the date interface, Keep pressing  for 3 second.</p> <p>*Multi-tariff version only</p>
<p>14-1</p>		<p>the current selection will flash, use  and  to set the correct date information.</p> <p>*Multi-tariff version only</p>
<p>15</p>		<p>Use  to select the time interface, Keep pressing  for 3 second.</p> <p>*Multi-tariff version only</p>



15-1		<p>the current selection will flash, use  and  to set the correct time information</p> <p>*Multi-tariff version only</p>
16		<p>Tariff information ( for view only and cannot be set)</p> <p>*Multi-tariff version only</p>
16-1		<p>T1 means tariff number</p> <p>Range from T1-T4</p> <p>T0 means invalid rate number.</p> <p>01 means serial number.</p> <p>Range: 01-08</p> <p>18:00 mean the starting time of current tariff number.</p>

Keep pressing button  to exit the set-up mold.



Wiring diagram

Terminal Connection

AC Power Supply:

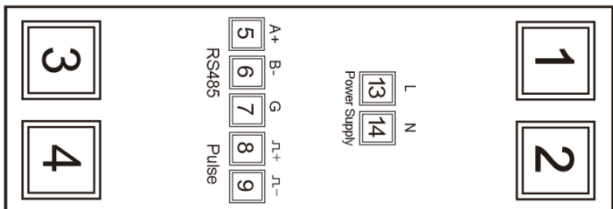

DC Power Supply:

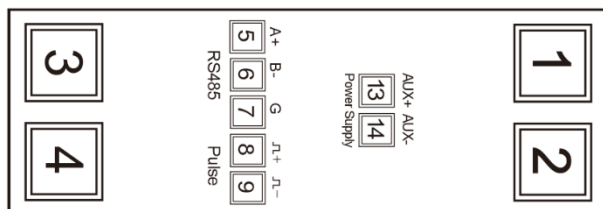

Shunt Connection

Positive Type:

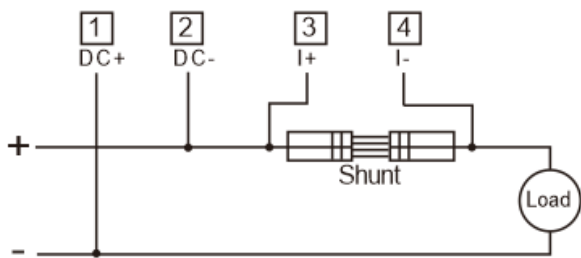

Negative Type:

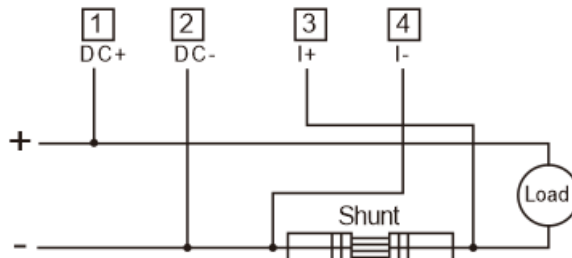

Dimensions

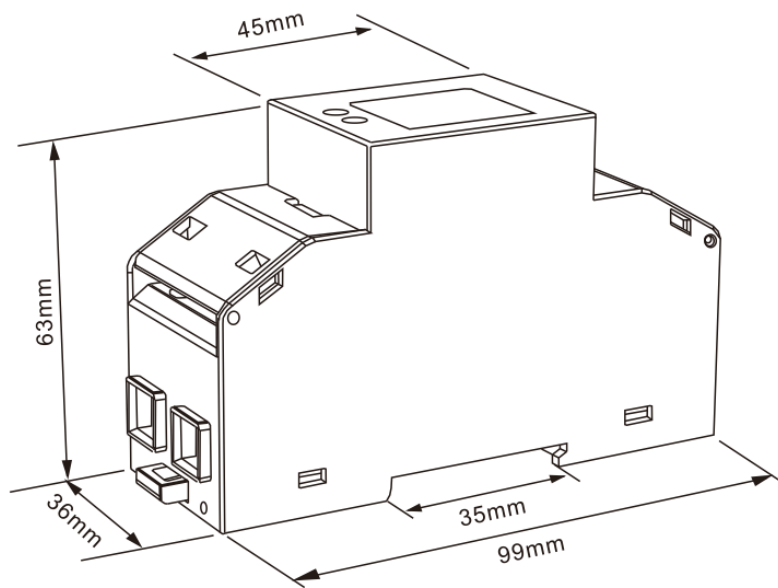



34877	Total active Energy Rate 1	4	Float	kWh	13	0C
34879	Total active Energy Rate 2	4	Float	kWh	13	0E
34881	Total active Energy Rate 3	4	Float	kWh	13	10
34883	Total active Energy Rate 4	4	Float	kWh	13	12
34885	Import active Energy Rate 1	4	Float	kWh	13	14
34887	Import active Energy Rate 2	4	Float	kWh	13	16
34889	Import active Energy Rate3	4	Float	kWh	13	18
34891	Import active Energy Rate 4	4	Float	kWh	13	1A
34893	Export active Energy Rate 1	4	Float	kWh	13	1C
34895	Export active Energy Rate 2	4	Float	kWh	13	1E
34897	Export active Energy Rate 3	4	Float	kWh	13	20
34899	Export active Energy Rate 4	4	Float	kWh	13	22
38193	Total Last 1 month active Energy (Total、Rate1、Rate2、Rate3、Rate4)	20	Float	kWh	20	00
38203	Total Last 2 month active Energy (Total、Rate1、Rate2、Rate3、Rate4)	20	Float	kWh	20	0A
38213	Total Last 3 month active Energy (Total、Rate1、Rate2、Rate3、Rate4)	20	Float	kWh	20	14
38223	Total Last4 month active Energy (Total、Rate1、Rate2、Rate3、Rate4)	20	Float	kWh	20	1E
38233	Total Last 5 month active Energy (Total、Rate1、Rate2、Rate3、Rate4)	20	Float	kWh	20	28
38243	Total Last 6 month active Energy (Total、Rate1、Rate2、Rate3、Rate4)	20	Float	kWh	20	32
38253	Total Last 7 month active Energy (Total、Rate1、Rate2、Rate3、Rate4)	20	Float	kWh	20	3C
38263	Total Last 8 month active Energy	20	Float	kWh		46

	(Total、Rate1、Rate2、Rate3、Rate4)				20	
38273	Total Last 9month active Energy (Total、Rate1、Rate2、Rate3、Rate4)	20	Float	kWh	20	50
38283	Total Last 10 month active Energy (Total、Rate1、Rate2、Rate3、Rate4)	20	Float	kWh	20	5A
38293	Total Last 11 month active Energy (Total、Rate1、Rate2、Rate3、Rate4)	20	Float	kWh	20	64
38303	Total Last 12 month active Energy (Total、Rate1、Rate2、Rate3、Rate4)	20	Float	kWh	20	6E
312289	Total Last 1 day active Energy	4	Float	kWh	30	00
312291	Total Last 2 days active Energy	4	Float	kWh	30	02
312293	Total Last 3 days active Energy	4	Float	kWh	30	04
312295	Total Last 4 days active Energy	4	Float	kWh	30	06
312297	Total Last 5 days active Energy	4	Float	kWh	30	08
312299	Total Last 6 days active Energy	4	Float	kWh	30	0A
312301	Total Last 7 days active Energy	4	Float	kWh	30	0C
312303	Total Last 8 days active Energy	4	Float	kWh	30	0E
312305	Total Last 9 days active Energy	4	Float	kWh	30	10
312307	Total Last 10 days active Energy	4	Float	kWh	30	12
312309	Total Last 11 days active Energy	4	Float	kWh	30	14
312311	Total Last 12 days active Energy	4	Float	kWh	30	16
312313	Total Last 13 days active Energy	4	Float	kWh	30	18
312315	Total Last 14 days active Energy	4	Float	kWh	30	1A
312317	Total Last 15 days active Energy	4	Float	kWh	30	1C
312319	Total Last 16 days active Energy	4	Float	kWh	30	1E
312321	Total Last 17 days active Energy	4	Float	kWh	30	20
312323	Total Last 18 days active Energy	4	Float	kWh	30	22

312325	Total Last 19 days active Energy	4	Float	kWh	30	24
312327	Total Last 20 days active Energy	4	Float	kWh	30	26
312329	Total Last 21 days active Energy	4	Float	kWh	30	28
312331	Total Last 22 days active Energy	4	Float	kWh	30	2A
312333	Total Last 23 days active Energy	4	Float	kWh	30	2C
312335	Total Last 24 days active Energy	4	Float	kWh	30	2E
312337	Total Last 25 days active Energy	4	Float	kWh	30	30
312339	Total Last 26 days active Energy	4	Float	kWh	30	32
312341	Total Last 27 days active Energy	4	Float	kWh	30	34
312343	Total Last 28 days active Energy	4	Float	kWh	30	36
312345	Total Last 29 days active Energy	4	Float	kWh	30	38
312347	Total Last 30 days active Energy	4	Float	kWh	30	3A
30385	Current resettable total active energy	4	Float	kWh	01	80
316385	Line to neutral volts.	4	Float	V	40	00
316387	Current.	4	Float	A	40	02
316389	Active power.	4	Float	W	40	04
316391	Import active energy	4	Float	W	40	06
316393	Emport active energy	4	Float	W	40	08
316395	Total system power demand	4	Float	kWh	40	0A
316397	Maximum total system power demand	4	Float	kWh	40	0C
316399	Total active energy	4	Float	kWh	40	0E
316401	Current resettable total active energy	4	Float	kWh	40	10
316403	Current overload alarm  00 00 means no alarm  00 01 means Current overload alarm	2	Hex	None	40	12

Note:

(1): The method of power demand calculation is: Import- Export. When the import and export powers appear in the demand period, the import power subtract the export power during data processing.

(2) The red marked are commonly used registers which allow users to read continuously at one time.

(3) The green marked registers are used for Multi-tariff version only

### Holding Registers

Holding registers are used to store and display instrument configuration settings. All holding registers not listed in the table below should be considered as reserved for manufacturer use and no attempt should be made to modify their values.

The holding register parameters may be viewed or changed using the Modbus Protocol. Each parameter is held in two consecutive 4X registers. Modbus Protocol Function Code 03 is used to read the parameter and Function Code 10 is used to write. Write to only one parameter per message.

Address Register	Parameter	Modbus Protocol Start Address Hex		Valid range	Mode
		High Byte	Low Byte		
40003	Demand Period	00	02	Write demand period: 0~60 minutes, default 60. Setting the period to 0 will cause the demand to show the current parameter value, and demand max to show the maximum parameter value since last demand reset. <b>Length : 4 byte</b> <b>Data Format : Float</b>	r/w
40005	Slide time	00	04	Default 1, min. Range : 1 ~ (Demand Period -1). <b>Length : 4 byte</b> <b>Data Format : Float</b>	r/w

40013	Pulse Width	00	0C	Write pulse1 on period in Milliseconds: 60, 100 or 200, default 100. Length : 4 byte Data Format: float	r/w
40019	Network Parity and Stop	00	12	Write the network port parity/stop bits for MODBUS Protocol, where: 0 = 1 stop bit and none parity, default. 1 = 1 stop bit and even parity. 2 = 1 stop bit and odd parity. 3 = 2 stop bit and none parity. Requires a restart to become effective.  <b>Length : 4 byte</b> <b>Data Format : Float</b>	r/w
40021	Modbus address	00	14	Write the Modbus address Address: 1 to 247 for MODBUS Protocol, default 1. Requires a restart to become effective.  <b>Length : 4 byte</b> <b>Data Format : Float</b>	r/w
40023	Pulse constant	00	16	Options: 0 means 1000 imp/kWh 1 means 100 imp/kWh 2 means 10 imp/kWh 3 means 1 imp/kWh  <b>Length : 4 byte</b> <b>Data Format: float</b>	r/w
40025	Password	00	18	Write password for access to protected registers.  <b>Length : 4 byte</b> <b>Data Format : Float</b>	ro



40029	Baud Rate	00	1C	Options: 0 means 2400 bps 1 means 4800 bps 2 means 9600 bps 3 means 19200 bps 5 means 1200 bps Default: 2 <b>Length : 4 byte</b> <b>Data Format: float</b>	r/w
40059	Auto-scroll display time	00	3A	Range: 0~60s. 0 means no scroll Default:0 <b>Length : 4 byte</b> <b>Data Format : Float</b>	r/w
40061	Backlit time	00	3C	Options:0~120 minutes 0 means the backlit always on Default: 60 <b>Length : 4byte</b> <b>Data Format : Float</b>	r/w
40087	Pulse output type	00	56	Options: 1 means Import active energy 2 means total active energy 4 means Export active energy Default: 2 <b>Length : 4 byte</b> <b>Data Format: float</b>	r/w
48193	Connection method of shunt	20	00	Setting on shunt connection. Option: 00 4E means Negative type (default) 00 50 means Positive type <b>Length: 2 byte</b> <b>Data Format: Hex</b>	r/w
461457	Reset	F0	10	00 00: Reset Maximum Demand 00 03: Reset Partial Energy <b>Length : 2 byte</b> <b>Data Format:Hex</b>	wo

463776	Energy Measurement model	F9	20	Options: 00 01: Total=Import 00 02: Total=Import+Export 00 03: Total=Export <b>Length : 2 byte</b> <b>Data Format: Hex</b>	r/w
461441	Date and Time	F0	00	Data definition: Second- minute- hour-week-date-month-year-20 <b>Length: 8 byte</b> <b>Data Format: BCD</b>	r/w
463233	Tariff information	F7	00	Date definition: Tariff number-minute- hour Tariff setting range: 01,02,03,04; 00 means invalid tariff rate Minute setting range: 00-59 Hour setting range: 00-23 <b>Length: 24 byte</b> <b>Data Format: BCD</b>	r/w
464513	Serial number	FC	00	<b>Serial number</b> <b>Length: 4 byte</b> <b>Data Format: unsigned int32</b> <b>Note: Only read</b>	ro

\* The green marked registers are used for Multi-tariff version only

## PART 4 Shunt



ESFL-2A Series

Primary Input	Rated Voltage Output	Accuracy	Dimension(mm)
10-50 A	75/60/45 mV	0.5%	25x120x22
75-100 A	75/60/45 mV	0.5%	23x109x11
150-200 A	75/60/45 mV	0.5%	22x118x22
300 A	75/60/45 mV	0.5%	26x127x22
400 A	75/60/45 mV	0.5%	36x127x22
500 A	75/60/45 mV	0.5%	46x127x22
600 A	75/60/45 mV	0.5%	55x127x22
750 A	75/60/45 mV	0.5%	76x127x22
1000 A	75/60/45 mV	0.5%	96x127x22
1500 A	75/60/45 mV	0.5%	113x127x22 or 87x200x97
2000 A	75/60/45 mV	0.5%	136x200x97