

Schematic	ESP32 Valve/Cover Controller			Update Date	2024-01-25
				Create Date	2024-01-15
Page	MCU			Part Number	
Drawn	ESP32 Valve/Cover Controller				
Reviewed					
	VER	SIZE	PAGE	1	OF 3
	Rev. 1	A4			

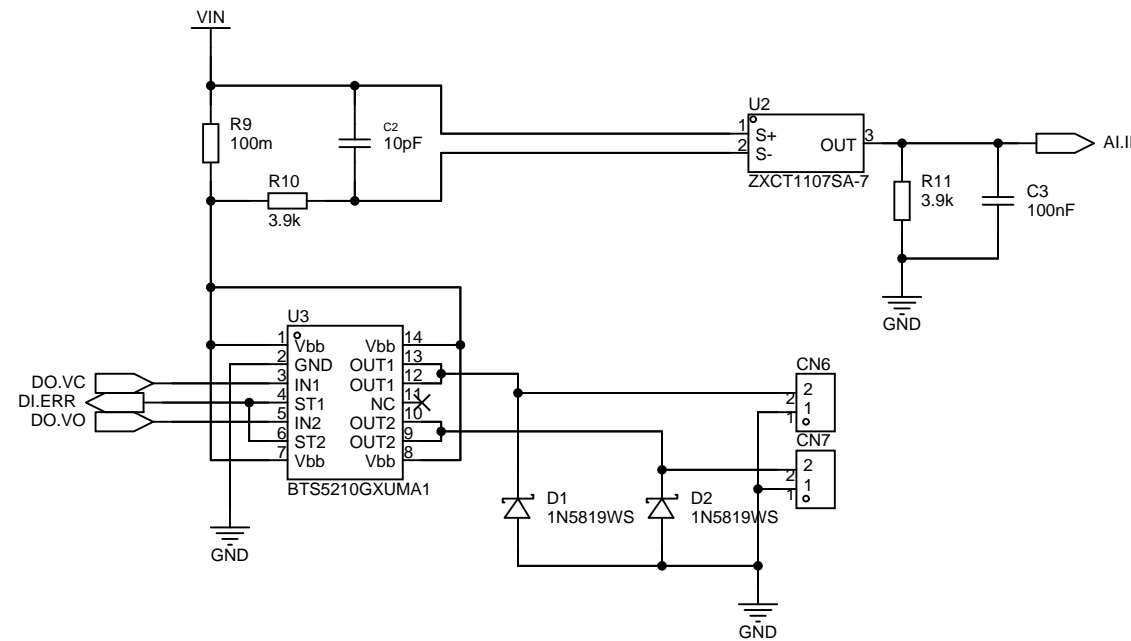

Schematic	ESP32 Valve/Cover Controller		Update Date	2024-01-25			
			Create Date	2024-01-15			
Page	Valve		Part Number				
Drawn			ESP32 Valve/Cover Controller				
Reviewed							
		VER	SIZE	PAGE	2	OF	3
		Rev. 1	A4				

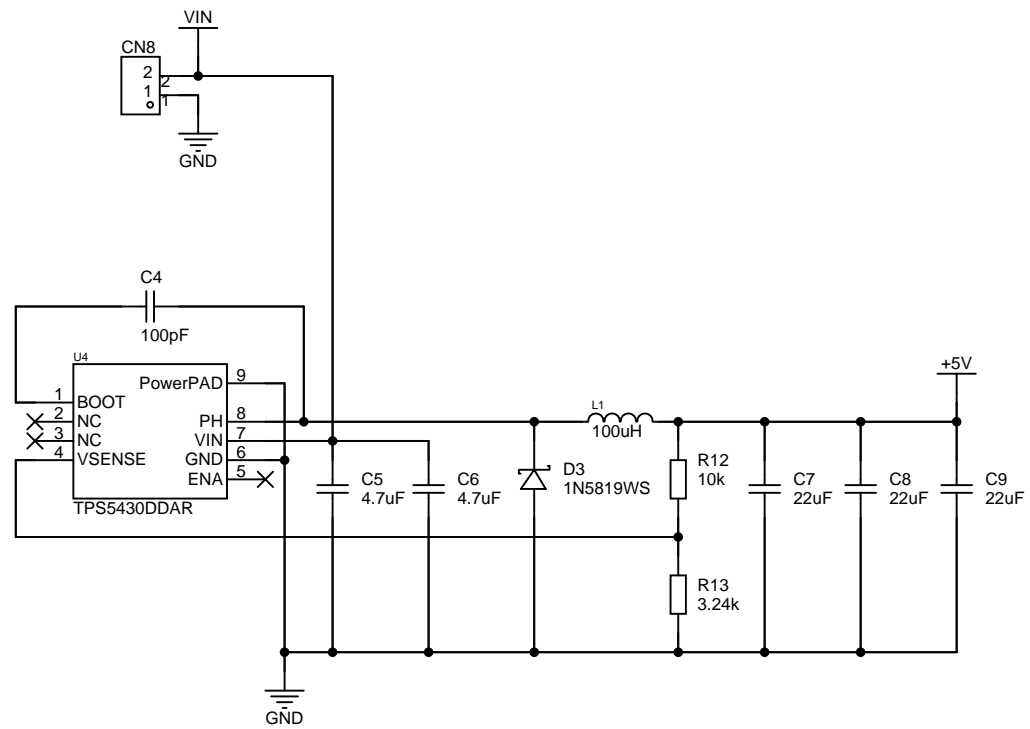

Schematic	ESP32 Valve/Cover Controller		Update Date	2024-01-25
			Create Date	2024-01-16
Page	Power Supply		Part Number	
Drawn		ESP32 Valve/Cover Controller		
Reviewed				
		VER	SIZE	PAGE 3 OF 3
		Rev. 1	A4	