

Product Overview

The SBB5089Z is a high performance InGaP HBT MMIC amplifier utilizing a Darlington configuration with an active bias circuitry. The active bias circuitry provides stable current over temperature and process variations. The SBB5089Z designed to run directly from a 5V supply, does not require a dropping resistor as compared to typical Darlington amplifiers. The SBB5089Z is a high linearity gain block for applications that require small in size with minimal number of external components. It is internally matched to 50 Ω at input and output.



3 Pin SOT-89 Package

Key Features

- 50 MHz – 6000 MHz
- ± 1.1 dB Wideband Flat Gain up to 4000 MHz
- +20.4 dBm P1dB at 1950 MHz
- +5 V Single Fixed Supply
- 1000V, HBM Class 1C Robust ESD
- Patented Thermal Design and Bias Circuitry
- Low Thermal Resistance

Functional Block Diagram

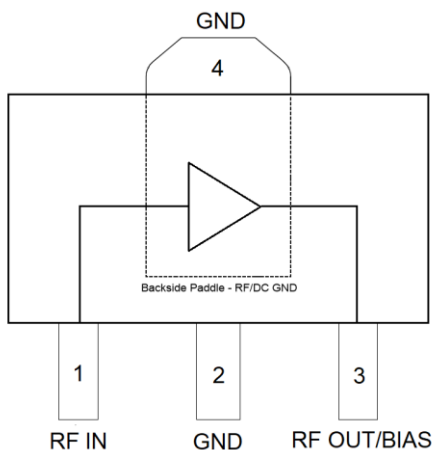

Top View

Applications

- PA Driver Amplifier
- Cellular, PCS, GSM, UMTS
- Wideband Instrumentation
- Wireless Data, Satellite Terminals

Ordering Information

Part No.	Description
SBB5089Z	1,000 pieces on a 7" reel (standard)
SBB5089Z PCK1	500–3500 MHz Evaluation Board with a 5-piece sample bag

Absolute Maximum Ratings

Parameter	Rating
Storage Temperature	-55 to +150 °C
RF Input Power, CW, 50 Ω, T=25 °C	+24 dBm
Device Voltage (V _C)	+5.5 V
Device Current (I _C)	100 mA
Dissipated Power (P _{DISS})	0.55 W
Junction Temperature (T _J)	+150 °C

Exceeding any one or a combination of the Absolute Maximum Rating conditions may cause permanent damage to the device. Extended application of Absolute Maximum Rating conditions to the device may reduce device reliability.

Electrical Specifications

Parameter	Conditions ⁽¹⁾	Min	Typ	Max	Units
Operational Frequency Range		50		6000	MHz
Gain, Small Signal	850 MHz	19.0	20.5	22.0	dB
	1950 MHz	18.3	19.0	21.5	dB
	6000 MHz	14.5	15.5	17.5	dB
Input Return Loss	1950 MHz	10	13		dB
Output Return Loss		10	14		dB
Output P1dB	850 MHz		20.5		dBm
	1950 MHz	19.0	20.0		dBm
Output IP3 ⁽²⁾	850 MHz		38.5		dBm
	1950 MHz	33.0	35.0		dBm
Bandwidth	Minimum 10 dB typical return loss		3000		MHz
Reverse Isolation	1950 MHz		23.3		dB
Noise Figure			3.9	4.9	dB
Device Operating Current, I _C	Pin 3	60	75	92	mA
Thermal Resistance, θ _{JC}	Junction to case		69.9		°C/W

Notes:

1. Test conditions unless otherwise noted: V_C = +5.0 V, I_C = 75 mA, Temp = +25 °C, 50 Ω test system, Tested with Bias Tees
2. P_{OUT} = 0 dBm/tone, Δf = 1 MHz

Recommended Operating Conditions

Parameter	Min	Typ	Max	Units
Device Voltage (V _C)	+4.75	+5	+5.25	V
T _{CASE}	-55		+105	°C

Electrical specifications are measured at specified test conditions. Specifications are not guaranteed over all recommended operating conditions.

500 – 3500 MHz Evaluation Board – SBB5089ZPCK1

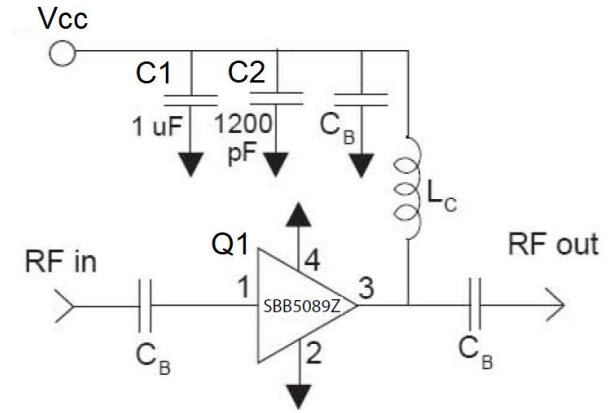
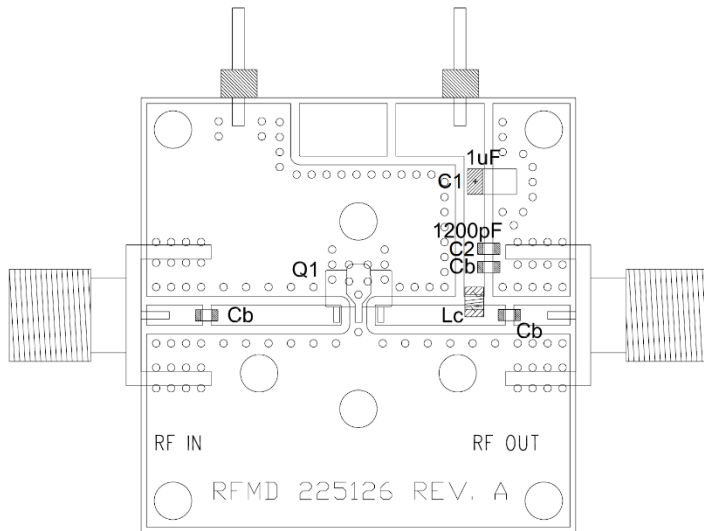

Bill of Material – SBB5089ZPCK1

Reference Des.	Value	Description	Manuf.	Part Number
PCB	-	Printed Circuit Board	Qorvo	
Q1	-	SBB5089Z Amplifier, SOT-89 pkg.	Qorvo	SBB5089Z
C1	1 μ F	CAP, 1 μ F, 20%, 20V, TANT, 1206	various	
C2	1200 pF	CAP, 1200 pF, 10%, 50V, X7R, 0603	various	
C _B	68 pF	CAP, 68 pF, 5%, 50V. NPO/COG, 0603	various	
L _C	82 nH	IND, 82 nH, 5%, W/W, 0805	Coilcraft	0805CS-330XJLB

Note for < 500 MHz: C_B 1.0 μ F, 10%, 160, X7R, 0603; L_C 330 nH, 5%, 0805

Typical Performance – SBB5089ZPCK1

Parameter ⁽¹⁾	Typical Value										Units
	50	100	200	500	850	1950	2500	3500	4000		
Frequency	50	100	200	500	850	1950	2500	3500	4000		MHz
Gain, Small Signal	21.1	20.9	20.8	20.8	20.8	20.1	19.8	18.7	17.8		dB
Input Return Loss	11.3	17.4	24.3	27.2	22.7	14.6	12.9	10.6	11.6		dB
Output Return Loss	15.9	21.7	30.4	31.8	21.5	13.5	12.0	13.5	27.5		dB
Reverse Isolation	17.4	17.5	17.5	22.7	22.8	23.4	23.7	24.7	25.7		dB
Output P1dB	19.4	19.7	20.0	20.5	20.4	20.4	19.4	16.9	14.7		dBm
OIP3 ⁽²⁾	36.0	37.8	37.5	38.6	39.2	34.9	32.8	29.4	26.8		dBm
Noise Figure	4.4	4.4	4.3	3.8	3.8	4.1	4.1	4.3	4.6		dB

Notes:

1. Test conditions unless otherwise noted: V_{CC} = +5V, I_C = 75 mA, 50 Ω test system, Temp. = +25 °C
2. P_{out} = 0 dBm/tone, Δ f = 1 MHz

Performance Plots – SBB5089ZPCK1

Test conditions unless otherwise noted: $V_{CC} = +5V$, $I_C = 75\text{ mA}$, $50\ \Omega$ test system, $Temp. = +25\ ^\circ C$

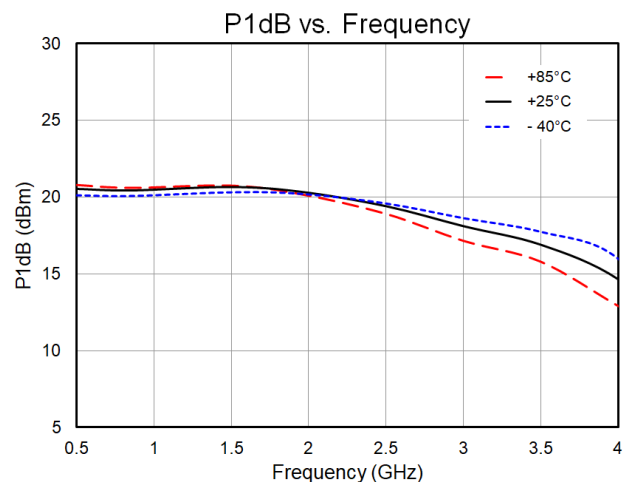
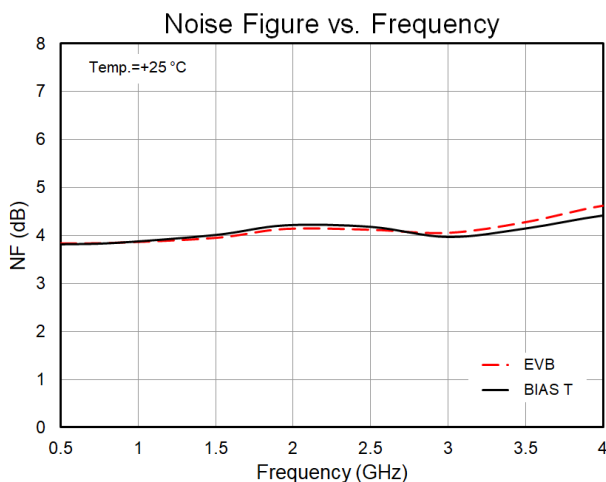
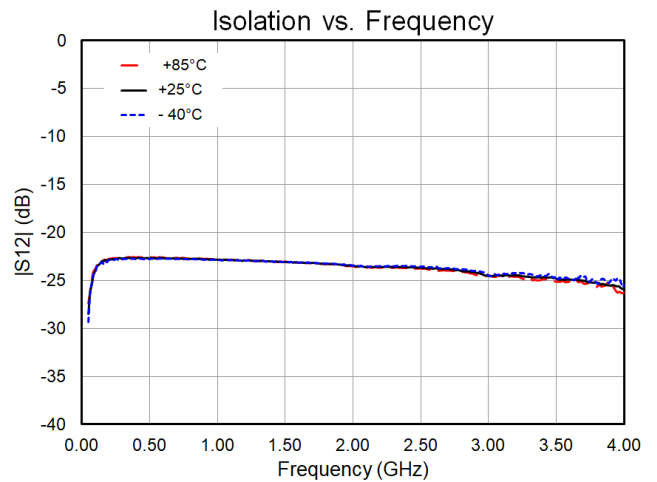
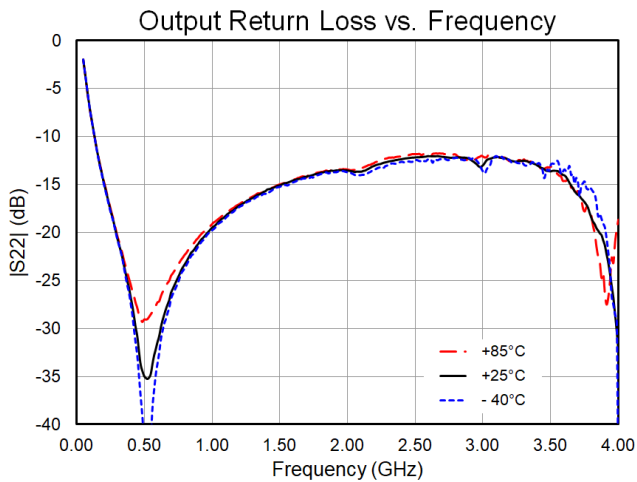
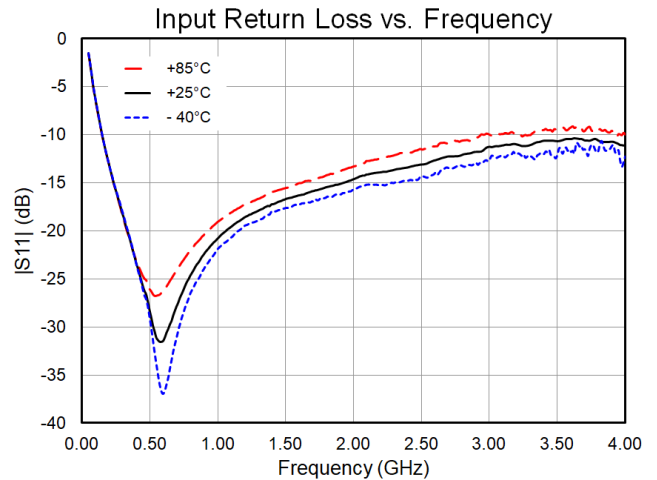
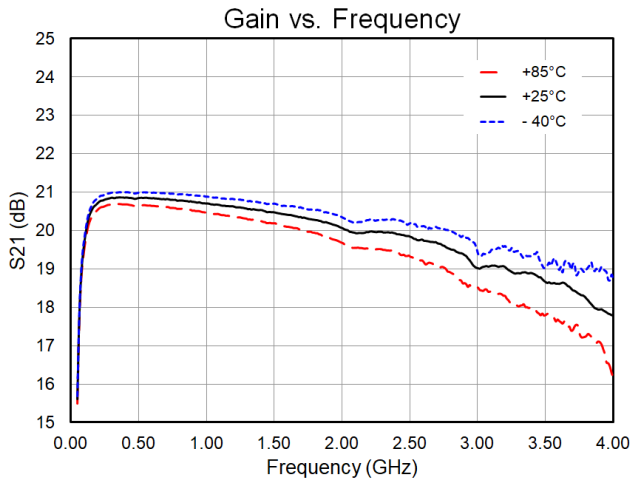

Performance Plots – SBB5089ZPCK1 (continued)

Test conditions unless otherwise noted: $V_{CC} = +5V$, $I_C = 75\text{ mA}$, $50\ \Omega$ test system, Temp. = $+25\ ^\circ\text{C}$

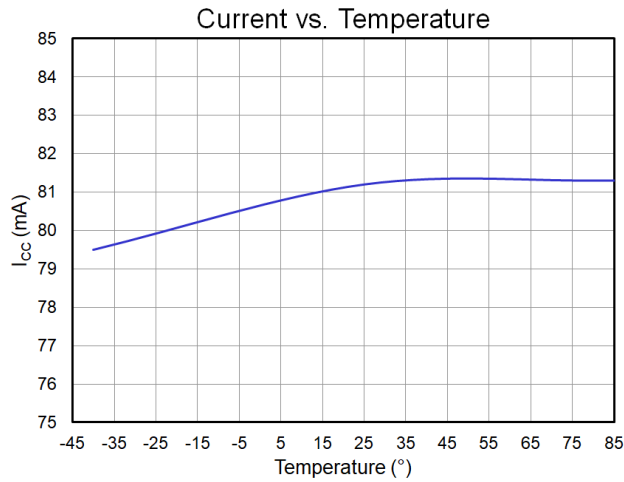
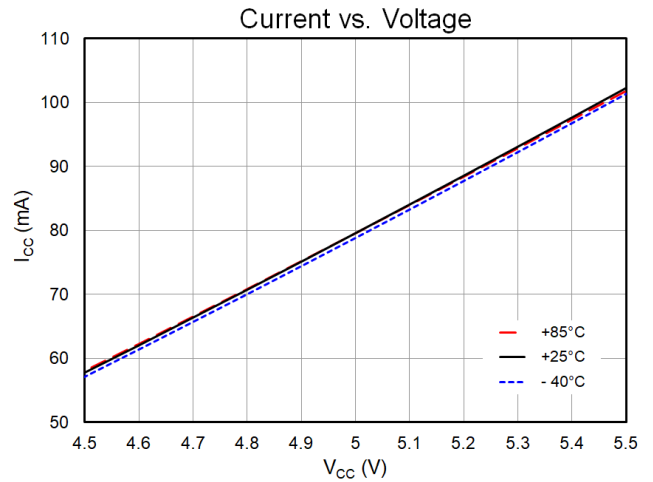
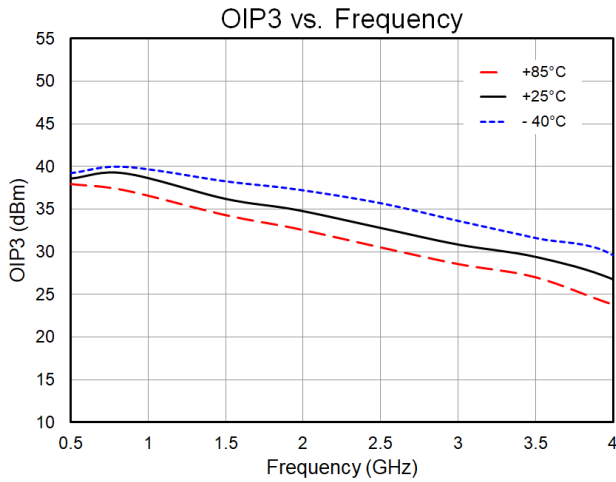

Performance Plots – with BIAS Tees

Test conditions unless otherwise noted: $V_C = +5V$, $I_C = 75\text{ mA}$, $50\ \Omega$ test system, Temp. = $+25\ ^\circ\text{C}$, with BIAS Tees

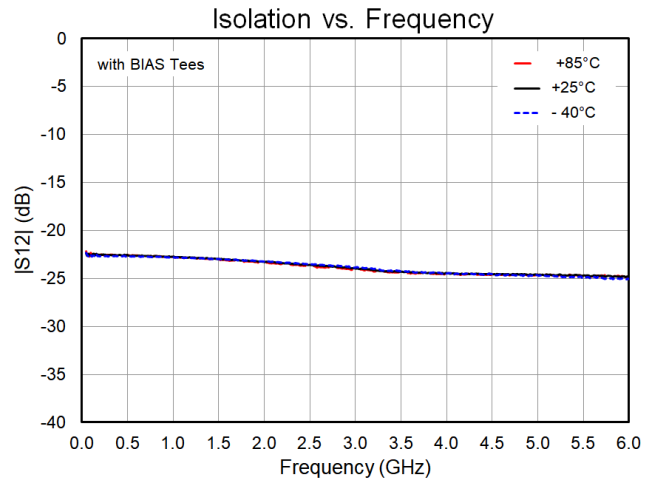
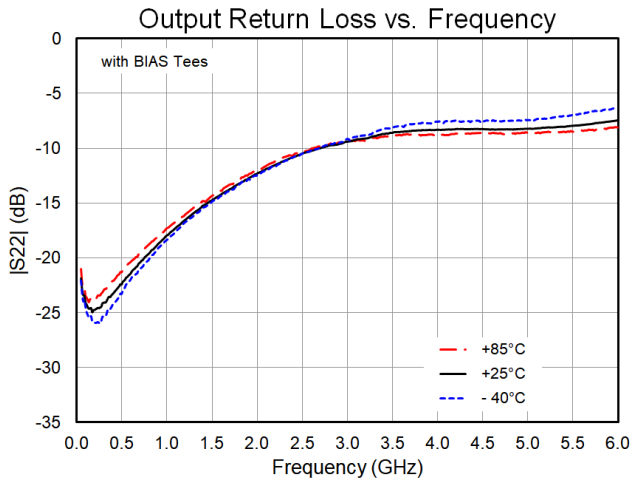
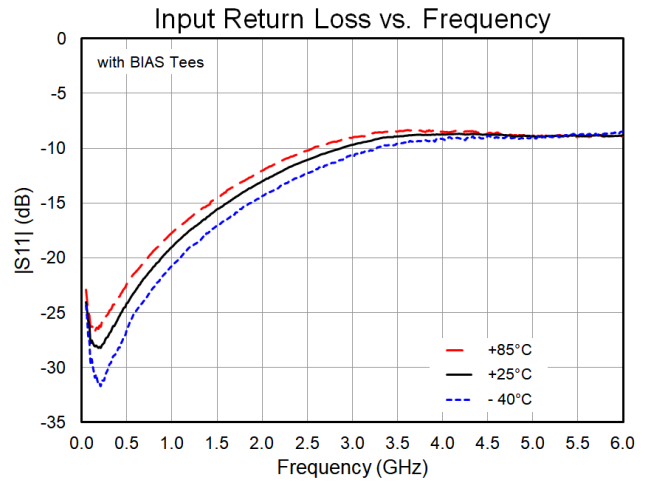
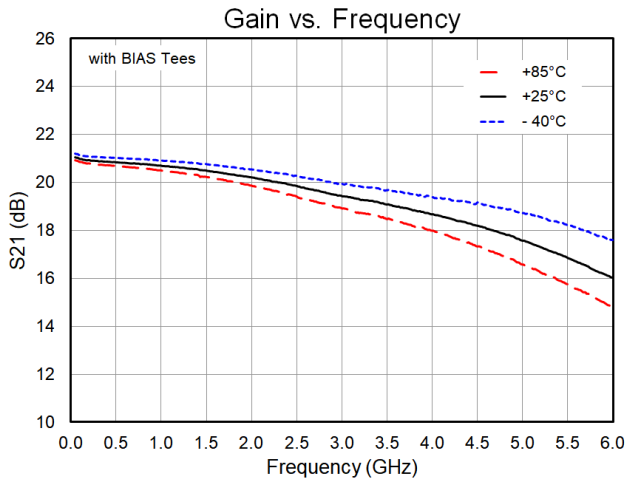

Pad Configuration and Description

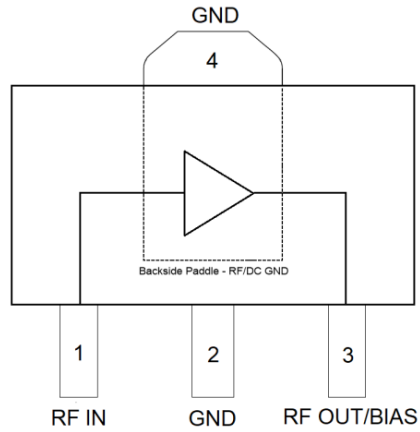

Top View

Pad No.	Label	Description
1	RF IN	RF input. External DC Block capacitor required.
3	RF OUT / BIAS	RF output and DC Supply input. External DC Block capacitor and bias voltage required.
2, 4 Backside Paddle	GND	RF/DC ground. Use recommended via hole pattern to minimize inductance and thermal resistance. See PCB Mounting Pattern for suggested footprint.

Package Marking and Dimensions

Marking: Part Number – SBB5089Z
Trace Code – Assigned by sub-contractor

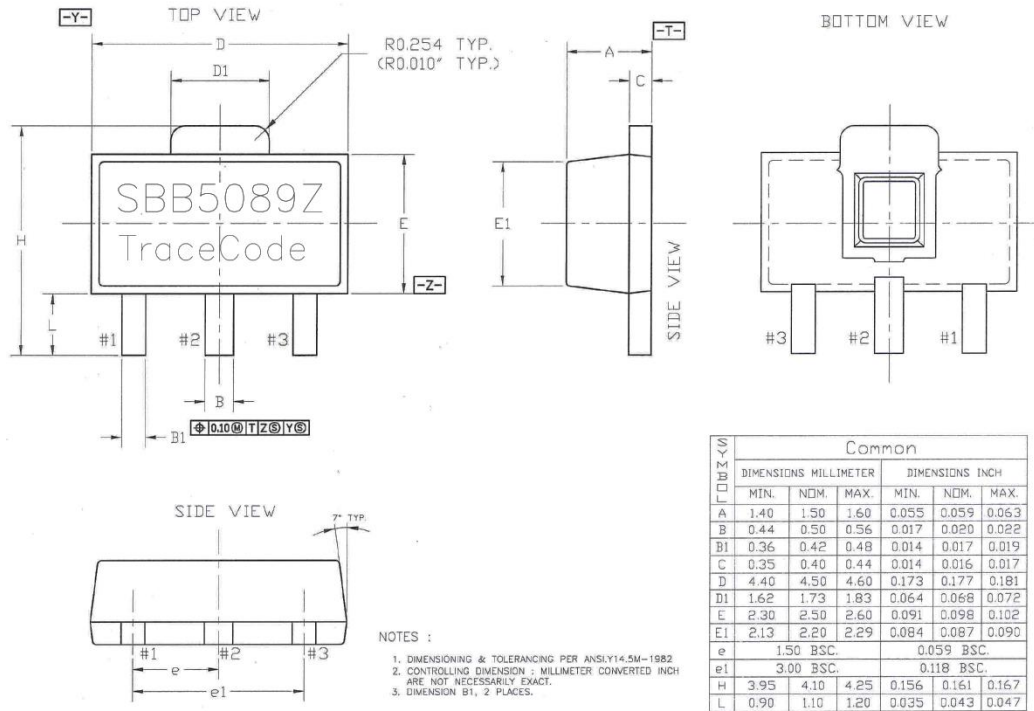

- Notes:
- All dimensions are in millimeters. Angles are in degrees.
 - The terminal #1 identifier and terminal numbering conform to JESD 95-1 SPP-012.

PCB Mounting Pattern

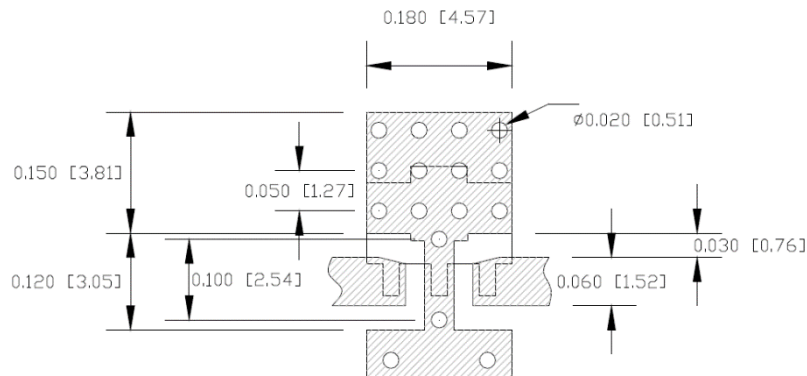

- Notes:
- All dimensions are in millimeters. Angles are in degrees.
 - Use 1 oz. copper minimum for top and bottom layer metal.
 - Via holes are required under the backside paddle of this device for proper RF/DC grounding and thermal dissipation. We recommend a 0.35mm (#80/.0135") diameter bit for drilling via holes and a final plated thru diameter of 0.25 mm (0.01").
 - Ensure good package backside paddle solder attach for reliable operation and best electrical performance.

Tape and Reel Information – Carrier and Cover Tape Dimensions

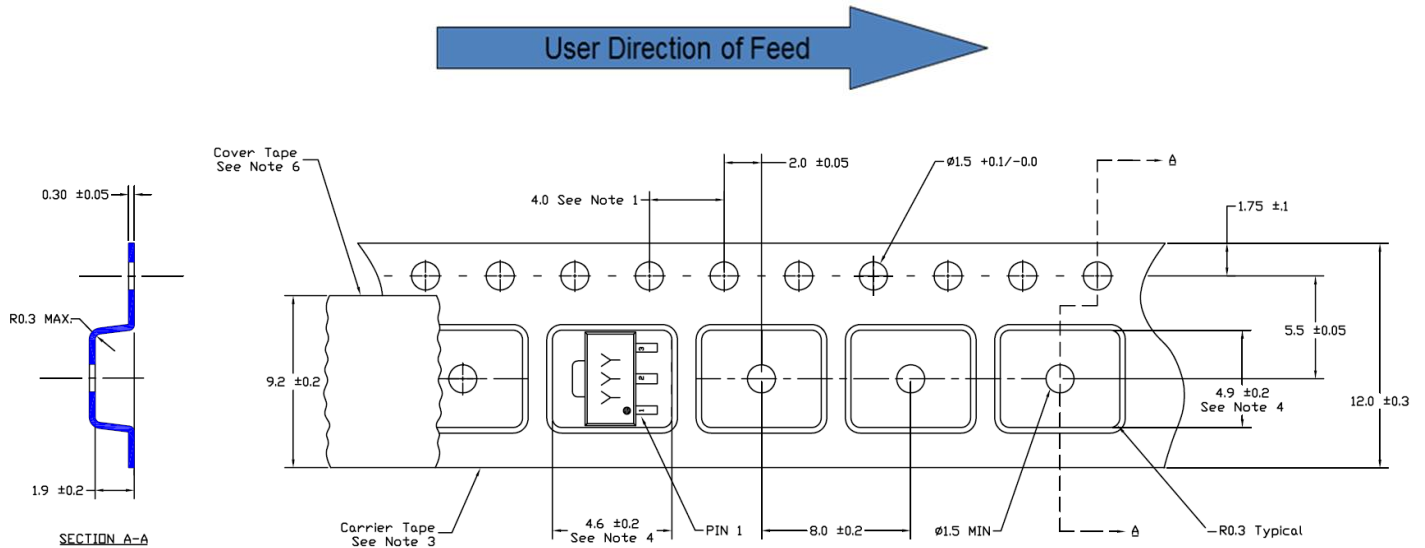

1. 10 sprocket hole pitch cumulative tolerance
2. Camber not to exceed 1mm in 100mm
3. Material: Black Conductive Polystyrene
4. Measured on a plane 0.3mm above the bottom of the pocket
5. Measured from a plane on the inside bottom of the pocket to the top surface of the carrier.
6. Material: Antistatic Polyester Film

Feature	Measure	Symbol	Size (in)	Size (mm)
Cavity	Length	A0	0.181	4.60
	Width	B0	0.193	4.90
	Depth	K0	0.075	1.90
	Pitch	P1	0.315	8.00
Centerline Distance	Cavity to Perforation - Length Direction	P2	0.079	2.00
	Cavity to Perforation - Width Direction	F	0.217	5.50
Cover Tape	Width	C	0.362	9.20
Carrier Tape	Width	W	0.472	12.0

Tape and Reel Information – Reel Dimensions

Standard T/R size = 1,000 pieces on a 7" reel.

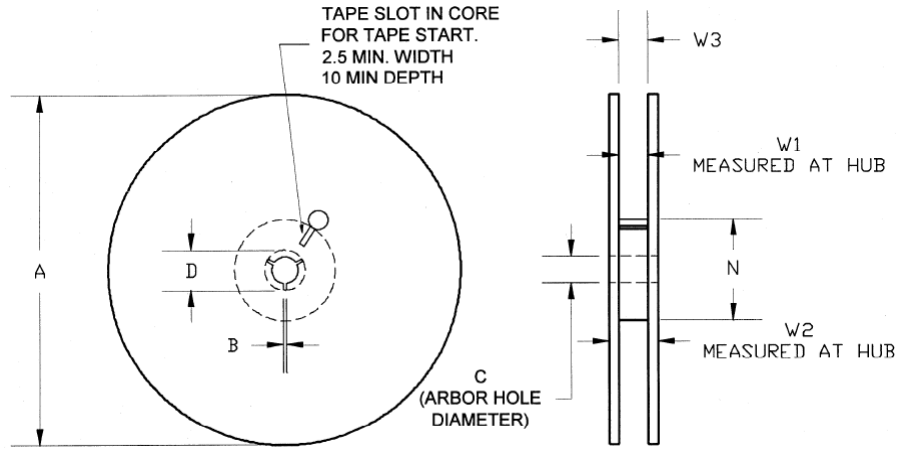

Feature	Measure	Symbol	Size (in)	Size (mm)
Flange	Diameter	A	6.969	177.0
	Thickness	W2	0.717	18.2
	Space Between Flange	W1	0.504	12.8
Hub	Outer Diameter	N	2.283	58.0
	Arbor Hole Diameter	C	0.512	13.0
	Key Slit Width	B	0.079	2.0
	Key Slit Diameter	D	0.787	20.0

Tape and Reel Information – Tape Length and Label Placement



- Notes:
1. Empty part cavities at the trailing and leading ends are sealed with cover tape. See EIA 481-1-A.
 2. Labels are placed on the flange opposite the sprockets in the carrier tape.

Handling Precautions

Parameter	Rating	Standard
ESD – Human Body Model (HBM)	Class 1C	ESDA / JEDEC JS-001-2012
MSL – Moisture Sensitivity Level	Level 3	IPC/JEDEC J-STD-020



Caution!
 ESD-Sensitive Device

Solderability

Compatible with both lead-free (260°C max. reflow temp.) and tin/lead (245°C max. reflow temp.) soldering processes. Solder profiles available upon request.

Contact plating: NiPdAu

RoHS Compliance

This part is compliant with 2011/65/EU RoHS directive (Restrictions on the Use of Certain Hazardous Substances in Electrical and Electronic Equipment) as amended by Directive 2015/863/EU.

This product also has the following attributes:

- Lead Free
- Halogen Free (Chlorine, Bromine)
- Antimony Free
- TBBP-A (C₁₅H₁₂Br₄O₂) Free
- PFOS Free
- SVHC Free



Contact Information

For the latest specifications, additional product information, worldwide sales and distribution locations:

Web: www.qorvo.com

Tel: 1-844-890-8163

Email: customer.support@qorvo.com

Important Notice

The information contained herein is believed to be reliable; however, Qorvo makes no warranties regarding the information contained herein and assumes no responsibility or liability whatsoever for the use of the information contained herein. All information contained herein is subject to change without notice. Customers should obtain and verify the latest relevant information before placing orders for Qorvo products. The information contained herein or any use of such information does not grant, explicitly or implicitly, to any party any patent rights, licenses, or any other intellectual property rights, whether with regard to such information itself or anything described by such information. **THIS INFORMATION DOES NOT CONSTITUTE A WARRANTY WITH RESPECT TO THE PRODUCTS DESCRIBED HEREIN, AND QORVO HEREBY DISCLAIMS ANY AND ALL WARRANTIES WITH RESPECT TO SUCH PRODUCTS WHETHER EXPRESS OR IMPLIED BY LAW, COURSE OF DEALING, COURSE OF PERFORMANCE, USAGE OF TRADE OR OTHERWISE, INCLUDING THE IMPLIED WARRANTIES OF MERCHANTABILITY AND FITNESS FOR A PARTICULAR PURPOSE.**

Without limiting the generality of the foregoing, Qorvo products are not warranted or authorized for use as critical components in medical, life-saving, or life-sustaining applications, or other applications where a failure would reasonably be expected to cause severe personal injury or death.

Copyright 2021 © Qorvo, Inc. | Qorvo is a registered trademark of Qorvo, Inc.

Mouser Electronics

Authorized Distributor

Click to View Pricing, Inventory, Delivery & Lifecycle Information:

Qorvo:

[SBB5089Z](#) [SBB5089ZSR](#)