

Intel® Desktop Board D845GVSR Product Guide

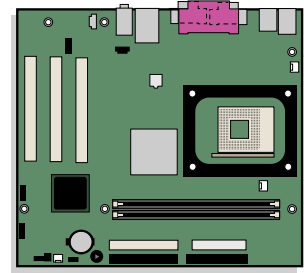

Order Number: C45520-001

Revision History

Revision	Revision History	Date
-001	First release of the Intel® Desktop Board D845GVSR Product Guide.	July 2003

If an FCC declaration of conformity marking is present on the board, the following statement applies:

FCC Declaration of Conformity

This device complies with Part 15 of the FCC Rules. Operation is subject to the following two conditions: (1) this device may not cause harmful interference, and (2) this device must accept any interference received, including interference that may cause undesired operation.

For questions related to the EMC performance of this product, contact:

Intel Corporation
5200 N.E. Elam Young Parkway
Hillsboro, OR 97124
1-800-628-8686

This equipment has been tested and found to comply with the limits for a Class B digital device, pursuant to Part 15 of the FCC Rules. These limits are designed to provide reasonable protection against harmful interference in a residential installation. This equipment generates, uses, and can radiate radio frequency energy and, if not installed and used in accordance with the instructions, may cause harmful interference to radio communications. However, there is no guarantee that interference will not occur in a particular installation. If this equipment does cause harmful interference to radio or television reception, which can be determined by turning the equipment off and on, the user is encouraged to try to correct the interference by one or more of the following measures:

- Reorient or relocate the receiving antenna.
- Increase the separation between the equipment and the receiver.
- Connect the equipment to an outlet on a circuit other than the one to which the receiver is connected.
- Consult the dealer or an experienced radio/TV technician for help.

Any changes or modifications to the equipment not expressly approved by Intel Corporation could void the user's authority to operate the equipment.

Canadian Department of Communications Compliance Statement

This digital apparatus does not exceed the Class B limits for radio noise emissions from digital apparatus set out in the Radio Interference Regulations of the Canadian Department of Communications.

Le présent appareil numérique n'émet pas de bruits radioélectriques dépassant les limites applicables aux appareils numériques de la classe B prescrites dans le Règlement sur le brouillage radioélectrique édicté par le ministère des Communications du Canada.

Disclaimer

Information in this document is provided in connection with Intel® products. No license, express or implied, by estoppel or otherwise, to any intellectual property rights is granted by this document. Except as provided in Intel's Terms and Conditions of Sale for such products, Intel assumes no liability whatsoever, and Intel disclaims any express or implied warranty, relating to sale and/or use of Intel products including liability or warranties relating to fitness for a particular purpose, merchantability, or infringement of any patent, copyright or other intellectual property right. Intel products are not intended for use in medical, life saving, or life sustaining applications. Intel may make changes to specifications and product descriptions at any time, without notice.

Desktop Board D845GVSR may contain design defects or errors known as errata which may cause the product to deviate from published specifications. Current characterized errata are available on request.

Contact your local Intel sales office or your distributor to obtain the latest specifications and before placing your product order.

Copies of documents which have an ordering number and are referenced in this document, or other Intel literature, may be obtained from Intel Corporation by going to the World Wide Web site at: <http://www.intel.com/> or by calling 1-800-548-4725.

Intel, Celeron and Pentium are trademarks or registered trademarks of Intel Corporation or its subsidiaries in the United States and other countries.

* Other names and brands may be claimed as the property of others.

Copyright © 2003, Intel Corporation. All rights reserved.

Preface

This Product Guide gives information about board layout, component installation, BIOS Setup menus, and regulatory requirements for Intel® Desktop Board D845GVSR.

Intended Audience

The Product Guide is intended for technically qualified personnel. It is not intended for general audiences.

Information Layout

The chapters in this Product Guide are arranged as follows:

[1 Desktop Board Features](#): a summary of product features.

[2 Installing and Replacing Desktop Board Components](#): instructions on how to install the desktop board and other hardware components.

[3 Updating the BIOS](#): instructions on how to update the BIOS.

[4 Using the BIOS Setup Program](#): contents of the BIOS Setup menus and submenus

[5 Desktop Board Resources](#): information about desktop board resources.

[A Error Messages and Indicators](#): information about BIOS error messages and beep codes.

[B Regulatory Compliance](#): safety and EMC regulations, product certification.

Conventions

The following conventions are used in this manual:



WARNING

Warnings indicate conditions that, if not observed, can cause personal injury.



CAUTION

Cautions warn the user about how to prevent damage to hardware or loss of data.



NOTE

Notes call attention to important information.

Terminology

The table below gives descriptions to some common terms used in the product guide.

Term	Description
GB	Gigabyte (1,073,741,824 bytes)
GHz	Gigahertz (one billion hertz)
KB	Kilobyte (1024 bytes)
MB	Megabyte (1,048,576 bytes)
Mbit	Megabit (1,048,576 bits)
MHz	Megahertz (one million hertz)

Box Contents

- Intel Desktop Board
- I/O shield
- One IDE cable
- One diskette drive cable
- Quick Reference Guide
- Configuration and battery caution statement label
- Intel® Express Installer CD-ROM

Contents

1 Desktop Board Features

Desktop Board Components	11
Processor	13
Main Memory	14
Intel® 845GV Chipset	15
Audio Subsystem	15
LAN Subsystem (Optional)	16
LAN Subsystem Software	16
RJ-45 LAN Connector LEDs	16
Hi-Speed USB 2.0 Support	16
Enhanced IDE Interface	17
Expansion Slots	17
BIOS	17
PCI Auto Configuration	17
IDE Auto Configuration	17
Security Passwords	18
Power Management Features	18
Speaker	20
Battery	20
Real-Time Clock	20

2 Installing and Replacing Desktop Board Components

Before You Begin	21
Installation Precautions	22
Installation Instructions	22
Installing the I/O Shield	24
Installing and Removing the Desktop Board	25
Installing and Removing a Processor	26
Installing a Processor	26
Installing the Processor Fan Heatsink	26
Connecting the Processor Fan Heatsink Cable	27
Removing a Processor	27
Installing and Removing Memory	28
Installing DIMMs	28
Removing DIMMs	29
Connecting the IDE Cable	30
Connecting Internal Headers	31
Connecting the Front Panel Header	32
Installing a Front Panel Audio Solution	32
Installing a USB 2.0 Solution	33
Connecting Hardware Control and Power Cables	34
Connecting Hardware Control Cables	35
Connecting Power Cables	35

Connecting Add-In Card and Peripheral Interface Connectors	36
Setting the BIOS Configuration Jumper Block	37
Clearing Passwords	38
Back Panel Connectors	39
Replacing the Battery	40
3 Updating the BIOS	
Updating the BIOS with the Intel® Express BIOS Update Utility	45
Updating the BIOS with the Intel® Iflash BIOS Update Utility	45
Obtaining the BIOS Update File	45
Updating the BIOS	46
Recovering the BIOS	46
4 Using the BIOS Setup Program	
Maintenance Menu	50
Main Menu	51
Advanced Menu	52
PCI Configuration Submenu	53
Boot Configuration Submenu	54
Peripheral Configuration Submenu	55
IDE Configuration Submenu	57
Primary/Secondary IDE Master/Slave Submenus	58
Diskette Configuration Submenu	60
Event Log Configuration Submenu	61
Video Configuration Submenu	62
USB Configuration Submenu	63
Chipset Configuration Submenu	64
Security Menu	66
Power Menu	67
ACPI Submenu	68
Boot Menu	69
Boot Device Priority Submenu	70
Hard Disk Drives Submenu	71
Removable Devices Submenu	72
ATAPI CD-ROM Drives	73
Exit Menu	74
5 Desktop Board Resources	
Memory Map	75
DMA Channels	75
Interrupts	76
A Error Messages and Indicators	
BIOS Beep Codes	77
BIOS Error Messages	78

B Regulatory Compliance

Safety Regulations	81
European Union Declaration of Conformity Statement	81
Product Ecology Statements	82
EMC Regulations	83
Product Certification Markings (Board Level)	84

Figures

1. Desktop Board Components	11
2. Location of Standby Power Indicator.....	19
3. Installing the I/O Shield	24
4. Desktop Board Mounting Screw Holes.....	25
5. Installing a Processor.....	26
6. Connecting the Processor Fan Heatsink Cable to the Processor Fan Header	27
7. Installing Memory.....	28
8. Connecting the IDE Cable.....	30
9. Internal Headers	31
10. Location of Hardware Control and Power Connectors	34
11. Add-in Card and Peripheral Interface Connectors.....	36
12. Location of the BIOS Configuration Jumper Block	37
13. Back Panel Connectors	39
14. Removing the Battery from the Desktop Board.....	43

Tables

1. Feature Summary	9
2. Desktop Board Components	12
3. Processors Supported by the Desktop Board	13
4. Memory Support	14
5. RJ-45 LAN Connector LEDs	16
6. Front Panel Header (J9G1).....	32
7. Front Panel Audio Header Signal Names (J8A1)	32
8. USB 2.0 Header (J9F2)	33
9. Jumper Settings for the BIOS Setup Program Modes (J9H2)	37
10. BIOS Setup Program Menu Bar.....	49
11. BIOS Setup Program Function Keys.....	50
12. Maintenance Menu	50
13. Main Menu.....	51
14. Advanced Menu.....	52
15. PCI Configuration Submenu	53
16. Boot Configuration Submenu	54
17. Peripheral Configuration Submenu	55
18. IDE Configuration Submenu	57
19. Primary/Secondary IDE Master/Slave Submenus.....	58
20. Diskette Configuration Submenu	60
21. Event Log Configuration Submenu	61
22. Video Configuration Submenu	62
23. USB Configuration Submenu	63
24. Chipset Configuration Submenu	64
25. Security Menu.....	66
26. Power Menu.....	67
27. ACPI Submenu	68
28. Boot Menu	69
29. Boot Device Priority Submenu	70
30. Hard Disk Drives Submenu.....	71
31. Removable Devices Submenu.....	72
32. ATAPI CD-ROM Drives Submenu.....	73
33. Exit Menu.....	74
34. System Memory Map.....	75
35. DMA Channels.....	75
36. Interrupts	76
37. Beep Codes	77
38. BIOS Error Messages.....	78
39. Safety Regulations.....	81
40. EMC Regulations.....	83
41. Product Certification Markings	84

1 Desktop Board Features

Table 1 describes the major features of Intel® Desktop Board D845GVSR.

Table 1. Feature Summary

Form Factors	MicroATX at 9.2 inches by 8.2 inches
Processor	Support for: <ul style="list-style-type: none"> • Intel® Pentium® 4 processor in an mPGA-478 socket with a 533/400 MHz system bus • Intel® Celeron® processor in an mPGA-478 socket with a 400 MHz system bus
Memory	<ul style="list-style-type: none"> • Two 184-pin DDR SDRAM DIMM sockets, 2.5 V • Support for DDR333/266/200 MHz DIMMs • Supports up to 2 GB of system memory with DIMMs utilizing 512 Mbit technology DRAM devices
Chipset	Intel® 845GV chipset, consisting of: <ul style="list-style-type: none"> • Intel® 82845GV Graphics and Memory Controller Hub (GMCH) • Intel® 82801DB I/O Controller Hub (ICH4) • 4 Mbit Firmware Hub (FWH)
Audio	<ul style="list-style-type: none"> • Intel 845GV chipset (AC '97) • Realtek ALC202A codec
LAN (Optional)	Intel® 82562ET 10/100 Mbit/sec Platform LAN Connect (PLC) device and RJ-45 connector
Graphics	Integrated graphics
I/O Control	SMSC LPC47M172 low pin count (LPC) interface I/O controller
Expansion Capabilities	Three PCI slots
Peripheral Interfaces	<ul style="list-style-type: none"> • Up to six USB 2.0 ports <ul style="list-style-type: none"> — Four ports routed to the back panel — Two ports routed to the USB 2.0 header • Two IDE interfaces with Ultra DMA-33 and ATA-66/100 support • One diskette drive interface • One parallel port • One serial port • One VGA port • PS/2* keyboard and mouse ports
BIOS	<ul style="list-style-type: none"> • Intel/AMI BIOS • Intel® Rapid BIOS Boot • Intel® Express BIOS Update • SMBIOS support
Power Management	<ul style="list-style-type: none"> • Support for Advanced Configuration and Power Interface (ACPI) • Hardware support for power, fan, and chassis intrusion connectors, Suspend to RAM, resume on ring, wake from USB and PS/2 keyboard and mouse, and PME# wakeup.

 **NOTE**

For information about this Intel desktop board, including the Technical Product Specification (TPS), BIOS updates, and device drivers, go to the Intel World Wide Web site at:

<http://support.intel.com/support/motherboards/desktop/>

Supported Operating Systems

The desktop board supports the following operating systems:

- Microsoft Windows* 98 SE
- Microsoft Windows Me
- Microsoft Windows 2000
- Microsoft Windows XP

Desktop Board Components

Figure 1 shows the location of the major components on Desktop Board D845GVSr.

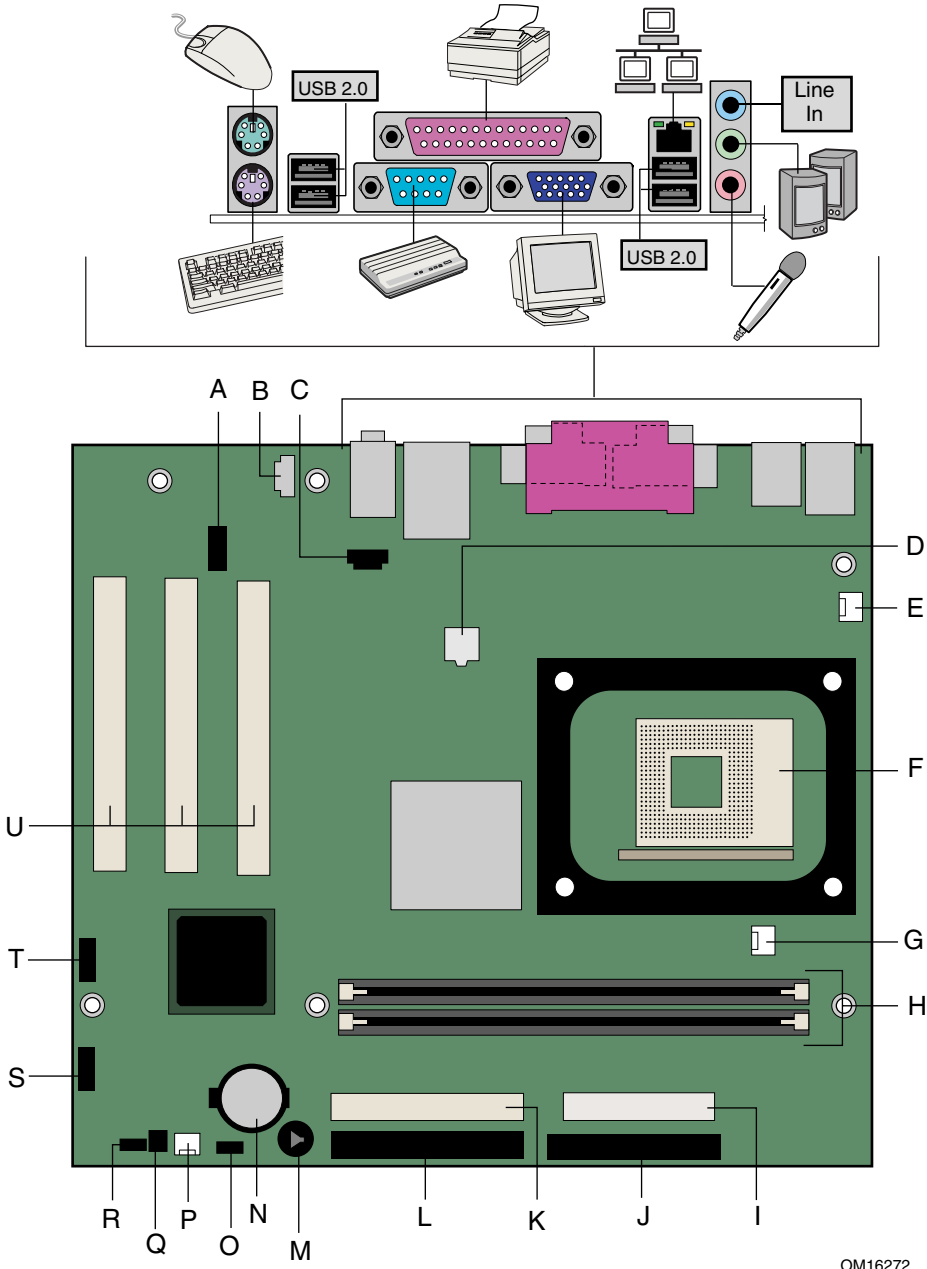

Figure 1. Desktop Board Components

Table 2. Desktop Board Components

Item	Description
A	Front panel audio header
B	Auxiliary line-in header
C	CD-in (ATAPI) header
D	12 V power connector
E	Rear chassis fan header
F	Processor socket
G	Processor fan header
H	DIMM sockets
I	Main power connector
J	Diskette drive connector
K	Secondary IDE connector
L	Primary IDE connector
M	Speaker
N	Battery
O	Auxiliary front panel power LED connector
P	Front chassis fan header
Q	Chassis intrusion header
R	BIOS
S	Front panel header
T	Front panel USB header
U	PCI connectors

Related Links:

Go to the following links for more information about Intel Desktop Board D845GVSR:

- <http://www.intel.com/design/motherbd>
- <http://support.intel.com/support/motherboards/desktop>

Processor



CAUTION

Failure to use an ATX12V or SFX-12V power supply, or not connecting the additional power supply lead to Desktop Board D845GVSR may result in damage to the desktop board and/or power supply.

Desktop Board D845GVSR supports a single Intel Pentium 4 processor or Intel Celeron processor. Processors are not included with the desktop board and must be purchased separately.

The processor connects to the desktop board through the mPGA-478-pin socket. The Intel Pentium 4 processor or Intel Celeron processor may be removed and replaced with supported higher speed processors.

Desktop Board D845GVSR supports the processors listed in Table 3.

Table 3. Processors Supported by the Desktop Board

Type	Designation (GHz)	System Bus (MHz)	L2 Cache (KB)
Intel® Pentium® 4 processor with HT Technology	3.06	533	512
Intel Pentium 4 processor	2.80, 2.66, 2.53, 2.40B, and 2.26	533	512
	2.60, 2.50, 2.40, 2.20, 2A, 1.80A, and 1.60A	400	512
	2, 1.90, 1.80, 1.70, 1.60, and 1.50	400	256
Intel® Celeron® processor	2.60, 2.50, 2.40, 2.30, 2.20, 2.10, 2.0, 1.80, and 1.70	400	128

Desktop Board D845GVSR requires an ATX12V compliant power supply to function according to desktop board specifications. The board has two ATX12V compliant power supply connectors that are needed to provide extra power to the Intel 845GV chipset and Intel processor.

Related Links:

Go to the following links or pages for more information about:

- Supported Intel processors for Desktop Board D845GVSR
<http://support.intel.com/support/motherboards/desktop/>
- Instructions on installing or upgrading the processor, see page 26 in Chapter 2
- The location of the two power connectors, see page 34 in Chapter 2.

Main Memory

NOTE

To be fully compliant with all applicable Intel® SDRAM memory specification addendums, the desktop board should be populated with DIMMs that support the Serial Presence Detect (SPD) data structure. If your memory modules do not support SPD, you will see a notification to this effect on the screen at power up. The BIOS will attempt to configure the memory controller for normal operation.

NOTE

All memory components and DIMMs used with the desktop board must comply with the PC SDRAM specifications. These include the PC SDRAM Specification (memory component specific) and the PC Unbuffered DIMM Specification.

The desktop board supports single channel memory configurations defined in Table 4.

Table 4. Memory Support

Memory Speed	Processor	System Bus (MHz)	Memory Speed Outcome (MHz)
DDR 333	Pentium 4 processor	533	333
	Pentium 4 processor or Celeron processor	400	266
DDR266	Pentium 4 processor	533 or 400	266
	Celeron processor	400	266
DDR200	Pentium 4 processor or Celeron processor	400	200

- Two 2.5 V 184-pin DDR DIMM sockets with gold-plated contacts
- Serial Presence Detect (SPD)
- Unbuffered, non-ECC RAM (registered memory is not supported)
- Support for 64 Mb, 128 Mb, 256 Mb, and 512 Mb memory technologies for the following memory configurations:
 - 64 MB to 256 MB utilizing 64 Mb technology
 - Up to 512 MB utilizing 128 Mb technology
 - Up to 1.0 GB utilizing 256 Mb technology
 - Up to 2 GB utilizing 512 MB technology

Related Links:

Go to the following links or pages for more information about:

- The latest list of tested memory, <http://support.intel.com/support/motherboards/desktop/>
- SDRAM specifications, <http://www.intel.com/technology/memory/pcsdram/spec/>
- Installing memory, page 28 in Chapter 2

Intel® 845GV Chipset

The Intel 845GV chipset consists of the following:

- Intel 82845GV Graphics and Memory Controller Hub (GMCH) with AHA bus
- Intel 82801DB I/O Controller Hub (ICH4) with AHA bus
- Firmware Hub (FWH)

Related Link:

Go to the following link for more information about the Intel 845GV chipset:

<http://developer.intel.com/design/nav/pcserver.htm>

Audio Subsystem

The audio subsystem features the following:

- Intel 845GV chipset (AC '97)
- Realtek ALC202A codec

The audio subsystem supports the following audio interfaces:

- ATAPI-style connectors:
 - Auxiliary line in
 - CD-ROM
- Front panel audio connector
- Back panel connectors:
 - Line out
 - Line in
 - Mic in



NOTE

The line out connector, located on the back panel, is designed to power either headphones or amplified speakers only. Poor audio quality may occur if passive (non-amplified) speakers are connected to this output.

Related Links:

Go to the following link or pages for more information about:

- Audio drivers and utilities, <http://support.intel.com/support/motherboards/desktop/>
- Installing a front panel audio solution, page 32 in Chapter 2

LAN Subsystem (Optional)

The optional Intel 82562ET (with the Intel 82801DB ICH4) provides a Fast PCI LAN subsystem providing both 10Base-T and 100Base-TX connectivity. The Intel 82562ET provides the following functions:

- Basic 10/100 Ethernet LAN connectivity
- Support for RJ-45 connector with status indicator LEDs
- Programmable transit threshold
- Configurable EEPROM that contains the MAC address

LAN Subsystem Software

For LAN software and drivers, refer to the D845GVSR link on Intel's World Wide Web site at:

<http://support.intel.com/support/motherboards/desktop/>

RJ-45 LAN Connector LEDs

Two LEDs are built into the RJ-45 LAN connector. Table 5 describes the LED states when the desktop board is powered up and the LAN subsystem is operating.

Table 5. RJ-45 LAN Connector LEDs

LED Color	LED State	Indicates
Green	Off	10 Mbit/sec data rate is selected.
	On	100 Mbit/sec data rate is selected.
Yellow	Off	LAN link is not established.
	On (steady state)	LAN link is established.
	On (brighter and pulsing)	The computer is communicating with another computer on the LAN.

Hi-Speed USB 2.0 Support

NOTE

Computer systems that have an unshielded cable attached to a USB port might not meet FCC Class B requirements, even if no device or a low-speed USB device is attached to the cable. Use a shielded cable that meets the requirements for a full-speed USB device.

This desktop board supports up to six USB 2.0 ports via ICH4; four ports routed to the back panel and two routed to a USB front panel header. USB 2.0 ports are backward compatible with USB 1.1 devices. USB 1.1 devices will function normally at USB 1.1 speeds.

Disabling Hi-Speed USB in the BIOS reverts all USB 2.0 ports to USB 1.1 operation. This may be required to accommodate operating systems that do not support USB 2.0.

Enhanced IDE Interface

The ICH4's IDE interface handles the exchange of information between the processor and peripheral devices like hard disks, CD-ROM drives, and Iomega Zip* drives inside the computer. The interface supports:

- Up to four IDE devices (such as hard drives)
- ATAPI devices (such as CD-ROM drives)
- Older PIO Mode devices
- Ultra DMA-33 and ATA-66/100 protocols
- Laser Servo (LS-120) drives

Expansion Slots

Desktop Board D845GVSR has three PCI bus add-in card connectors.

BIOS

The BIOS provides the Power-On Self-Test (POST), the BIOS Setup program, the PCI and IDE auto-configuration utilities, and the video BIOS. The BIOS is stored in the firmware hub.

The BIOS can be updated by following the instructions in Chapter 3 on page 45.

PCI Auto Configuration

If you install a PCI add-in card in your computer, the PCI auto-configuration utility in the BIOS automatically detects and configures the resources (IRQs, DMA channels, and I/O space) for that add-in card. You do not need to run the BIOS Setup program after you install a PCI add-in card.

IDE Auto Configuration

If you install an IDE device (such as a hard drive) in your computer, the IDE auto-configuration utility in the BIOS automatically detects and configures the device for your computer. You do not need to run the BIOS Setup program after installing an IDE device. You can override the auto-configuration options by specifying manual configuration in the BIOS Setup program.

To use ATA-66/100 features, the following items are required:

- An ATA-66/100 peripheral device
- An ATA-66/100 compatible cable
- ATA-66/100 operating system device drivers

Security Passwords

The BIOS includes security features that restrict whether the BIOS Setup program can be accessed and who can boot the computer. A supervisor password and a user password can be set for the Setup and for booting the computer, with the following restrictions:

- The supervisor password gives unrestricted access to view and change all Setup options. If only the supervisor password is set, pressing <Enter> at the password prompt of Setup gives the user restricted access to Setup.
- If both the supervisor and user passwords are set, you must enter either the supervisor password or the user password to access Setup. Setup options are then available for viewing and changing depending on whether the supervisor or user password was entered.
- Setting a user password restricts who can boot the computer. The password prompt is displayed before the computer is booted. If only the supervisor password is set, the computer boots without asking for a password. If both passwords are set, you can enter either password to boot the computer.

Power Management Features

- Advanced Configuration and Power Interface (ACPI)
- Hardware support:
 - Power connectors
 - Fan connectors
 - Chassis intrusion
 - Suspend to RAM (Instantly Available PC technology)
 - Wake from USB
 - Wake from PS/2 keyboard/mouse
 - PME# wakeup support

ACPI

ACPI gives the operating system direct control over the power management and Plug & Play functions of a computer. The use of ACPI with the desktop board requires an operating system that provides full ACPI support.

Power Connectors

The desktop board has two power connectors. See Figure 10 on page 34 for the location of the power connectors.

Fan Connectors

The desktop board has two chassis fan headers and one processor fan header. See Figure 10 on page 34 for the location of the fan headers.

Chassis Intrusion

The board supports a chassis security feature that detects if the chassis cover has been removed. The security feature uses a mechanical switch on the chassis that can be connected to the chassis intrusion header on the desktop board. See Figure 10 on page 34 for the location of the chassis intrusion header.

Suspend to RAM (Instantly Available PC Technology)



CAUTION

For Instantly Available PC technology, the 5 V standby line for the power supply must be capable of delivering adequate +5 V standby current. Failure to provide adequate standby current when using this feature can damage the power supply and/or effect ACPI S3 sleep state functionality.

Instantly Available PC technology enables the board to enter the ACPI S3 (Suspend-to-RAM) sleep state. While in the S3 sleep state, the computer will appear to be off. When signaled by a wake-up device or event, the system quickly returns to its last known awake state.

The desktop board's standby power indicator, shown in Figure 2, is lit when there is standby power to the system. This includes the memory modules and PCI bus connectors, even when the computer appears to be off.

If the system has a dual-colored power LED on the front panel, the sleep state is indicated by the LED turning amber.

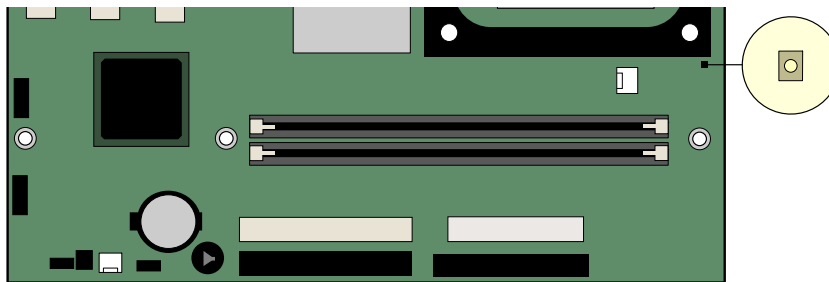

OM16273

Figure 2. Location of Standby Power Indicator



CAUTION

Power supplies used with this desktop board must be able to provide enough standby current to support the standard Instantly Available (ACPI S3 sleep state) configuration. If the standby current necessary to support multiple wake events from the PCI and/or USB buses exceeds power supply capacity, the desktop board may lose register settings stored in memory.

Related Links:

For more information on standby current requirements, navigate to the TPS by first selecting the desktop board from the following link:

<http://support.intel.com/support/motherboards/desktop/>

Wake from USB

USB bus activity wakes the computer from an ACPI S1 or S3 state.



NOTE

Wake from USB requires the use of a USB peripheral that supports Wake from USB.

Wake from PS/2 Keyboard/Mouse

PS/2 keyboard/mouse activity wakes the computer from an ACPI S1 or S3 state.

PME# Wakeup Support

When the PME# signal on the PCI bus is asserted, the computer wakes from an ACPI S1, S3, or S5 state.

Speaker

A speaker is mounted on the desktop board. The speaker provides audible error code (beep code) information during the Power-On Self-Test (POST).

Battery

A battery on the desktop board keeps the values in CMOS RAM and the clock current when the computer is turned off. See Chapter 2 starting on page 21 for instructions on how to replace the battery.

Real-Time Clock

The desktop board has a time-of-day clock and 100-year calendar. The battery on the desktop board keeps the clock current when the computer is turned off.

2 Installing and Replacing Desktop Board Components

This chapter tells you how to:

- Install the I/O shield
- Install and remove the desktop board
- Install and remove a processor
- Install and remove memory
- Connect the IDE cable
- Connect internal headers
- Connect hardware control and power cables
- Connect add-in card and peripheral interface connectors
- Set the BIOS configuration jumper block
- Clear passwords
- Connect back panel connectors
- Replace the battery

Before You Begin



WARNINGS

The procedures in this chapter assume familiarity with the general terminology associated with personal computers and with the safety practices and regulatory compliance required for using and modifying electronic equipment.

Disconnect the computer from its power source and from any telecommunications links, networks, or modems before performing any of the procedures described in this chapter. Failure to disconnect power, telecommunications links, networks, or modems before you open the computer or perform any procedures can result in personal injury or equipment damage. Some circuitry on the board can continue to operate even though the front panel power button is off.



CAUTION

Many of the midboard and front panel connectors provide operating voltage (+5 V dc and +12 V dc, for example) to devices inside the computer chassis, such as fans and internal peripherals. These connectors are not overcurrent protected. Do not use these connectors for powering devices external to the computer chassis. A fault in the load presented by the external devices could cause damage to the computer, the interconnecting cable, and the external devices themselves.

Follow these guidelines before you begin:

- Always follow the steps in each procedure in the correct order.
- Set up a log to record information about your computer, such as model, serial numbers, installed options, and configuration information.
- Electrostatic discharge (ESD) can damage components. Perform the procedures described in this chapter only at an ESD workstation using an antistatic wrist strap and a conductive foam pad. If such a station is not available, you can provide some ESD protection by wearing an antistatic wrist strap and attaching it to a metal part of the computer chassis.

Installation Precautions

When you install and test the Intel desktop board, observe all warnings and cautions in the installation instructions.

To avoid injury, be careful of:

- Sharp pins on connectors
- Sharp pins on printed circuit assemblies
- Rough edges and sharp corners on the chassis
- Hot components (like processors, voltage regulators, and heat sinks)
- Damage to wires that could cause a short circuit

Observe all warnings and cautions that instruct you to refer computer servicing to qualified technical personnel.

Installation Instructions



CAUTION

Follow these guidelines to meet safety and regulatory requirements when installing this board.

Read and adhere to all of these instructions and the instructions supplied with the chassis and associated modules. If the instructions for the chassis are inconsistent with these instructions or the instructions for associated modules, contact the supplier's technical support to find out how you can ensure that your computer meets safety and regulatory requirements. If you do not follow these instructions and the instructions provided by chassis and module suppliers, you increase safety risk and the possibility of noncompliance with regional laws and regulations.

Ensure Electromagnetic Compatibility (EMC) Compliance

Before computer integration, make sure that the power supply and other modules or peripherals, as applicable, have passed Class B EMC testing and are marked accordingly.

Pay close attention to the following when reading the installation instructions for the host chassis, power supply, and other modules:

- Product certifications or lack of certifications
- External I/O cable shielding and filtering

- Mounting, grounding, and bonding requirements
- Keying connectors when mating the wrong connectors could be hazardous

If the power supply and other modules or peripherals, as applicable, are not Class B EMC compliant before integration, then EMC testing is required on a representative sample of the newly completed computer.

Chassis and Component Certifications

Ensure that the chassis and certain components; such as the power supply, peripheral drives, wiring, and cables; are components certified for the country or market where used. Agency certification marks on the product are proof of certification. Typical product certifications include:

- **In Europe**

The CE marking signifies compliance with all applicable European requirements. If the chassis and other components are not properly CE marked, a supplier's Declaration of Conformity statement to the European EMC directive and Low Voltage directive (as applicable), should be obtained. Additionally, other directives, such as the Radio and Telecommunications Terminal Equipment (R&TTE) directive may also apply depending on product features.

- **In the United States**

A certification mark by a Nationally Recognized Testing Laboratory (NRTL) such as UL, CSA, or ETL signifies compliance with safety requirements. Wiring and cables must also be UL listed or recognized and suitable for the intended use. The FCC Class B logo for home or office use signifies compliance with electromagnetic interference (EMI) requirements.

- **In Canada**

A nationally recognized certification mark such as CSA or cUL signifies compliance with safety requirements. The Industry Canada statement at the front of this product guide demonstrates compliance with Canadian EMC regulations. Industry Canada recognizes and accepts FCC certification as denoting compliance with national electromagnetic interference (emissions) requirements.

Prevent Power Supply Overload

Do not overload the power supply output. To avoid overloading the power supply, make sure that the calculated total current loads of all the modules within the computer is less than the output current rating of each of the power supplies' output circuits.

Place Battery Marking

There is insufficient space on this Desktop Board to provide instructions for replacing and disposing of the Lithium ion coin cell battery. For system safety certification, the following statement or equivalent statement is required to be permanently and legibly marked on the chassis near the battery.



CAUTION

Risk of explosion if the battery is replaced with an incorrect type. Batteries should be recycled where possible. Disposal of used batteries must be in accordance with local environmental regulations.

Related Links:

For information about replacing the battery, go to page 40 in Chapter 2.

Use Only for Intended Applications

All Intel desktop boards are evaluated as Information Technology Equipment (I.T.E.) for use in personal computers for installation in homes, offices, schools, computer rooms, and similar locations. The suitability of this product for other applications or environments, such as medical, industrial, alarm systems, test equipment, etc. may require further evaluation.

Related Links:

For information about regulatory compliance, go to Appendix B on page 81.

Installing the I/O Shield

The desktop board comes with an I/O shield. When installed in the chassis, the shield blocks radio frequency transmissions, protects internal components from dust and foreign objects, and promotes correct airflow within the chassis.

Install the I/O shield before installing the desktop board in the chassis. Place the shield inside the chassis as shown in Figure 3. Press the shield into place so that it fits tightly and securely. If the shield doesn't fit, obtain a properly-sized shield from the chassis supplier.

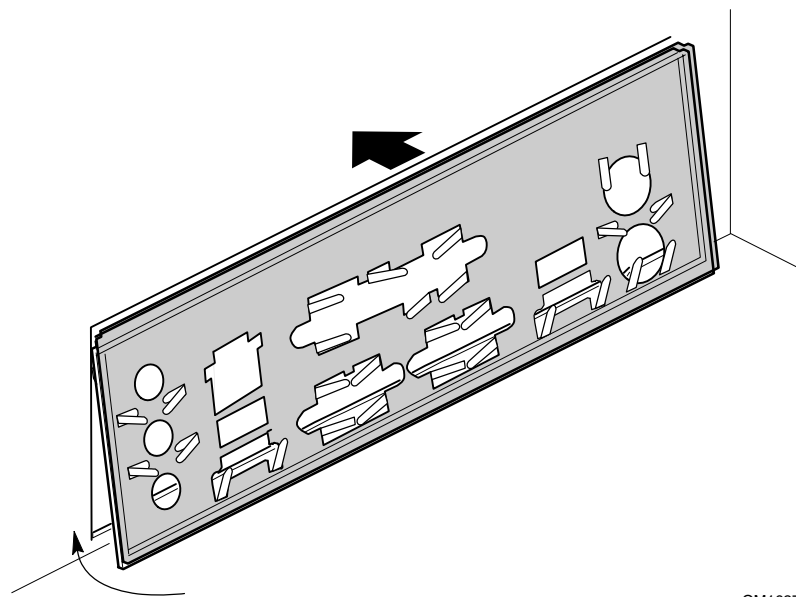

OM16274

Figure 3. Installing the I/O Shield

Installing and Removing the Desktop Board

Refer to your chassis manual for instructions on installing and removing the desktop board.

WARNING

This procedure should be done only by qualified technical personnel. Disconnect the computer from its power source before performing the procedures described here. Failure to disconnect the power before you open the computer can result in personal injury or equipment damage.

Figure 4 shows the location of the six mounting holes for Desktop Board D845GVSR.

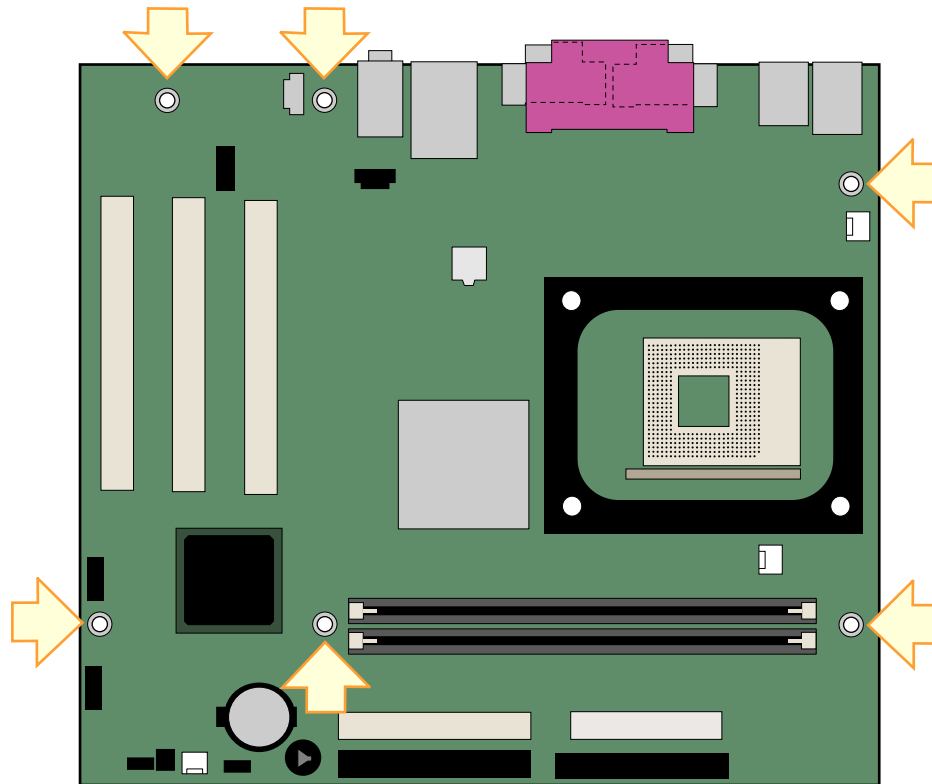

OM16275

Figure 4. Desktop Board Mounting Screw Holes

Installing and Removing a Processor

Instructions on how to install the processor to the desktop board are given below.

Installing a Processor



CAUTION

Before installing or removing the processor, make sure that AC power has been removed by unplugging the power cord from the computer; the standby power LED should not be lit (see Figure 2 on page 19). Failure to do so could damage the processor and the desktop board.

To install a processor, follow these instructions:

1. Observe the precautions in “Before You Begin” on page 21.
2. Locate the processor socket and raise the socket lever completely.
3. Install the processor so that the corner with the gold triangle marking (A) is aligned with the corner where the lever is attached to the socket (see Figure 5).
4. Lower the lever to its original position.

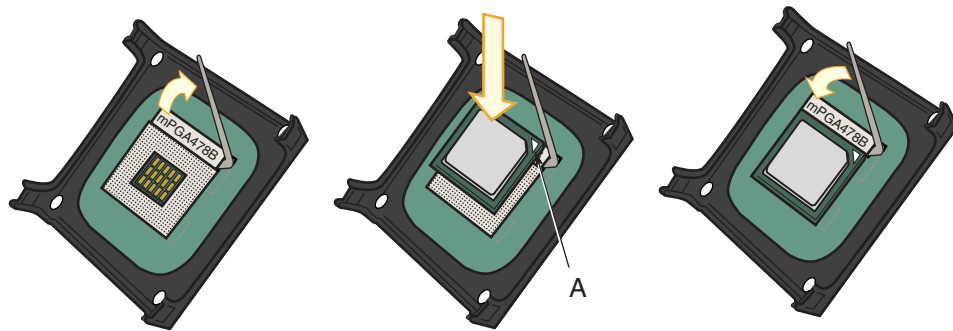

OM15228

Figure 5. Installing a Processor

Installing the Processor Fan Heatsink

The desktop board has an integrated processor fan heatsink retention mechanism (RM). For instructions on how to install the processor fan heatsink to the integrated processor fan heatsink RM, refer to the Intel World Wide Web site at:

<http://support.intel.com/support/processors/pentium4/intnotes478.htm>

Connecting the Processor Fan Heatsink Cable

Connect the processor fan heatsink cable to the processor fan header (see Figure 6).

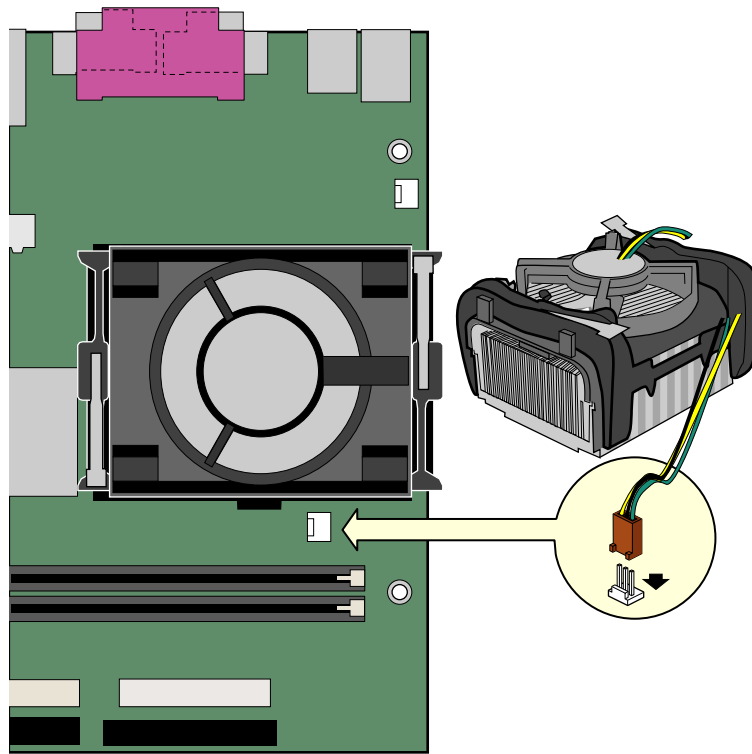

OM16276

Figure 6. Connecting the Processor Fan Heatsink Cable to the Processor Fan Header

Removing a Processor

For instruction on how to remove the processor fan heatsink, refer to the Intel World Wide Web site at:

<http://support.intel.com/support/processors/pentium4/intnotes478.htm>

Installing and Removing Memory



CAUTION

To be fully compliant with all applicable Intel SDRAM memory specification addendums, the board requires DIMMs that support the Serial Presence Detect (SPD) data structure. You can access the PC Serial Presence Detect Specification at:

<http://www.intel.com/technology/memory/pcsdram/spec/>

The desktop board has two DIMM sockets arranged as DIMM 0 and DIMM 1, as shown in Figure 7. If installing a single DIMM, install it in DIMM 0.

Refer to the Main Memory heading on page 14 for memory requirements.

Installing DIMMs

To install DIMMs, follow these steps:

1. Observe the precautions in “Before You Begin” on page 21.
2. Turn off all peripheral devices connected to the computer. Turn off the computer and disconnect the AC power cord.
3. Remove the computer’s cover and locate the DIMM sockets (see Figure 7).

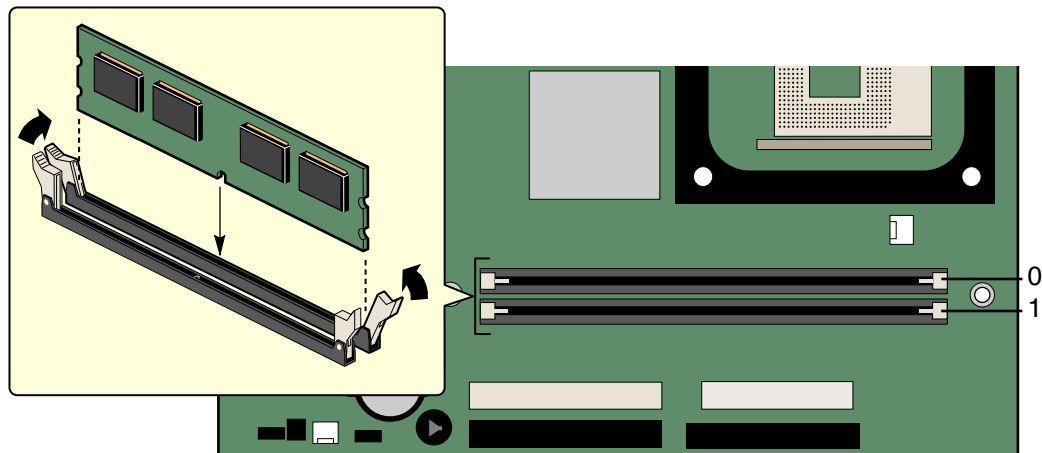

OM16277

Figure 7. Installing Memory

4. Make sure the clips at either end of the DIMM socket(s) are pushed outward to the open position.
5. Position the DIMM above the socket. Align the two small notches in the bottom edge of the DIMM with the keys in the socket (see inset in Figure 7).
6. Insert the bottom edge of the DIMM into the socket.
7. When the DIMM is inserted, push down on the top edge of the DIMM until the retaining clips snap into place. Make sure the clips are firmly in place.
8. Replace the computer's cover and reconnect the AC power cord.

Removing DIMMs

To remove a memory module, follow these steps:

1. Observe the precautions in "Before You Begin" on page 21.
2. Turn off all peripheral devices connected to the computer. Turn off the computer.
3. Remove the AC power cord from the computer.
4. Remove the computer's cover.
5. Remove the AGP card, if necessary.
6. Gently spread the retaining clips at each end of the DIMM socket. The DIMM pops out of the socket.
7. Hold the DIMM by the edges, lift it away from the socket, and store it in an anti-static package.
8. Reinstall and reconnect any parts you removed or disconnected to reach the DIMM sockets.
9. Replace the computer's cover and reconnect the AC power cord.

Connecting the IDE Cable

The Intel® boxed desktop board package includes an IDE cable. The cable connects two drives to the desktop board. The cable supports both ATA-66 and ATA-100 transfer protocols and is backward compatible with drives using slower IDE transfer protocols. Figure 8 shows the correct installation of the cable.

 **NOTE**

ATA-66/100 compatible cables are backward compatible with drives using slower IDE transfer protocols. If an ATA-66/100 disk drive and a disk drive using any other IDE transfer protocol are attached to the same cable, the maximum transfer rate between the drives may be reduced to that of the slowest drive.

 **NOTE**

Do not connect an ATA device as a slave on the same IDE cable as an ATAPI master device. For example, do not connect an ATA hard drive as a slave to an ATAPI CD-ROM drive.

For correct function of the cable:

1. Observe the precautions in “Before You Begin” on page 21.
2. Attach the cable end with the single blue connector to the desktop board (see Figure 8, A).
3. Attach the cable end with the two closely spaced black and gray connectors to the drives (see Figure 8, B).

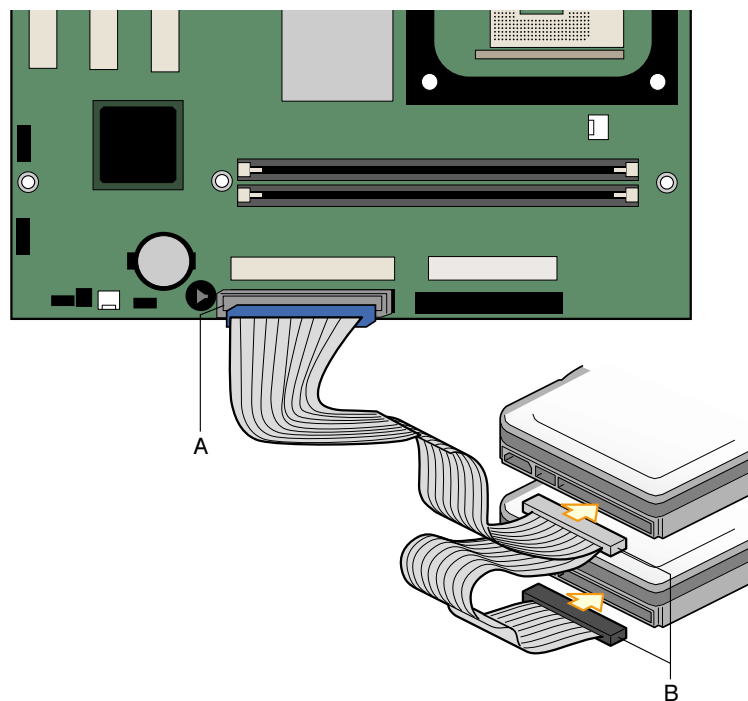

OM16278

Figure 8. Connecting the IDE Cable

Connecting Internal Headers

Follow the instructions below to connect the USB 2.0 solution, power LED, front panel, and audio solution. See Figure 9 for pin assignments.

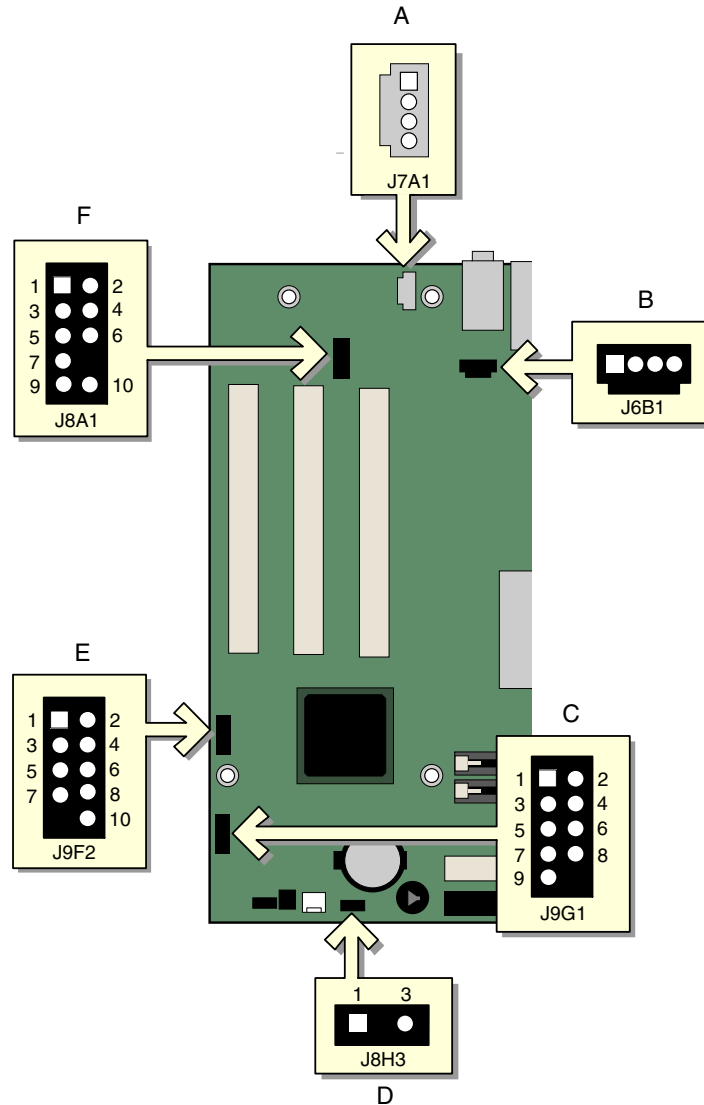

OM16279

Item	Description
A	Auxiliary-in
B	CD-in
C	Front panel
D	Power LED
E	Front panel USB 2.0
F	Front panel audio

Figure 9. Internal Headers

Connecting the Front Panel Header

Before connecting the front panel header, observe the precautions in “Before You Begin” on page 21. Table 6 shows the pin assignments for the front panel header.

Table 6. Front Panel Header (J9G1)

Pin	Signal	In/Out	Description	Pin	Signal	In/Out	Description
Hard Drive Activity LED				Power LED			
1	HD_PWR	Out	Hard disk LED pull-up (330 Ω) to +5 V	2	HDR_BLNK_GRN	Out	Front panel green LED
3	HDA#	Out	Hard disk active LED	4	HDR_BLNK_YEL	Out	Front panel yellow LED
Reset Switch				On/Off Switch			
5	Ground		Ground	6	FPBUT_IN	In	Power switch
7	FP_RESET#	In	Reset switch	8	Ground		Ground
Power				Not Connected			
9	+5 V		Power	10	N/C		Not connected

Installing a Front Panel Audio Solution

Table 7 shows the pin assignments for the front panel audio header.

Table 7. Front Panel Audio Header Signal Names (J8A1)

Pin	Signal Name	Pin	Signal Name
1	AUD-MIC	2	AUD-GND
3	AUD-MIC-BIAS	4	AUD-VCC
5	AUD-FPOUT-R	6	AUD-RET-R
7	NO CONNECTION	8	KEY
9	AUD-FPOUT-L	10	AUD-RET-L

To install the cable that connects a front panel audio solution to the front panel audio header, follow these steps:

1. Observe the precautions in “Before You Begin” on page 21.
2. Turn off all peripheral devices connected to the computer. Turn off the computer and disconnect the AC power cord.
3. Remove the cover. Locate the front panel audio header (J8A1).
4. Remove the three jumpers from the header (this disables the back panel audio connectors).
5. Install a correctly keyed and shielded front panel audio cable.
6. Connect the audio cable to the front panel audio solution.
7. Replace the cover.

To restore back panel operations, follow these steps:

1. Observe the precautions in “Before You Begin” on page 21.
2. Turn off all peripheral devices connected to the computer. Turn off the computer and disconnect the AC power cord.
3. Remove the cover. Remove the front panel audio cable.
4. Install a jumper on pins 5-6 (rear R channel).
5. Install a jumper on pins 9-10 (rear L channel).
6. Install a jumper on pins 1-2 (mic).
7. Replace the cover.

Installing a USB 2.0 Solution

Before installing a USB 2.0 solution, observe the precautions in “Before You Begin” on page 21. Table 8 shows the pin assignments for the USB 2.0 header.

Table 8. USB 2.0 Header (J9F2)

Pin	Signal Name	Pin	Signal Name
1	Power	2	Power
3	D-	4	D-
5	D+	6	D+
7	Ground	8	Ground
9	Key (no pin)	10	Not connected

Note: USB ports may be assigned as needed.

Connecting Hardware Control and Power Cables

Figure 10 shows the location of the hardware control headers and power connectors.

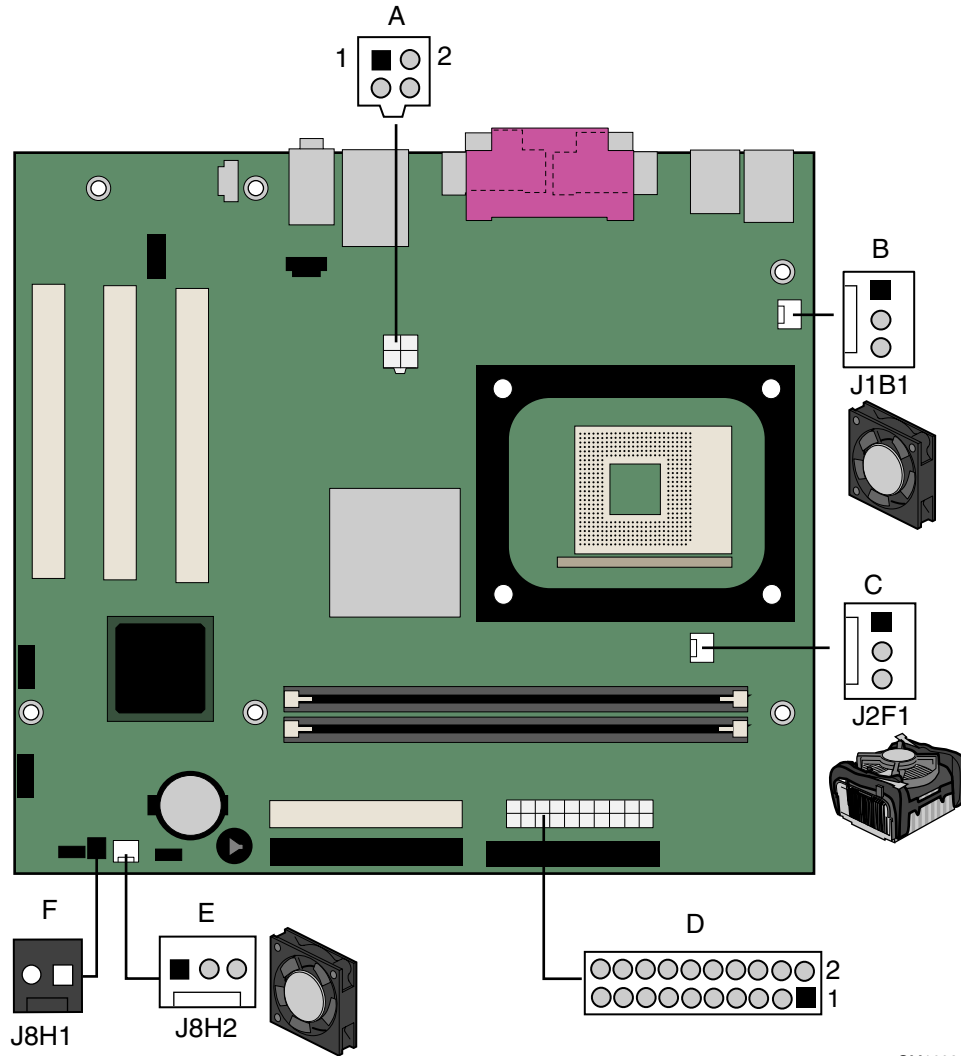

OM16280

Figure 10. Location of Hardware Control and Power Connectors

Connecting Hardware Control Cables

See Figure 10 for fan and chassis intrusion header locations. Connect the processor's fan heatsink cable to the processor fan header on the board. Connect chassis fan cables to the board fan headers. Connect the chassis intrusion cable to the respective header on the board.

Connecting Power Cables



CAUTION

Failure to use an ATX12V power supply, or not connecting the 12 V processor core voltage power supply connector to the desktop board may result in damage to the desktop board and/or power supply.

Figure 10 shows the location of the power connectors.

1. Observe the precautions in “Before You Begin” on page 21.
2. Connect the 12 V processor core voltage power supply cable to the 2x2 connector.
3. Connect the main power supply cable to the 2x10 connector.

Connecting Add-In Card and Peripheral Interface Connectors

Figure 11 shows the add-in card and peripheral interface connectors.

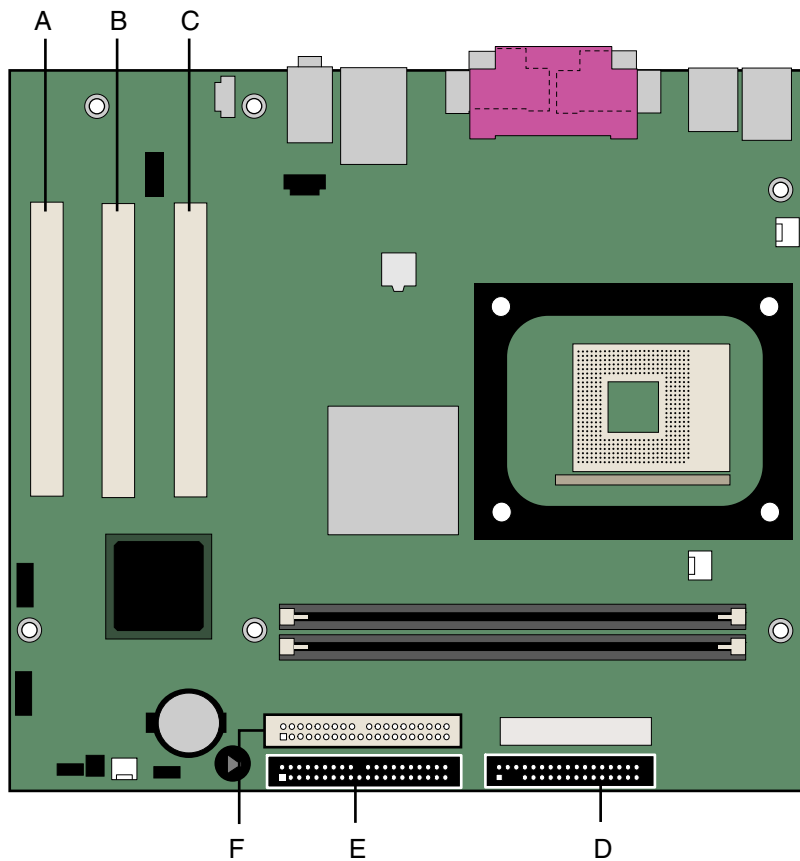

OM16281

Item	Description	Item	Description
A	PCI bus connector 3	D	Floppy drive
B	PCI bus connector 2 (SMBus routed)	E	Primary IDE
C	PCI bus connector 1	F	Secondary IDE

Figure 11. Add-in Card and Peripheral Interface Connectors

Setting the BIOS Configuration Jumper Block

Figure 12 shows the location of the BIOS configuration jumper block.

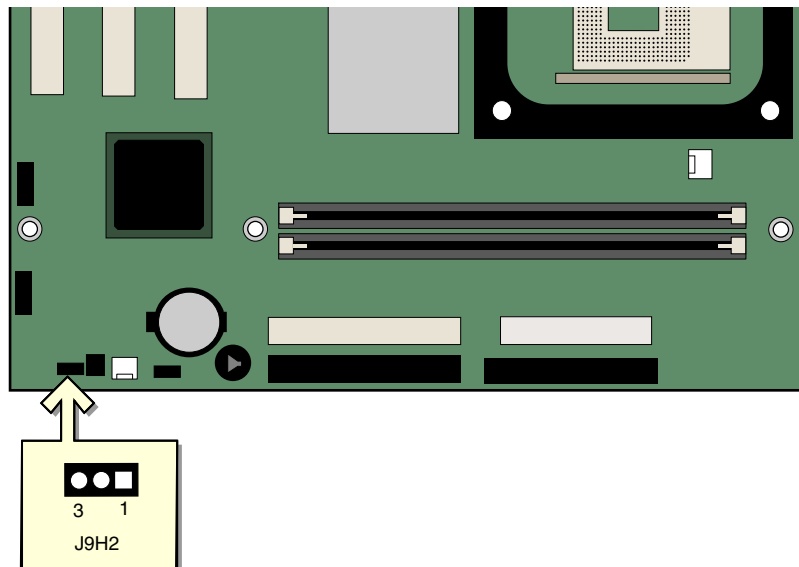

OM16282

Figure 12. Location of the BIOS Configuration Jumper Block

The three-pin BIOS jumper block enables all board configurations to be done in BIOS Setup. Table 9 shows the jumper settings for the Setup program modes.

Table 9. Jumper Settings for the BIOS Setup Program Modes (J9H2)

Jumper Setting	Mode	Description
	Normal (default) (1-2)	The BIOS uses the current configuration and passwords for booting.
	Configure (2-3)	After the Power-On Self-Test (POST) runs, the BIOS displays the Maintenance Menu. Use this menu to clear passwords.
	Recovery (None)	Recovers BIOS from a diskette in the event of a failed BIOS update.

Clearing Passwords

This procedure assumes that the board is installed in the computer and the configuration jumper block is set to normal mode.

1. Observe the precautions in “Before You Begin” on page 21.
2. Turn off all peripheral devices connected to the computer. Turn off the computer. Disconnect the computer’s power cord from the AC power source (wall outlet or power adapter).
3. Remove the computer cover.
4. Find the configuration jumper block (see Figure 12).
5. Place the jumper on pins 2-3 as shown below.



6. Replace the cover, plug in the computer, turn on the computer, and allow it to boot.
7. The computer starts the Setup program. Setup displays the maintenance menu.
8. Use the arrow keys to select Clear Passwords. Press <Enter> and Setup displays a pop-up screen requesting that you confirm clearing the password. Select Yes and press <Enter>. Setup displays the maintenance menu again.
9. Press <F10> to save the current values and exit Setup.
10. Turn off the computer. Disconnect the computer’s power cord from the AC power source.
11. Remove the computer cover.
12. To restore normal operation, place the jumper on pins 1-2 as shown below.



13. Replace the cover, plug in the computer, and turn on the computer.

Back Panel Connectors

NOTE

The line out connector, located on the back panel, is designed to power either headphones or amplified speakers only. Poor audio quality may occur if passive (non-amplified) speakers are connected to this output.

Figure 13 shows the back panel connectors.

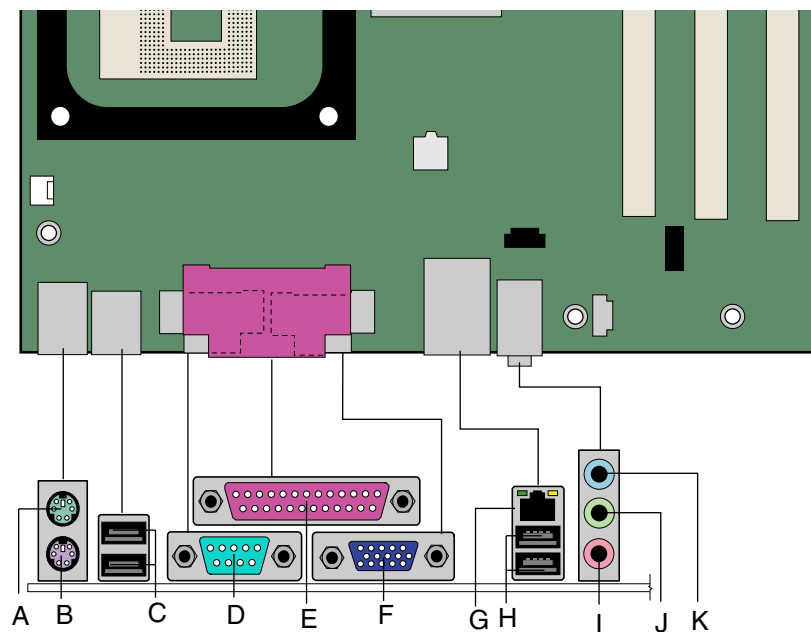

OM16283

Item	Description
A	PS/2 mouse port
B	PS/2 keyboard port
C	USB 2.0 ports
D	Serial port
E	Parallel port
F	VGA port
G	RJ-45 (optional)
H	USB 2.0 ports
I	Mic in
J	Audio line out
K	Audio line in

Figure 13. Back Panel Connectors

Replacing the Battery

A coin-cell battery (CR2032) powers the real-time clock and CMOS memory. When the computer is not plugged into a wall socket, the battery has an estimated life of three years. When the computer is plugged in, the standby current from the power supply extends the life of the battery. The clock is accurate to ± 13 minutes/year at 25 °C with 3.3 VSB applied.

When the voltage drops below a certain level, the BIOS Setup program settings stored in CMOS RAM (for example, the date and time) might not be accurate. Replace the battery with an equivalent one. Figure 14 shows the location of the battery.



CAUTION

Risk of explosion if the battery is replaced with an incorrect type. Batteries should be recycled where possible. Disposal of used batteries must be in accordance with local environmental regulations.



PRECAUTION

Risque d'explosion si la pile usagée est remplacée par une pile de type incorrect. Les piles usagées doivent être recyclées dans la mesure du possible. La mise au rebut des piles usagées doit respecter les réglementations locales en vigueur en matière de protection de l'environnement.



FORHOLDSREGEL

Eksplussionsfare, hvis batteriet erstattes med et batteri af en forkert type. Batterier bør om muligt genbruges. Bortskaffelse af brugte batterier bør foregå i overensstemmelse med gældende miljølovgivning.



OBS!

Det kan oppstå eksplosjonsfare hvis batteriet skiftes ut med feil type. Brukte batterier bør kastes i henhold til gjeldende miljølovgivning.



VIKTIGT!

Risk för explosion om batteriet ersätts med felaktig batterityp. Batterier ska kasseras enligt de lokala miljövårdsbestämmelserna.



VARO

Räjähdyksvaara, jos pariston tyyppi on väärä. Paristot on kierrätettävä, jos se on mahdollista. Käytetyt paristot on hävitettävä paikallisten ympäristömääräysten mukaisesti.



VORSICHT

Bei falschem Einsetzen einer neuen Batterie besteht Explosionsgefahr. Die Batterie darf nur durch denselben oder einen entsprechenden, vom Hersteller empfohlenen Batterietyp ersetzt werden. Entsorgen Sie verbrauchte Batterien den Anweisungen des Herstellers entsprechend.



AVVERTIMENTO

Esiste il pericolo di un esplosione se la pila non viene sostituita in modo corretto. Utilizzare solo pile uguali o di tipo equivalente a quelle consigliate dal produttore. Per disfarsi delle pile usate, seguire le istruzioni del produttore.



PRECAUCIÓN

Existe peligro de explosión si la pila no se cambia de forma adecuada. Utilice solamente pilas iguales o del mismo tipo que las recomendadas por el fabricante del equipo. Para deshacerse de las pilas usadas, siga igualmente las instrucciones del fabricante.



WAARSCHUWING

Er bestaat ontploffingsgevaar als de batterij wordt vervangen door een onjuist type batterij. Batterijen moeten zoveel mogelijk worden gerecycled. Houd u bij het weggooien van gebruikte batterijen aan de plaatselijke milieuwetgeving.



ATENÇÃO

Haverá risco de explosão se a bateria for substituída por um tipo de bateria incorreto. As baterias devem ser recicladas nos locais apropriados. A eliminação de baterias usadas deve ser feita de acordo com as regulamentações ambientais da região.



AŠCIAROŽNÁŠĆ

Існуе рызыка выбуху, калі заменены акумулятар непраўльнага тыпу. Акумулятары павінны, па магчымасці, перерацоўвацца. Пазбаўляцца ад старых акумулятараў патрэбна згодна з мясцовымі заканадаўствам па экалогіі.



UPOZORNĚNÍ

V případě výměny baterie za nesprávný druh může dojít k výbuchu. Je-li to možné, baterie by měly být recyklovány. Baterie je třeba zlikvidovat v souladu s místními předpisy o životním prostředí.



Προσοχή

Υπάρχει κίνδυνος για έκρηξη σε περίπτωση που η μπαταρία αντικατασταθεί από μία λανθασμένου τύπου. Οι μπαταρίες θα πρέπει να ανακυκλώνονται όταν κάτι τέτοιο είναι δυνατό. Η απόρριψη των χρησιμοποιημένων μπαταριών πρέπει να γίνεται σύμφωνα με τους κατά τόπο περιβαλλοντικούς κανονισμούς.



VIGYÁZAT

Ha a telepet nem a megfelelő típusú telepre cseréli, az felrobbanhat. A telepeket lehetőség szerint újra kell hasznosítani. A használt telepeket a helyi környezetvédelmi előírásoknak megfelelően kell kiselejtezni.



注意

異なる種類の電池を使用すると、爆発の危険があります。リサイクルが可能な地域であれば、電池をリサイクルしてください。使用後の電池を破棄する際には、地域の環境規制に従ってください。



AWAS

Risiko letupan wujud jika bateri digantikan dengan jenis yang tidak betul. Bateri sepatutnya dikitar semula jika boleh. Pelupusan bateri terpakai mestilah mematuhi peraturan alam sekitar tempatan.



OSTRZEŻENIE

Istnieje niebezpieczeństwo wybuchu w przypadku zastosowania niewłaściwego typu baterii. Zużyte baterie należy w miarę możliwości utylizować zgodnie z odpowiednimi przepisami ochrony środowiska.



PRECAUȚIE

Risc de explozie, dacă bateria este înlocuită cu un tip de baterie necorespunzător. Bateriile trebuie reciclate, dacă este posibil. Depozitarea bateriilor uzate trebuie să respecte reglementările locale privind protecția mediului.



ВНИМАНИЕ

При использовании батареи несоответствующего типа существует риск ее взрыва. Батареи должны быть утилизированы по возможности. Утилизация батарей должна проводиться по правилам, соответствующим местным требованиям.



UPOZORNENIE

Ak batériu vymeníte za nesprávny typ, hrozí nebezpečenstvo jej výbuchu. Batérie by sa mali podľa možnosti vždy recyklovať. Likvidácia použitých batérií sa musí vykonávať v súlade s miestnymi predpismi na ochranu životného prostredia.



POZOR

Zamenjava baterije z baterijo drugačnega tipa lahko povzroči eksplozijo. Če je mogoče, baterije reciklirajte. Rabljene baterije zavrzite v skladu z lokalnimi okoljevarstvenimi predpisi.



การระวัง

ระวังการระเบิดที่เกิดจากเปลี่ยนแบตเตอรี่ผิดประเภท หากเป็นไปได้ ควรนำแบตเตอรี่ไปรีไซเคิล การทิ้งแบตเตอรี่ใช้แล้วต้องเป็นไปตามกฎข้อบังคับด้านสิ่งแวดล้อมของท้องถิ่น.

**UYARI**

Yanlış türde pil takıldığında patlama riski vardır. Piller mümkün olduğunda geri dönüştürülmelidir. Kullanılmış piller, yerel çevre yasalarına uygun olarak atılmalıdır.

**ОСТОРОГА**

Використовуйте батареї правильного типу, інакше існуватиме ризик вибуху. Якщо можливо, використані батареї слід утилізувати. Утилізація використаних батарей має бути виконана згідно місцевих норм, що регулюють охорону довкілля.

To replace the battery, follow these steps:

1. Observe the precautions in “Before You Begin” on page 21.
2. Turn off all peripheral devices connected to the computer. Disconnect the computer’s power cord from the AC power source (wall outlet or power adapter).
3. Remove the computer cover.
4. Locate the battery on the board (see Figure 14).
5. Note the orientation of the “+” and “-” on the battery.
6. With a medium flat-bladed screwdriver, gently pry the battery free from its connector.
7. Install the new battery in the connector, orienting the “+” and “-” correctly.
8. Replace the computer cover.

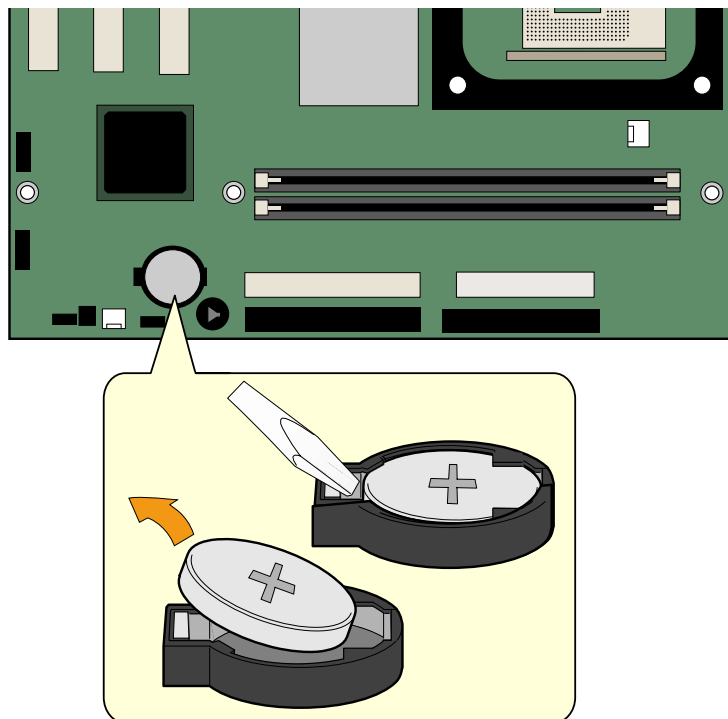

OM16284

Figure 14. Removing the Battery from the Desktop Board

3 Updating the BIOS

This chapter tells you how to update the BIOS by either using the Intel Express BIOS Update utility or the Intel® Flash Memory Update Utility, and how to recover the BIOS if an update fails.

Updating the BIOS with the Intel® Express BIOS Update Utility

With the Intel Express BIOS Update utility you can update the system BIOS while in the Windows environment. The BIOS file is included in an automated update utility that combines the functionality of the Intel Flash Memory Update Utility and the ease-of-use of Windows-based installation wizards.

To update the BIOS with the Intel Express BIOS Update utility:

1. Go to the Intel World Wide Web site:
<http://support.intel.com/support/motherboards/desktop/>
2. Navigate to the D845GVSR page, click “[view] Latest BIOS updates”, and select the Express BIOS Update utility file.
3. Download the file to your hard drive. (You can also save this file to a diskette. This is useful if you are updating the BIOS for multiple identical systems.)
4. Close all other applications. This step is required. Your system will be rebooted at the last Express BIOS Update window.
5. Double-click the executable file from the location on your hard drive where it was saved. This runs the update program.
6. Follow the instructions provided in the dialog boxes to complete the BIOS update.

Updating the BIOS with the Intel® Iflash BIOS Update Utility

With the Intel® Iflash BIOS update utility you can update the system BIOS from a floppy disk or other bootable media. The utility available from the Web provides a simple method for creating a bootable flash memory update floppy that will automatically update your BIOS.

Obtaining the BIOS Update File

You can update to a new version of the BIOS by using the BIOS update file. The BIOS update file is a compressed self-extracting archive that contains all the files you need to update the BIOS. The BIOS update file contains New BIOS files, BIOS recovery files, and the Intel Flash Memory Update utility.

You can obtain the BIOS update file through your computer supplier or by navigating to the D845GVSR page on the Intel World Wide Web site at:

<http://support.intel.com/support/motherboards/desktop/>

Navigate to the D845GVSR page, click “[view] Latest BIOS updates”, and select the Intel Iflash BIOS Update utility file.

 **NOTE**

Review the instructions distributed with the update utility before attempting a BIOS update.

The Intel Iflash BIOS update utility allows you to:

- Update the BIOS in flash memory
- Update the language section of the BIOS

Updating the BIOS

 **CAUTION**

The AUTOEXEC.BAT file provided with the update files updates the BIOS. Do not interrupt the process or the system may not function.

1. Boot the computer with the BIOS update diskette in drive A. During system boot, the AUTOEXEC.BAT file provided with the update files will automatically run the BIOS update process.
2. When the update process is complete, the monitor will display a message telling you to remove the diskette and to reboot the system.
3. As the computer boots, check the BIOS identifier (version number) to make sure the update was successful. If a logo appears, press <Esc> to view the POST messages.

Recovering the BIOS

It is unlikely that anything will interrupt the BIOS update, however, if an interruption occurs, the BIOS could be damaged. The following steps explain how to recover the BIOS if an update fails. The following procedure uses recovery mode for the Setup program. See page 37 for more information on Setup modes.

 **NOTE**

Because of the small amount of code available in the boot block area, there is no video support. You will not see anything on the screen during this procedure. Monitor the procedure by listening to the speaker and looking at the diskette drive LED.

1. Turn off the computer, disconnect the computer's power cord, and disconnect all external peripherals.
2. Remove the computer cover and locate the configuration jumper block (J9H2) (see Figure 12).
3. Remove the jumper from all pins as shown below to set recovery mode for Setup.



4. Insert the bootable BIOS update diskette into diskette drive A.
5. Replace the computer cover, connect the power cord, turn on the computer, and allow it to boot. The recovery process will take a few minutes.

6. Listen to the speaker:
 - Upon applying power, drive A will begin to show activity. In about a minute, two beeps are heard and drive A activity ceases (temporarily) indicating the successful recovery of the BIOS core. Drive A activity will begin again followed by two more beeps indicating the successful recovery of the boot block. This sequence of events indicates a successful BIOS recovery.
 - A series of continuous beeps indicates a failed BIOS recovery.
7. If recovery fails, return to step 1 and repeat the recovery process.
8. If recovery is successful, turn off the computer, and disconnect its power cord.
9. Remove the computer cover and continue with the following steps.
10. On the jumper block (J9H2), reinstall the jumper back on pins 1-2 as shown below to set normal mode for Setup.



11. Leave the update diskette in drive A, replace the computer cover, and connect the computer's power cord.
12. Turn on the computer and continue with the BIOS update (see page 46).

4 Using the BIOS Setup Program

The BIOS Setup program can be used to view and change the BIOS settings for the computer. The BIOS Setup program is accessed by pressing the <F2> key after the Power-On Self-Test (POST) memory test begins and before the operating system boot begins.

 **NOTE**

The BIOS Setup menus described in this section may not show the latest settings. For the latest BIOS settings, refer to the Intel Desktop Board D845GVSR Technical Product Specification or the Intel World Wide Web site at:

<http://support.intel.com/support/motherboards/desktop/>

 **NOTE**

For reference purposes, you should write down the current Setup settings. When you make changes to the settings, update this record.

 **NOTE**

The Setup menus described in this section apply to the desktop board with BIOS identifier VA84510A.86A. Desktop boards with other BIOS identifiers might have differences in some of the Setup menu screens.

Table 10 shows the BIOS Setup program menu bar.

Table 10. BIOS Setup Program Menu Bar

Maintenance	Main	Advanced	Security	Power	Boot	Exit
Clears passwords and Boot Integrity Service (BIS)* credentials, and configures extended configuration memory settings	Allocates resources for hardware components	Configures advanced features available through the chipset	Sets passwords and security features	Configures power management features	Selects boot options and power supply controls	Saves or discards changes to set program options

* For information about the BIS, refer to the Intel Web site at:

<http://developer.intel.com/design/security/index1.htm>

Table 11 shows the function keys available for menu screens.

Table 11. BIOS Setup Program Function Keys

BIOS Setup Program Function Key	Description
<<-> or <->>	Selects a different menu screen
<↑> or <↓>	Moves cursor up or down
<Tab>	Moves cursor to the next field
<Enter>	Executes command or selects the submenu
<F9>	Load the default configuration values for the current menu
<F10>	Save the current values and exits the BIOS Setup program
<Esc>	Exits the menu

Maintenance Menu

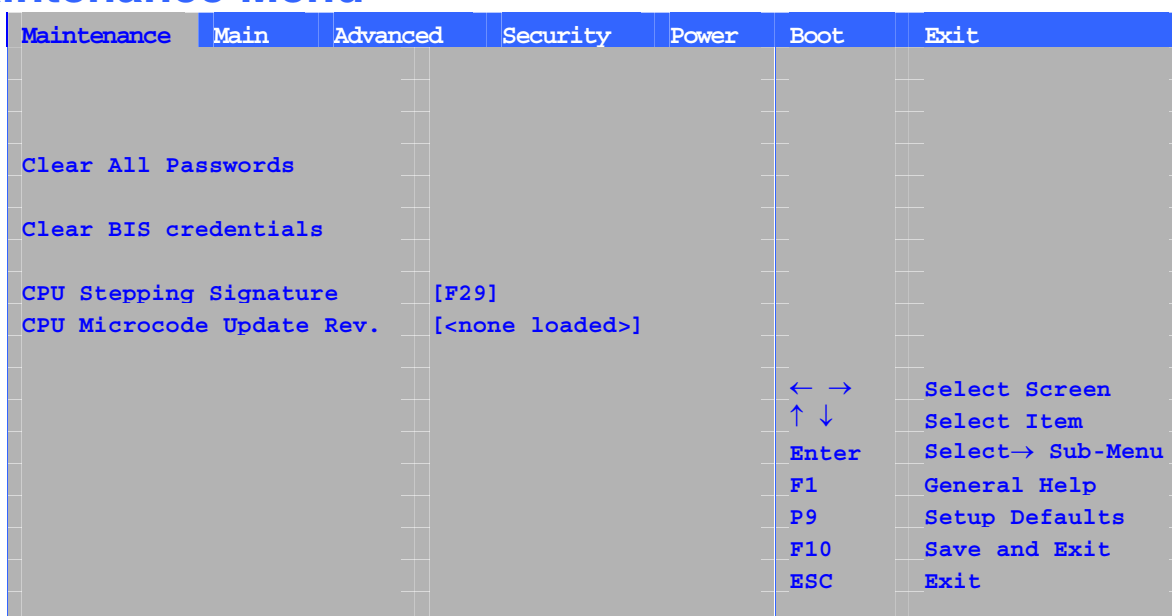

The menu shown in Table 12 is used to clear the Setup passwords. Setup only displays this menu in configure mode. See page 37 for information about setting configure mode.

Table 12. Maintenance Menu

Feature	Options	Description
Clear All Passwords	<ul style="list-style-type: none"> • Ok • Cancel 	Clears both the user and supervisor passwords.
Clear BIS Credentials	<ul style="list-style-type: none"> • Ok • Cancel 	Clears the Wired for Management Boot Integrity Service (BIS) credentials.
CPU Stepping Signature	No options	Displays processor's Stepping Signature.
CPU Microcode Update Revision	No options	Displays processor's Microcode Update Revision.

* For information about the BIS, refer to the Intel Web site at:

<http://developer.intel.com/design/security/index1.htm>

Main Menu

Maintenance	Main	Advanced	Security	Power	Boot	Exit
BIOS Version			VA84510A.86A.xxxx.xxx			
Processor Type			Intel(R) XXXXXXXXXXXX			
Processor Speed			X.XX GHz			
System Bus Speed			XXX MHz			
System Memory Speed			XXX MHz			
Cache RAM			XXX KB			
Total Memory			XXX MB			
Memory Bank 0			XXX MB			
Memory Bank 1			XXX MB			
Language			[English]			← → Select Screen
System Time			[HH.MM.SS]			↑ ↓ Select Item
System Date			[DD.MM.YY]			Enter Select ► Sub-Menu
						F1 General Help
						P9 Setup Defaults
						F10 Save and Exit
						ESC Exit

Main menu reports processor and memory information and is used to configure the system date and system time. Table 13 describes this menu.

Table 13. Main Menu

Feature	Options	Description
BIOS Version	No options	Displays the version of the BIOS.
Processor Type	No options	Displays processor type.
Hyper-Threading Technology	<ul style="list-style-type: none"> • Enabled (default) • Disabled 	Enables or disables Hyper-Threading Technology.
Processor Speed	No options	Displays processor speed.
System Bus Speed	No options	Displays the system bus speed.
System Memory Speed	No options	Displays the system memory speed.
Cache RAM	No options	Displays the size of second-level cache and whether it is ECC-capable.
Total Memory	No options	Displays the total amount of RAM.
Memory Bank 0 Memory Bank 1	No options	Displays the amount and type of RAM in the memory banks.
Language	<ul style="list-style-type: none"> • English (default) • Espanol 	Selects the current default language used by the BIOS.
System Time	Hour, minute, and second	Specifies the current time.
System Date	Day of week - month/day/year	Specifies the current date.

Advanced Menu

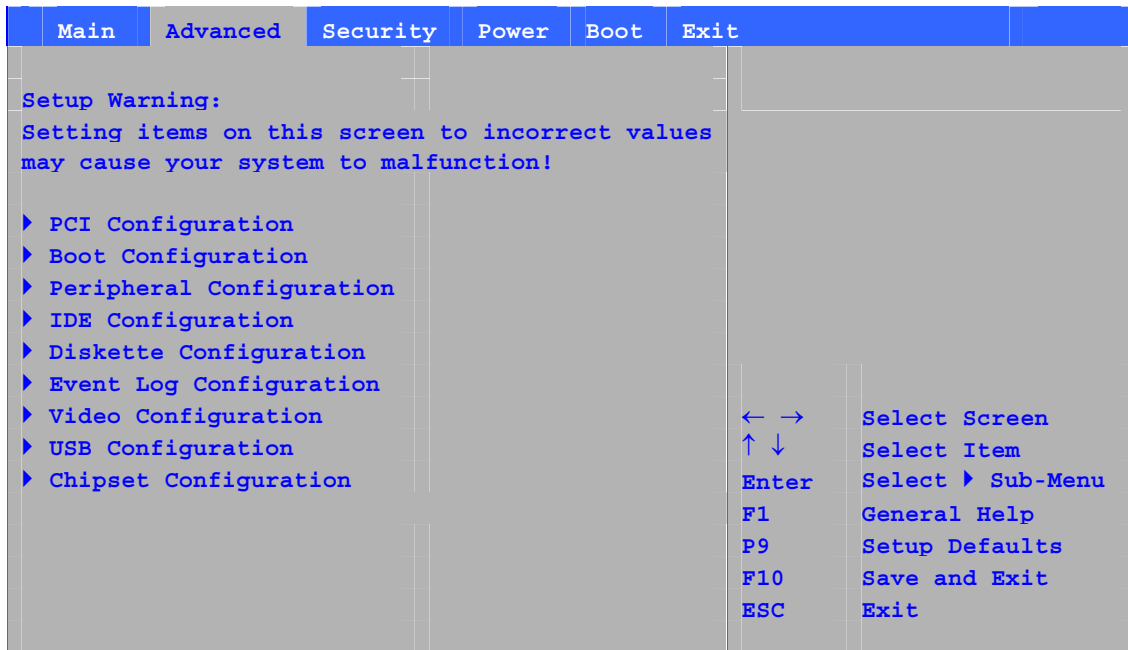
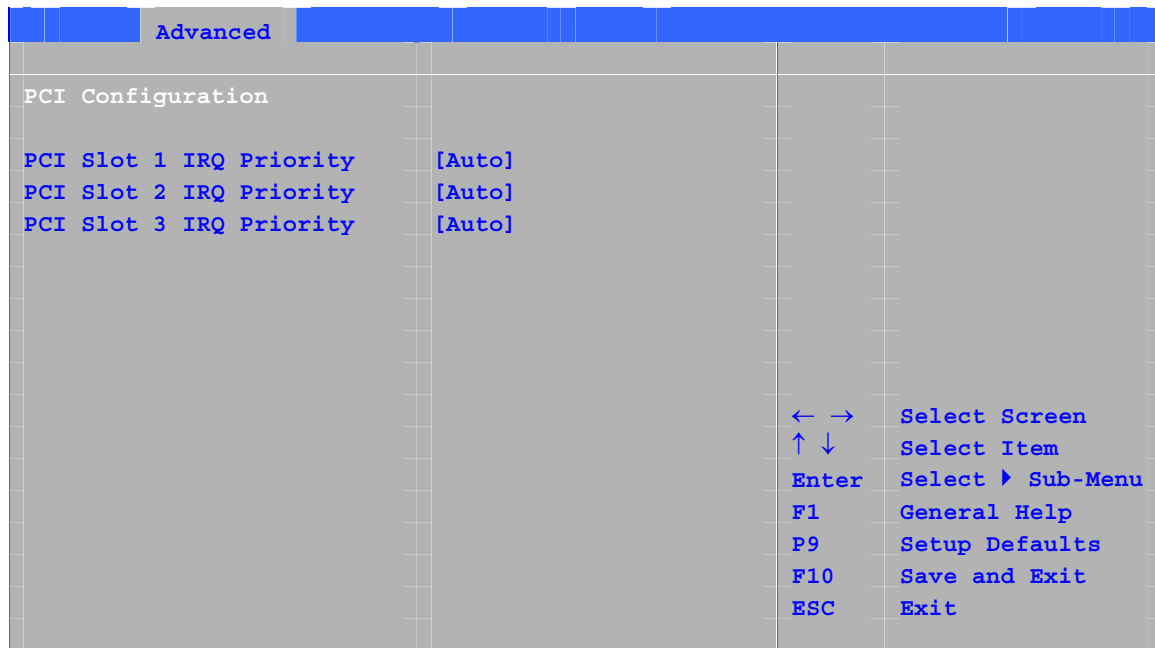

Table 14 describes the Advanced Menu. This menu is used to set advanced features that are available through the chipset.

Table 14. Advanced Menu

Feature	Options	Description
PCI Configuration	No options	Configures individual PCI slot's IRQ priority. When selected, displays the PCI Configuration submenu.
Boot Configuration	No options	Configures Plug & Play and the Numlock key, and resets configuration data. When selected, displays the Boot Configuration submenu.
Peripheral Configuration	No options	Configures peripheral ports and devices. When selected, displays the Peripheral Configuration submenu.
IDE Configuration	No options	Specifies type of connected IDE device.
Diskette Configuration	No options	Configures the floppy drive(s). When selected, displays the Diskette Configuration submenu.
Event Log Configuration	No options	Configures event logging. When selected, displays the Event Log Configuration submenu.
Video Configuration	No options	Configures video features. When selected, displays the Video Configuration submenu.
USB Configuration	No options	Configures USB features. When selected, displays the USB Configuration submenu.
Chipset Configuration	No options	Configures chipset features. When selected, displays the Chipset Configuration submenu.

PCI Configuration Submenu



The submenu shown in Table 15 is used to configure the IRQ priority of PCI slots individually.

Table 15. PCI Configuration Submenu

Feature	Options	Description
PCI Slot 1 IRQ Priority	<ul style="list-style-type: none"> • Auto (default) • 3 • 5 • 9 • 10 • 11 	Allows selection of IRQ priority.
PCI Slot 2 IRQ Priority	<ul style="list-style-type: none"> • Auto (default) • 3 • 5 • 9 • 10 • 11 	Allows selection of IRQ priority and S5 wake.
PCI Slot 3 IRQ Priority	<ul style="list-style-type: none"> • Auto (default) • 3 • 5 • 9 • 10 • 11 	Allows selection of IRQ priority.

Boot Configuration Submenu

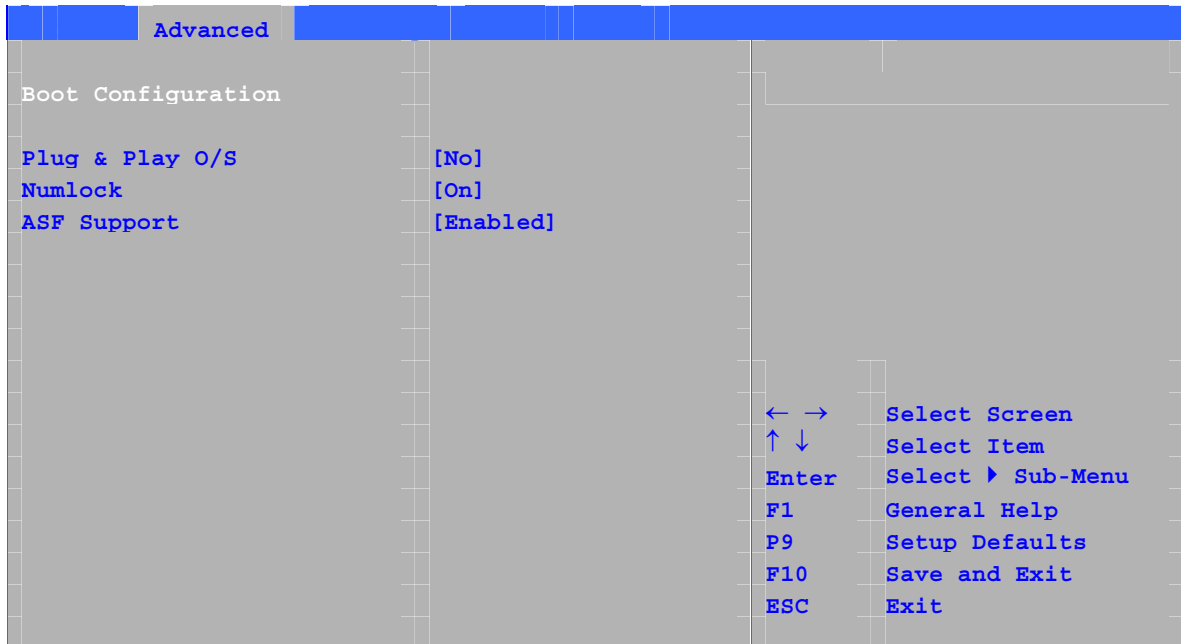

The submenu shown in Table 16 is used to set the Plug & Play options and the power-on state of the Numlock key.

Table 16. Boot Configuration Submenu

Feature	Options	Description
Plug & Play O/S	<ul style="list-style-type: none"> • No (default) • Yes 	<p>Specifies if manual configuration is desired.</p> <p><i>No</i> lets the BIOS configure all devices in the system. This setting is appropriate when using a Plug and Play operating system.</p> <p><i>Yes</i> lets the operating system configure Plug & Play (PnP) devices not required for boot if your system has a Plug & Play operating system. This option is available for use during lab testing.</p>
Numlock	<ul style="list-style-type: none"> • Off • On (default) 	<p>Specifies the power-on state of the Numlock feature on the numeric keypad of the keyboard.</p>
ASF Support	<ul style="list-style-type: none"> • Enabled (default) • Disabled 	<p>Configures LAN ASF (Alert Standard Format).</p>

Peripheral Configuration Submenu

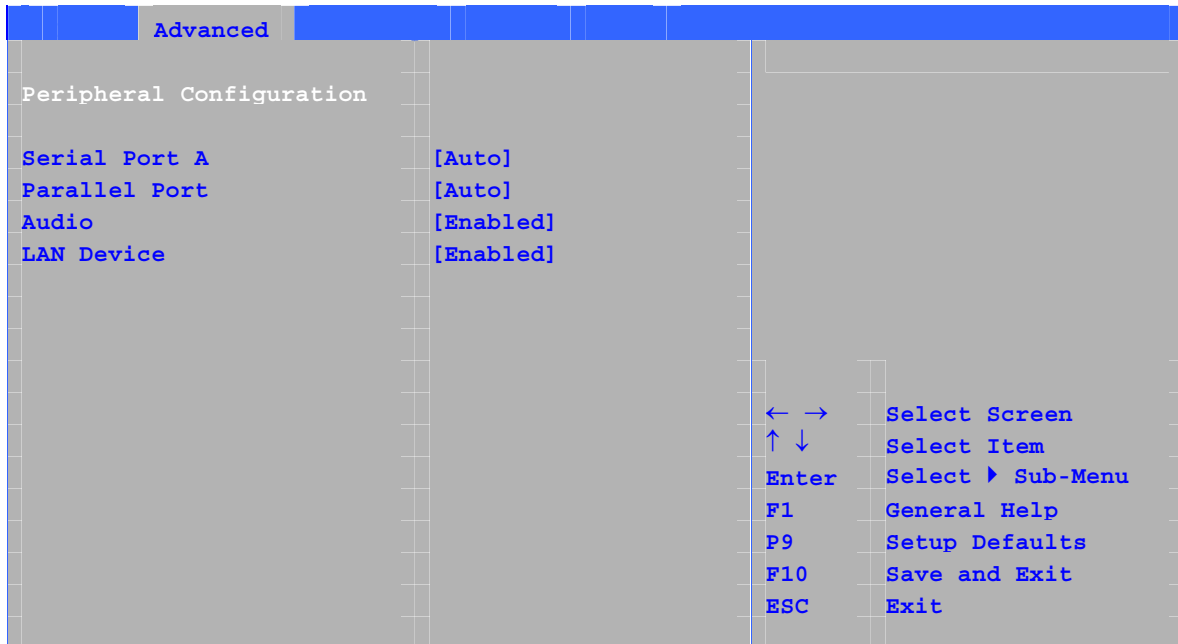

This submenu shown in Table 17 is used for configuring computer peripherals.

Table 17. Peripheral Configuration Submenu

Feature	Options	Description
Serial Port A	<ul style="list-style-type: none"> Disabled Enabled Auto (default) 	Configures serial port A. <i>Auto</i> assigns the first free COM port, normally COM1, the address 3F8h, and the interrupt IRQ4. An * (asterisk) displayed next to an address indicates a conflict with another device.
Base I/O Address (This feature is present only when Serial Port A is set to <i>Enabled</i>)	<ul style="list-style-type: none"> 3F8 (default) 2F8 3E8 2E8 	Specifies the base I/O address for serial port A, if serial port A is Enabled.
Interrupt (This feature is present only when Serial Port A is set to <i>Enabled</i>)	<ul style="list-style-type: none"> IRQ 3 IRQ 4 (default) 	Specifies the interrupt for serial port A, if serial port A is Enabled.
Parallel Port	<ul style="list-style-type: none"> Disabled Enabled Auto (default) 	Configures the parallel port. <i>Auto</i> assigns LPT1 the address 378h and the interrupt IRQ7. An * (asterisk) displayed next to an address indicates a conflict with another device.

continued

Table 17. Peripheral Configuration Submenu (continued)

Feature	Options	Description
Mode	<ul style="list-style-type: none"> • Output only • Bi-directional (default) • EPP • ECP 	<p>Selects the mode for the parallel port. Not available if the parallel port is disabled.</p> <p><i>Output Only</i> operates in AT*-compatible mode.</p> <p><i>Bi-directional</i> operates in PS/2-compatible mode.</p> <p><i>EPP</i> is Extended Parallel Port mode, a high-speed bi-directional mode.</p> <p><i>ECP</i> is Enhanced Capabilities Port mode, a high-speed bi-directional mode.</p>
Base I/O Address (This feature is present only when Parallel Port is set to <i>Enabled</i>)	<ul style="list-style-type: none"> • 378 (default) • 278 	Specifies the base I/O address for the parallel port, if Parallel Port is Enabled.
Interrupt (This feature is present only when Parallel Port is set to <i>Enabled</i>)	<ul style="list-style-type: none"> • IRQ 5 • IRQ 7 (default) 	Specifies the interrupt for the parallel port, if Parallel Port is Enabled.
Audio	<ul style="list-style-type: none"> • Disabled • Enabled (default) 	Enables or disables the onboard audio subsystem.
LAN Device (This feature is present only when there is onboard LAN)	<ul style="list-style-type: none"> • Disabled • Enabled (default) 	Enables or disables the LAN device.

IDE Configuration Submenu

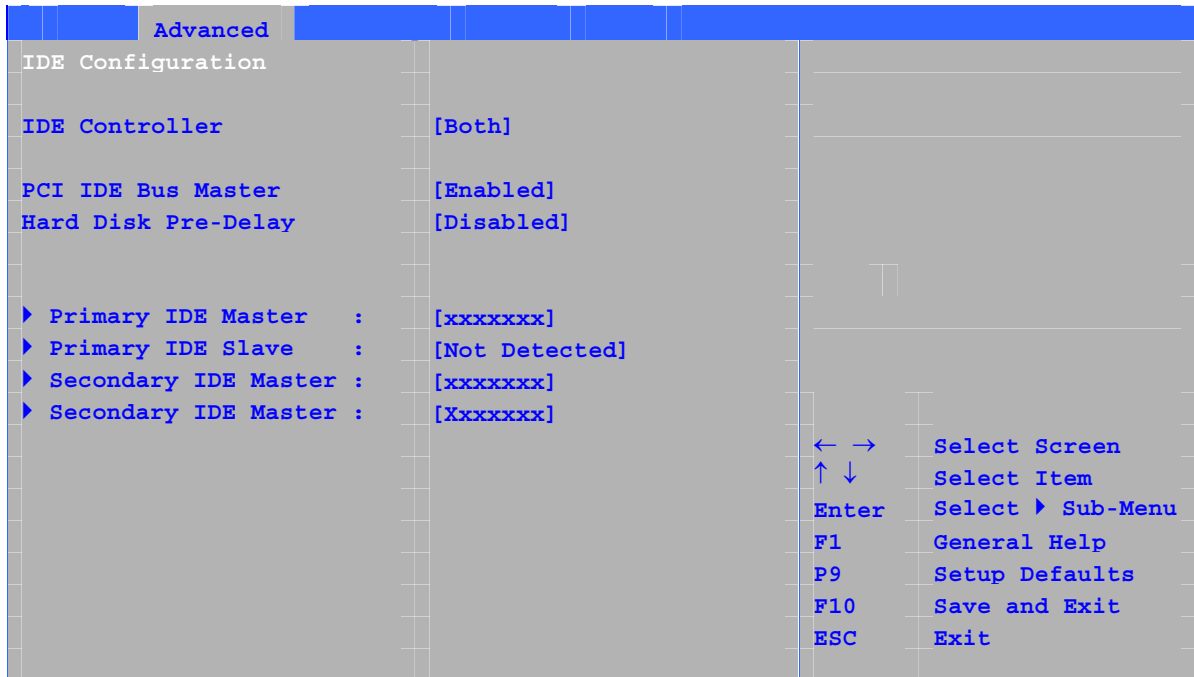

This submenu shown in Table 18 is used to configure IDE device options.

Table 18. IDE Configuration Submenu

Feature	Options	Description
IDE Controller	<ul style="list-style-type: none"> • Disabled • Primary • Secondary • Both (default) 	Specifies the integrated IDE controller. <i>Disabled</i> disables the integrated IDE controller. <i>Primary</i> enables only the primary IDE controller. <i>Secondary</i> enables only the secondary IDE controller. <i>Both</i> enables both IDE controllers.
PCI IDE Bus Master	<ul style="list-style-type: none"> • Disabled • Enabled (default) 	Allows for a PCI device to initiate a transaction as a master.
Hard Disk Pre-Delay	<ul style="list-style-type: none"> • Disabled (default) • 3 Seconds • 6 Seconds • 9 Seconds • 12 Seconds • 15 Seconds • 21 Seconds • 30 Seconds 	Specifies the hard disk drive pre-delay. Causes the BIOS to insert a delay before attempting to detect IDE drives in the system.
Primary IDE Master	No options	Reports type of connected IDE device. When selected, displays the Primary IDE Master submenu.
Primary IDE Slave	No options	Reports type of connected IDE device. When selected, displays the Primary IDE Slave submenu.
Secondary IDE Master	No options	Reports type of connected IDE device. When selected, displays the Secondary IDE Master submenu.
Secondary IDE Slave	No options	Reports type of connected IDE device. When selected, displays the Secondary IDE Slave submenu.

Primary/Secondary IDE Master/Slave Submenus

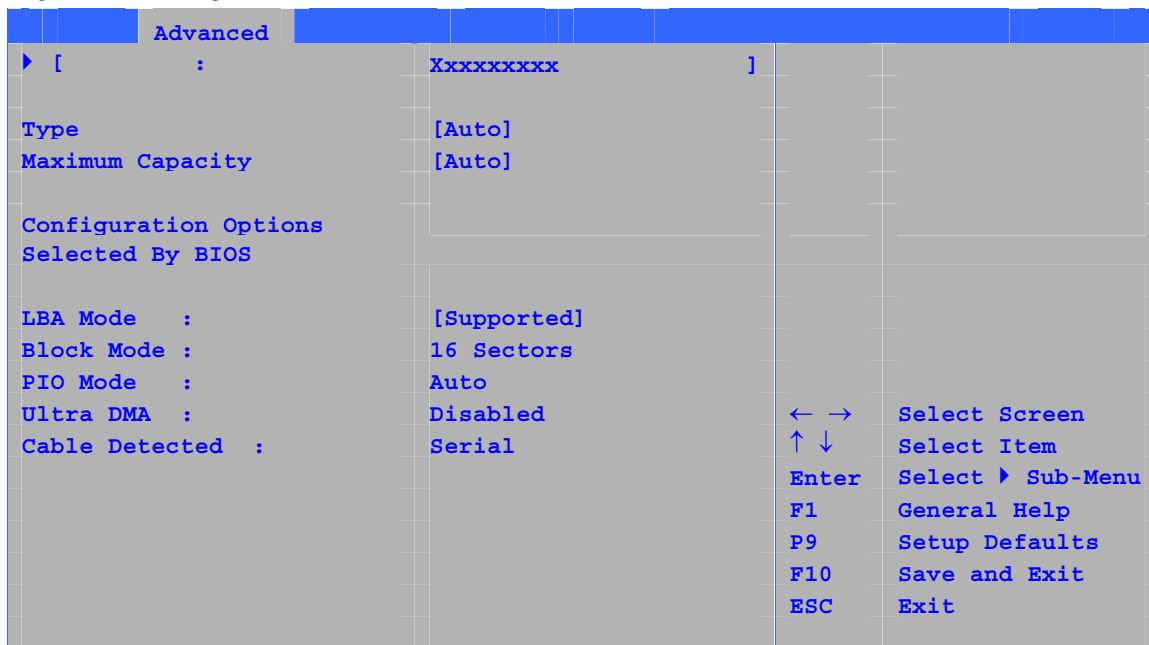

There are four IDE submenus: Primary master, primary slave, secondary master, and secondary slave. Table 19 shows the format of these IDE submenus. For brevity, only one example is shown.

Table 19. Primary/Secondary IDE Master/Slave Submenus

Feature	Options	Description
Drive Installed	<ul style="list-style-type: none"> None 	Displays the type of drive installed.
Type	<ul style="list-style-type: none"> Auto (default) User 	Specifies the IDE configuration mode for IDE devices. <i>Auto</i> fills-in capabilities from ATA/ATAPI device. <i>User</i> allows capabilities to be changed.
Maximum Capacity	<ul style="list-style-type: none"> None 	Displays the capacity of the drive.
LBA Mode Control (Note)	<ul style="list-style-type: none"> None 	Specifies LBA mode control.
Block Mode	<ul style="list-style-type: none"> Disabled Auto (default) 	Check the hard disk drive's specifications for optimum setting.
PIO Mode (Note)	<ul style="list-style-type: none"> Auto (default) 0 1 2 3 4 	Specifies the PIO mode.

continued

Table 19. Primary/Secondary IDE Master/Slave Submenus (continued)

Feature	Options	Description
Ultra DMA	<ul style="list-style-type: none">• Disabled (default)• Mode 0• Mode 1• Mode 2• Mode 3• Mode 4• Mode 5	Specifies the Ultra DMA mode for the drive.
Cable Detected (Note)	None	Displays the type of cable connected to the IDE interface: 40-conductor or 80-conductor (for ATA-66/100 devices).

Note: These configuration options appear only if an IDE device is installed.

Diskette Configuration Submenu

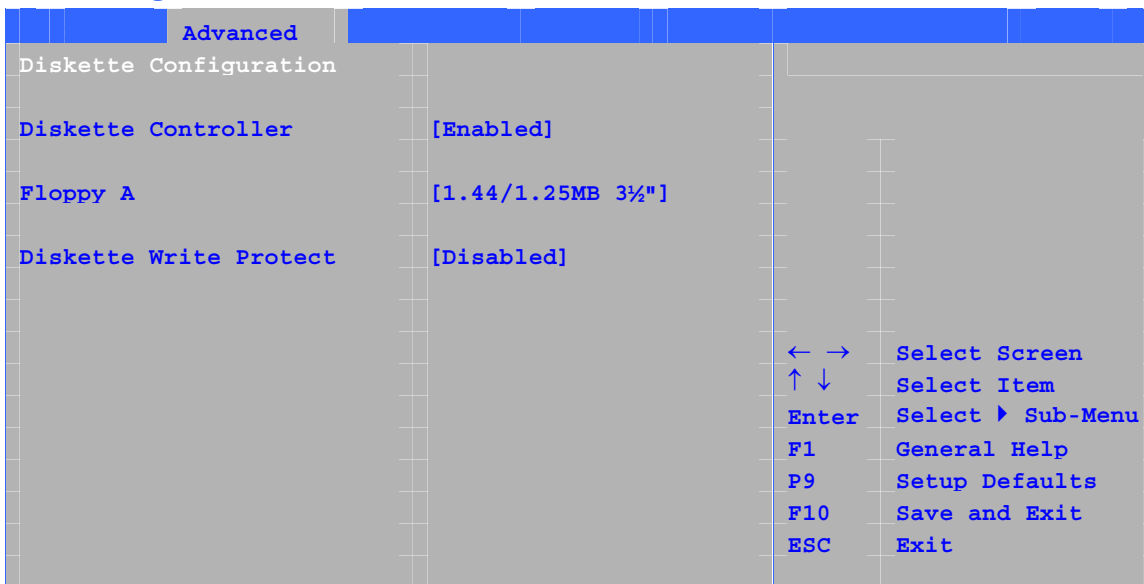

This submenu shown in Table 20 is used to configure the diskette drive.

Table 20. Diskette Configuration Submenu

Feature	Options	Description
Diskette Controller	<ul style="list-style-type: none"> Disabled Enabled (default) 	Configures the integrated diskette controller.
Floppy A	<ul style="list-style-type: none"> Disabled 360 KB 5¼" 1.2 MB 5¼" 720 KB 3½" 1.44 MB 3½" (default) 2.88 MB 3½" 	Selects the diskette drive type.
Diskette Write Protect	<ul style="list-style-type: none"> Disabled (default) Enabled 	Disables or enables diskette drive write protection.

Event Log Configuration Submenu

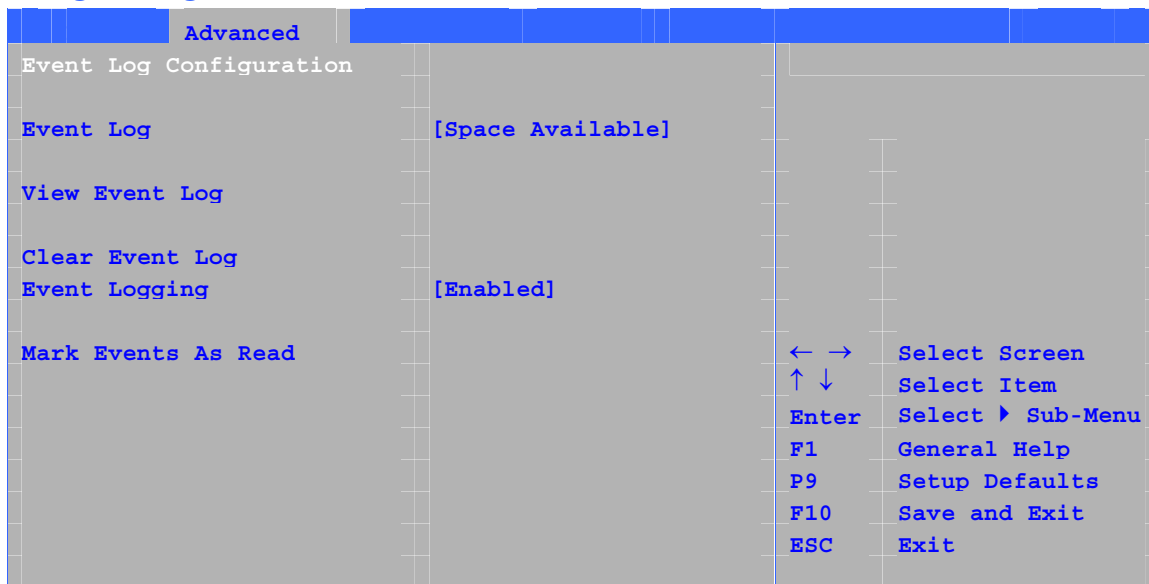

The submenu shown in Table 21 is used to configure the event logging features.

Table 21. Event Log Configuration Submenu

Feature	Options	Description
Event Log	No options	Indicates if there is space available in the event log.
View Event Log	[Enter]	Views the contents of the DMI event log.
Clear Event Log	No options	Discards all events in the event log.
Event Logging	<ul style="list-style-type: none"> • Disabled • Enabled (default) 	<i>Enabled</i> allows logging of DMI events.
Mark Events As Read	[Enter]	Marks all DMI events in the event log as read.

Video Configuration Submenu

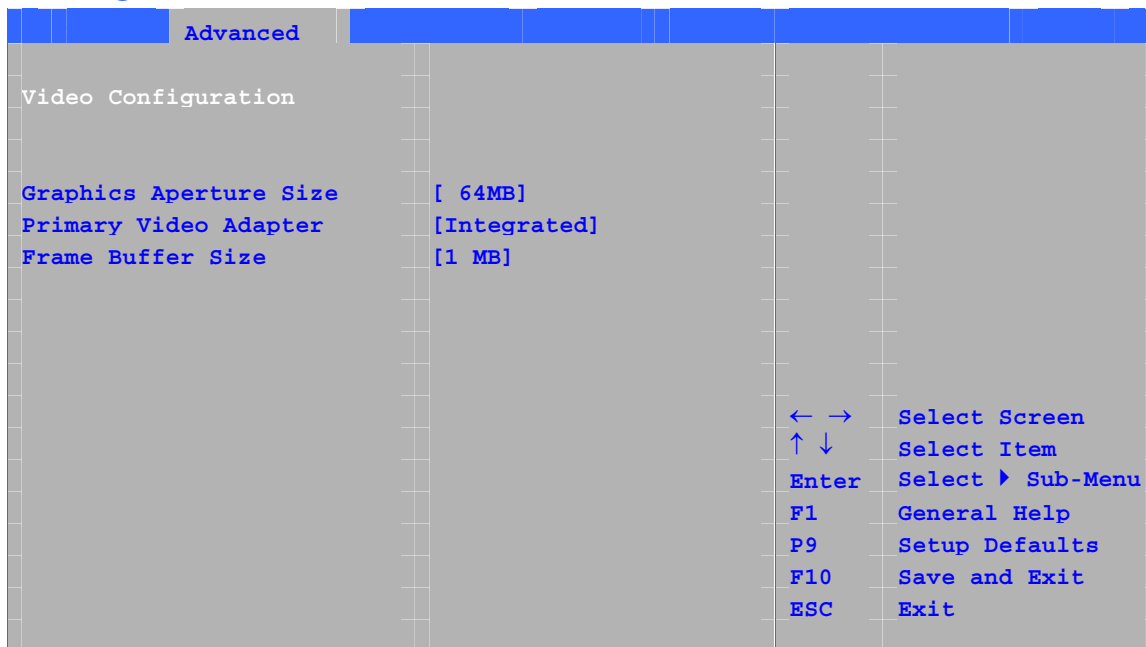

The submenu shown in Table 22 is used to configure video features.

Table 22. Video Configuration Submenu

Feature	Options	Description
Graphics Aperture Size	<ul style="list-style-type: none"> • 4 MB • 8 MB • 16 MB • 32 MB • 64 MB (default) • 128 MB • 256 MB 	Amount of system memory available for direct access by the graphics device.
Primary Video Adapter	<ul style="list-style-type: none"> • PCI • Integrated (default) 	Allows selecting the PCI video controller as the display device that will be active when the system boots.
Frame Buffer Size	<ul style="list-style-type: none"> • 512 KB • 1 MB (default) • 8 MB 	Controls how much RAM is reserved for use by the internal graphics device.

USB Configuration Submenu

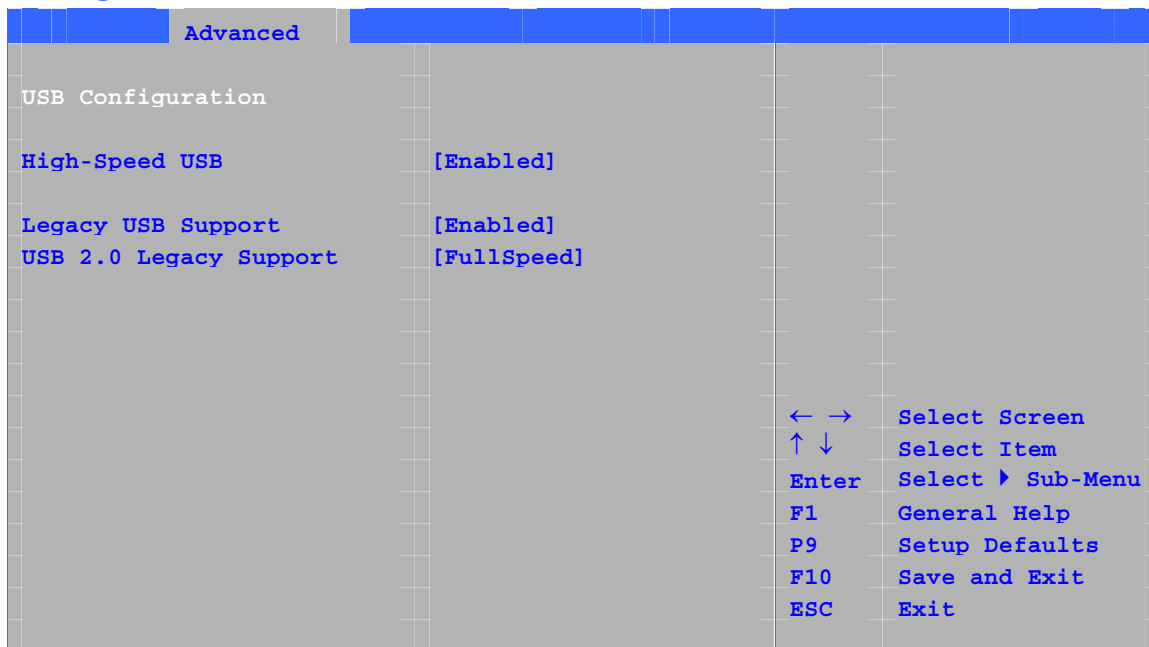

The menu shown in Table 23 is used to configure USB features.

Table 23. USB Configuration Submenu

Feature	Options	Description
High Speed USB	<ul style="list-style-type: none"> Disabled Enabled (default) 	Disable this option when a USB 2.0 driver is not available.
Legacy USB Support	<ul style="list-style-type: none"> Disabled Enabled (default) 	Enables support for legacy USB.
USB 2.0 Legacy Support	<ul style="list-style-type: none"> Full Speed (default) Hi Speed 	Configures Legacy USB transfer rate: Full Speed: 12 Mbps Hi Speed: 480 Mbps

Chipset Configuration Submenu

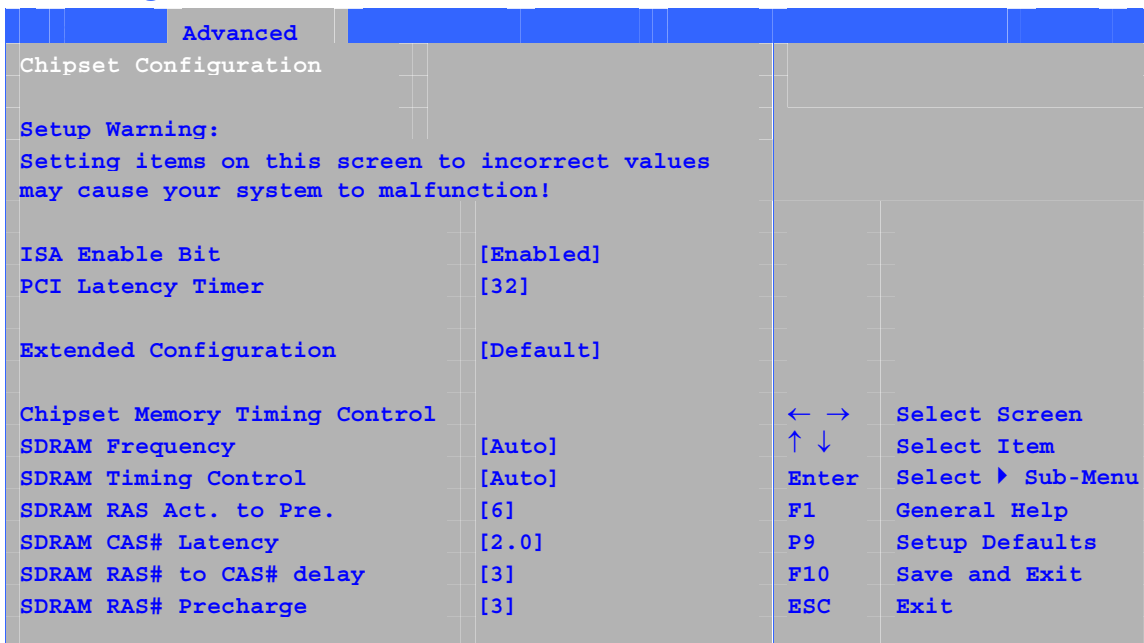

The menu shown in Table 24 is used to configure advanced chipset features.

Table 24. Chipset Configuration Submenu

Feature	Options	Description
ISA Enable Bit	<ul style="list-style-type: none"> • Enabled (default) • Disabled 	Some older expansion devices require this to be enabled.
PCI Latency Timer	<ul style="list-style-type: none"> • 32 (default) • 64 • 96 • 128 • 160 • 192 • 224 • 248 	Set PCI latency time.
Extended Configuration	<ul style="list-style-type: none"> • Default (default) • User Defined 	Chooses the default or user defined settings for the extended configuration options.
SDRAM Frequency	<ul style="list-style-type: none"> • Auto (default) • 200 MHz • 266 MHz 	Allows override of detected memory frequency value.

continued

Table 24. Chipset Configuration Submenu (continued)

Feature	Options	Description
SDRAM Timing Control	<ul style="list-style-type: none"> • Auto (default) • Manual – Aggressive • Manual – User Defined 	<p><i>Auto</i> allows timings to be programmed according to the memory detected.</p> <p><i>Manual – Aggressive</i> selects the most aggressive user defined timings.</p> <p><i>Manual – User Defined</i> allows manual override of detected SDRAM settings.</p>
SDRAM RAS Act. To Pre.	<ul style="list-style-type: none"> • 7 • 6 • 5 • Auto (default) 	Selects length of time from read to pre-change.
SDRAM CAS# Latency	<ul style="list-style-type: none"> • 3 • 2 • Auto (default) 	Selects the number of clock cycles required to address a column in memory.
SDRAM RAS# to CAS# delay	<ul style="list-style-type: none"> • 3 • 2 • Auto (default) 	Selects the number of clock cycles between addressing a row and addressing a column.
SDRAM RAS# Precharge	<ul style="list-style-type: none"> • 3 • 2 • Auto (default) 	Selects the length of time required before accessing a new row.

Security Menu

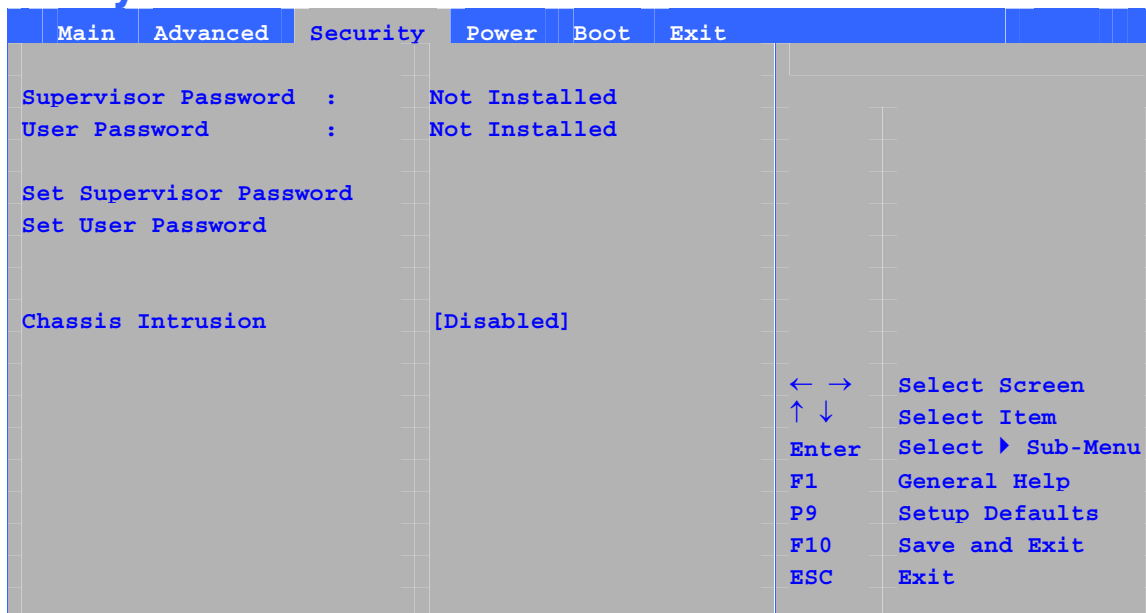

The menu shown in Table 25 is used to set passwords and security features.

Table 25. Security Menu

If no password entered previously:		
Feature	Options	Description
Supervisor Password	No options	Reports if there is a supervisor password set.
User Password	No options	Reports if there is a user password set.
Set Supervisor Password	Password can be up to seven alphanumeric characters.	Specifies the supervisor password.
Set User Password	Password can be up to seven alphanumeric characters.	Specifies the user password.
Clear User Password (Note 1)	<ul style="list-style-type: none"> • Yes (default) • No 	Clears the user password.
User access Level (Note 2)	<ul style="list-style-type: none"> • Limited • No access • View Only • Full (default) 	Sets BIOS Setup Utility access rights for user level.
Chassis Intrusion	<ul style="list-style-type: none"> • Disabled (default) • Enabled 	Enables and disables the chassis intrusion feature.

Notes:

1. This feature appears only if a user password has been set.
2. This feature appears only if both a user password and a supervisor password have been set.

Power Menu

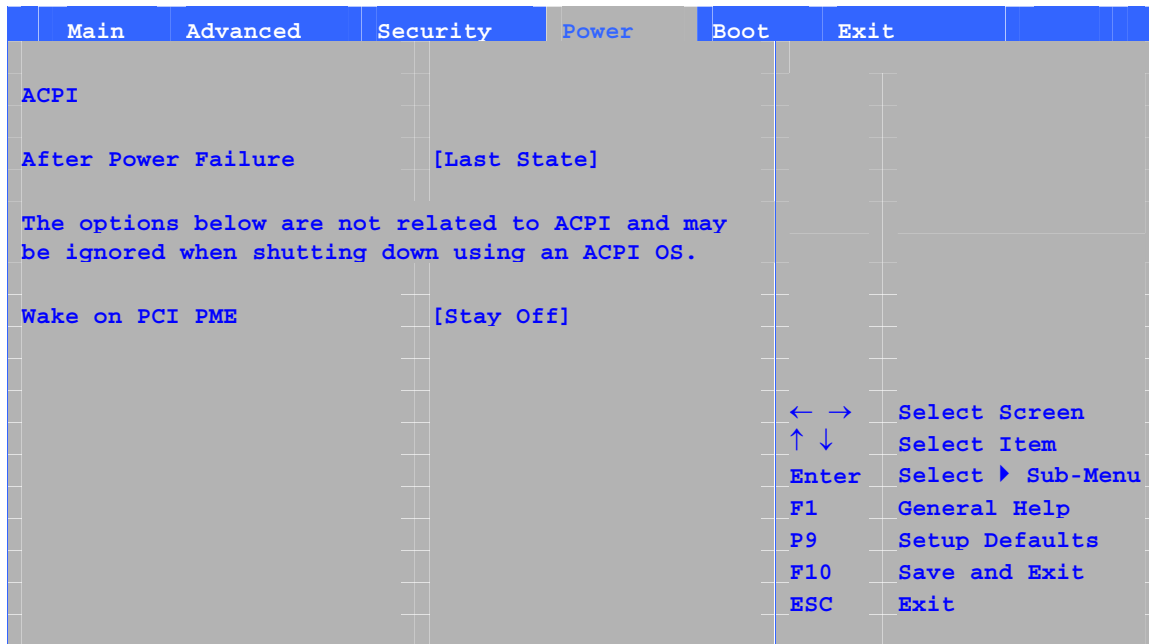

The menu shown in Table 26 is used to set power management features.

Table 26. Power Menu

Feature	Options	Description
ACPI	No Options	When selected, displays the ACPI submenu.
After Power Failure	<ul style="list-style-type: none"> Stay Off Last State (default) Power On 	<p>Determines the mode of operation if a power loss occurs.</p> <p><i>Stay Off</i> keeps the power off until the power button is pressed.</p> <p><i>Last State</i> restores the previous power state before power loss occurred.</p> <p><i>Power On</i> restores power to the computer.</p>
Wake on PCI PME	<ul style="list-style-type: none"> Stay Off (default) Power-On 	Determines how the system responds to a PCI-PME wake up event.

ACPI Submenu

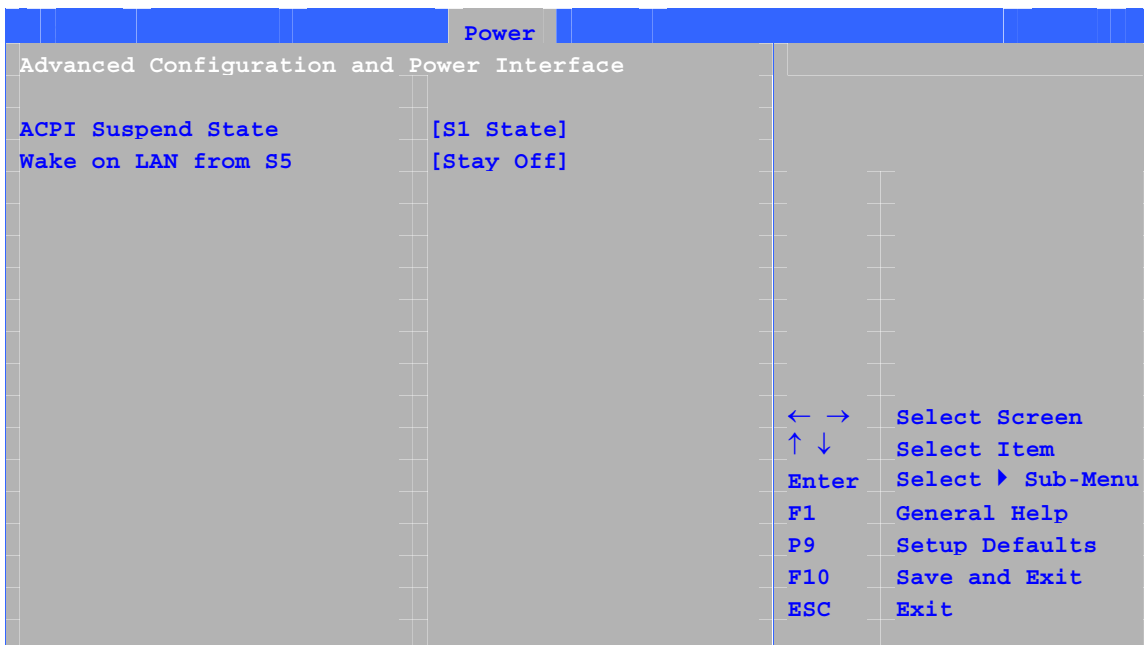

The submenu represented in Table 27 is for setting the ACPI features.

Table 27. ACPI Submenu

Feature	Options	Description
ACPI Suspend Mode	<ul style="list-style-type: none"> • S1 (POS) only (default) • S1 & S3 (STR) 	Specifies the ACPI sleep state.
Wake on LAN* from S5	<ul style="list-style-type: none"> • Stay Off (default) • Power On 	In ACPI soft-off mode only, determines how the system responds to a LAN wake up event when the system is in the ACPI soft-off mode.

Boot Menu

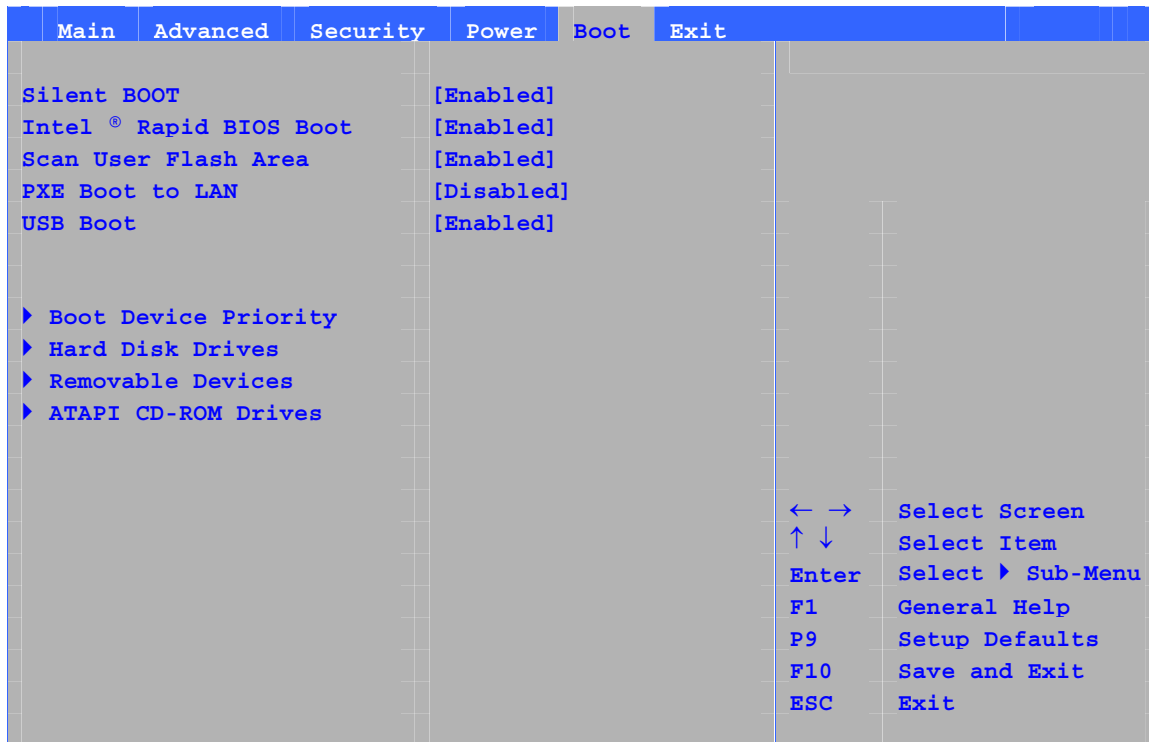

The menu shown in Table 28 is used to set the boot features and the boot sequence.

Table 28. Boot Menu

Feature	Options	Description
Silent Boot	<ul style="list-style-type: none"> Disabled Enabled (default) 	<p><i>Disabled</i> displays normal POST messages.</p> <p><i>Enabled</i> displays OEM logo instead of POST messages.</p>
Intel Rapid BIOS Boot	<ul style="list-style-type: none"> Disabled Enabled (default) 	Allows BIOS to skip certain tests while booting.
Scan User Flash Area	<ul style="list-style-type: none"> Disabled Enabled (default) 	Enables the BIOS to scan the flash ROM for user binary files that are executed at boot time.
PXE Boot to LAN	<ul style="list-style-type: none"> Disabled (default) Enabled 	Disables or enables PXE boot to LAN.
USB Boot	<ul style="list-style-type: none"> Disabled Enabled (default) 	Disables or enables booting to USB boot devices.
Boot Device Priority	No options	Specifies the boot sequence from the available types of boot devices.
Hard Disk Drives	No options	Specifies the boot sequence from the available hard disk drives.
Removable Devices	No options	Specifies the boot sequence from the available removable devices.
ATAPI CD-ROM Drives	No options	Specifies the boot sequence from the available ATAPI CD-ROM drives.

Boot Device Priority Submenu

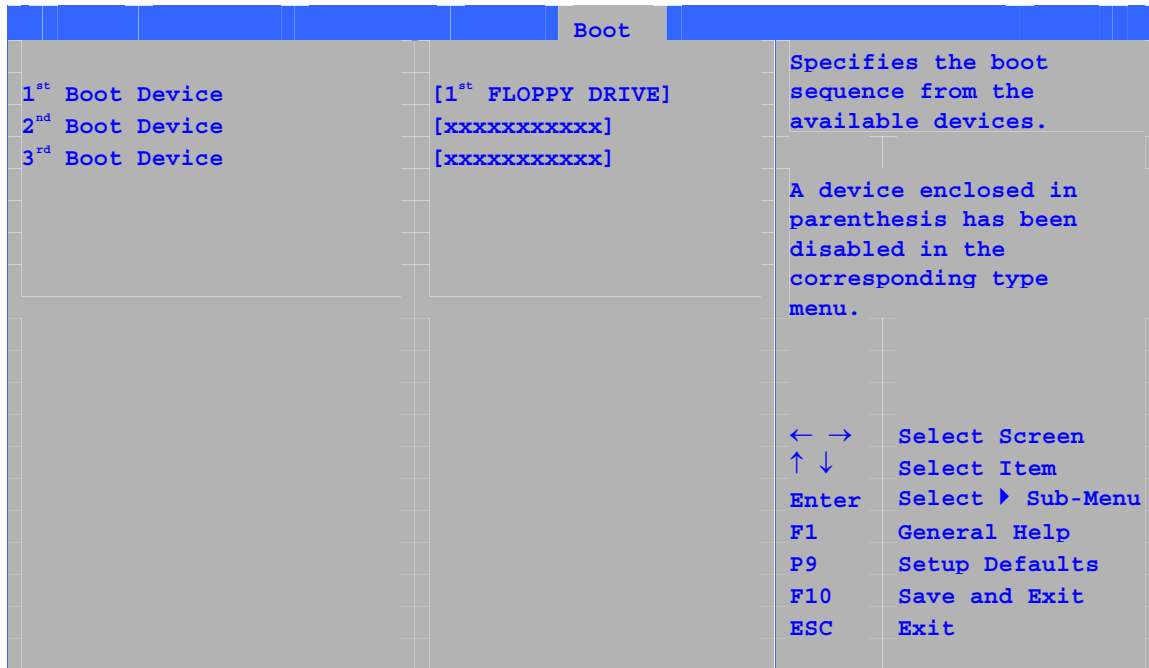

The submenu represented in Table 29 is for setting boot devices priority.

Table 29. Boot Device Priority Submenu

Feature	Options	Description
1 st Boot Device	<ul style="list-style-type: none"> Removable Device 	<p>Specifies the boot sequence from the available devices. To specify boot sequence:</p> <ol style="list-style-type: none"> Select the boot device with <↑> or <↓>. Press <Enter> to set the selection as the intended boot device. <p>The operating system assigns a drive letter to each boot device in the order listed. Changing the order of the devices changes the drive lettering. The default settings for the first through final boot devices are, respectively listed below. The BIOS supports up to sixteen total boot devices in any combination of the boot device types below, with respect to these maximums per type.</p> <ul style="list-style-type: none"> Removable Device (maximum of four). Hard Drive (maximum of 12). ATAPI CD-ROM (maximum of four).
2 nd Boot Device	<ul style="list-style-type: none"> Hard Drive 	
3 rd Boot Device	<ul style="list-style-type: none"> ATAPI CD-ROM Disabled 	

Hard Disk Drives Submenu

		Boot	
1 st Drive	[xxxxxxxxxxxx]		Specifies the boot sequence from the available devices. Select the boot device with UpArrow or DownArrow key. Press Enter to set the selections as the intended boot device. ARMD = ATAPI Removable Media Device.
2 nd Drive	[xxxxxxxxxxxx]		
3 rd Drive	[xxxxxxxxxxxx]		
4 th Drive	[xxxxxxxxxxxx]		
			← → Select Screen ↑ ↓ Select Item Enter Select ▶ Sub-Menu F1 General Help P9 Setup Defaults F10 Save and Exit ESC Exit

The submenu shown in Table 30 is for setting hard disk drives.

Table 30. Hard Disk Drives Submenu

Feature	Options	Description
1 st Hard Disk Drive (Note)	Dependent on installed hard drives	Specifies the boot sequence from the available hard disk drives. To specify boot sequence: <ol style="list-style-type: none"> Select the boot device with <↑> or <↓>. Press <Enter> to set the selection as the intended boot device.

Note: This boot device submenu appears only if at least one boot device of this type is installed. This list will display up to twelve hard disk drives, the maximum number of hard disk drives supported by the BIOS.

Removable Devices Submenu

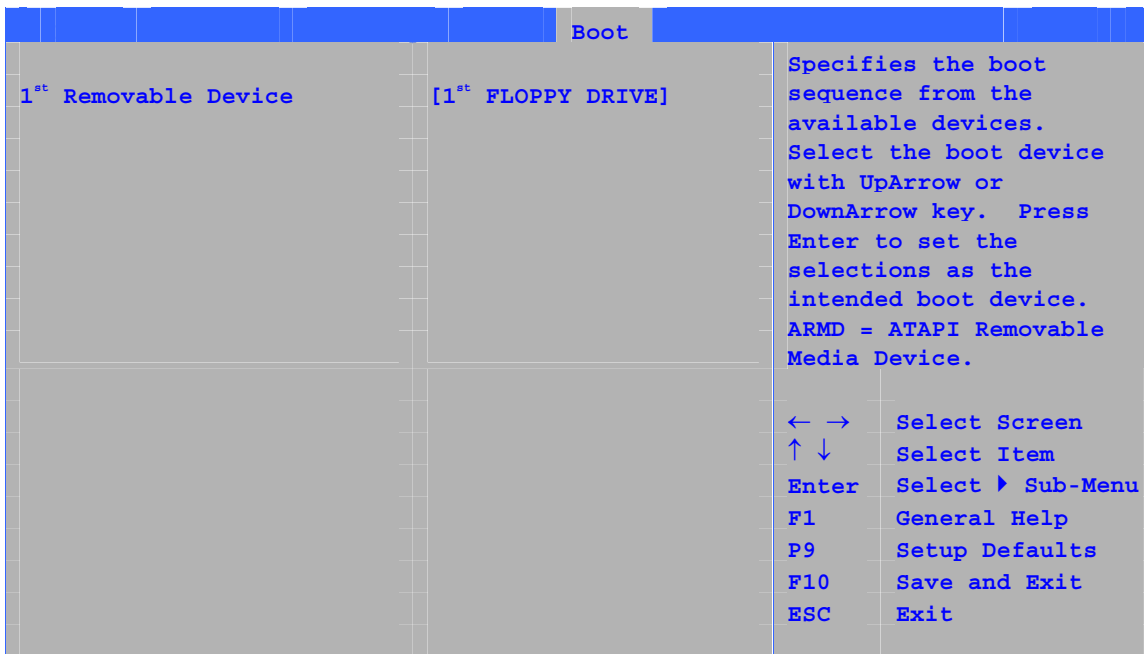

The submenu in shown Table 31 is for setting removable devices.

Table 31. Removable Devices Submenu

Feature	Options	Description
1 st Removable Device (Note)	Dependent on installed removable devices	Specifies the boot sequence from the available removable devices. To specify boot sequence: <ol style="list-style-type: none"> 1. Select the boot device with <↑> or <↓>. 2. Press <Enter> to set the selection as the intended boot device.

Note: This boot device submenu appears only if at least one boot device of this type is installed. This list will display up to four removable devices, the maximum number of removable devices supported by the BIOS.

ATAPI CD-ROM Drives

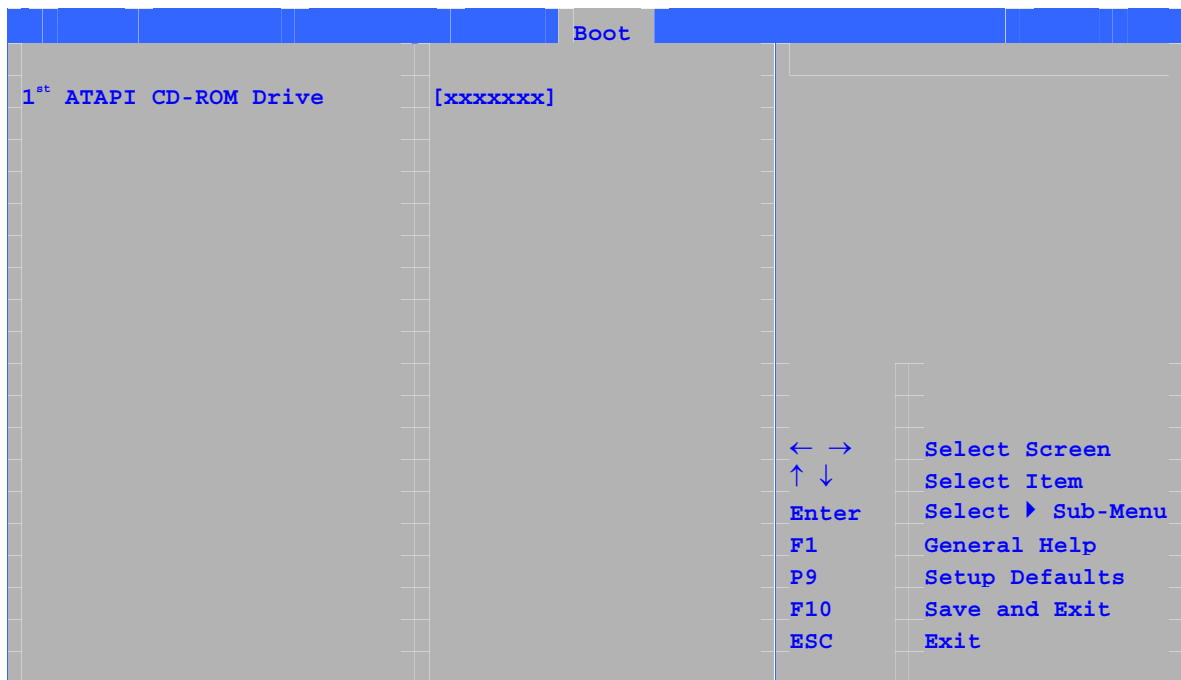

The submenu shown in Table 32 is for setting ATAPI CD-ROM drives.

Table 32. ATAPI CD-ROM Drives Submenu

Feature	Options	Description
1 st ATAPI CD-ROM Drive (Note)	Dependent on installed ATAPI CD-ROM drives	Specifies the boot sequence from the available ATAPI CD-ROM drives. To specify boot sequence: <ol style="list-style-type: none"> 1. Select the boot device with <↑> or <↓>. 2. Press <Enter> to set the selection as the intended boot device.

Note: This boot device submenu appears only if at least one boot device of this type is installed. This list will display up to four ATAPI CD-ROM drives, the maximum number of ATAPI CD-ROM drives supported by the BIOS.

Exit Menu

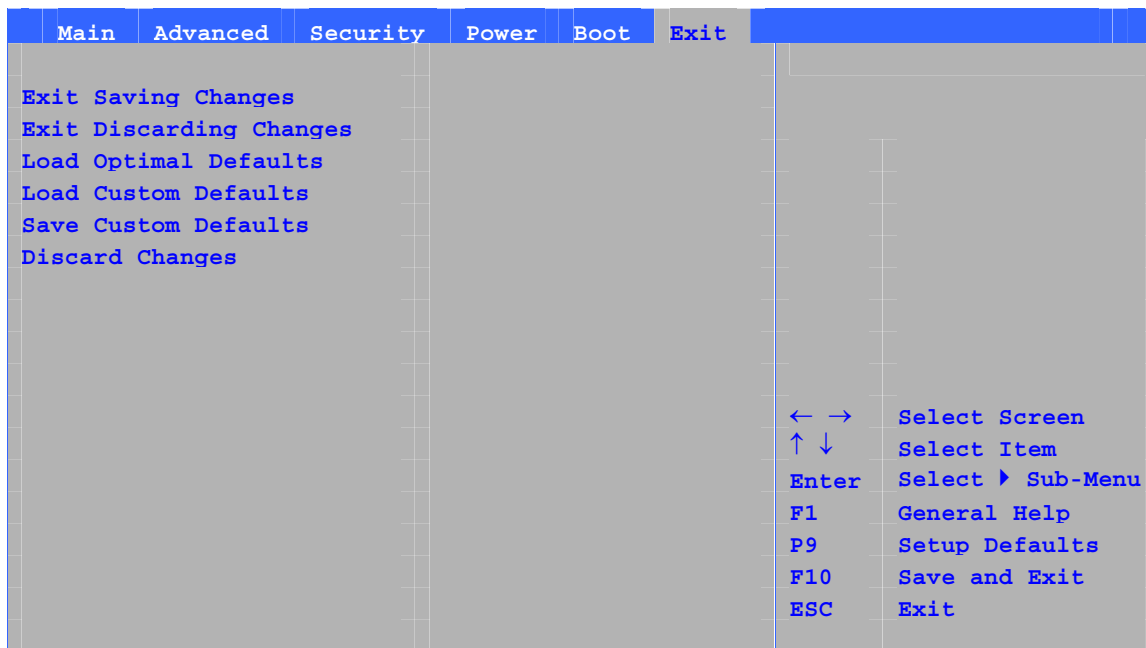

The menu shown in Table 33 is used to exit the BIOS Setup program, saving changes, and loading and saving defaults.

Table 33. Exit Menu

Feature	Description
Exit Saving Changes	Exits and saves the changes in CMOS SRAM.
Exit Discarding Changes	Exits without saving any changes made in the BIOS Setup program.
Load Optimal Defaults	Loads optimal defaults.
Load Custom Defaults	Loads the custom defaults for Setup options.
Save Custom Defaults	Saves the current values as custom defaults. Normally, the BIOS reads the Setup values from flash memory. If this memory is corrupted, the BIOS reads the custom defaults. If no custom defaults are set, the BIOS reads the factory defaults.
Discard Changes	Discards changes without exiting Setup. The option values present when the computer was turned on are used.

5 Desktop Board Resources

Memory Map

Table 34. System Memory Map

Address Range (decimal)	Address Range (hex)	Size	Description
1024 K - 2097152 K	100000 - 7FFFFFFF	2047 MB	Extended Memory
960 K - 1024 K	F0000 - FFFFF	64 KB	Runtime BIOS
896 K - 960 K	E0000 - EFFFF	64 KB	Reserved
800 K - 896 K	C8000 - DFFFF	96 KB	Available high DOS memory (open to the PCI bus)
640 K - 800 K	A0000 - C7FFF	160 KB	Video memory and BIOS
639 K - 640 K	9FC00 - 9FFFF	1 KB	Extended BIOS data (movable by memory manager software)
512 K - 639 K	80000 - 9FBFF	127 KB	Extended conventional memory
0 K - 512 K	00000 - 7FFFF	512 KB	Conventional memory

DMA Channels

Table 35. DMA Channels

DMA Channel Number	Data Width	System Resource
0	8 or 16 bits	
1	8 or 16 bits	Parallel port
2	8 or 16 bits	Diskette drive
3	8 or 16 bits	Parallel port (for ECP or EPP)
4	8 or 16 bits	DMA controller
5	16 bits	Open
6	16 bits	Open
7	16 bits	Open

Interrupts

Table 36. Interrupts

IRQ	System Resource
NMI	I/O channel check
0	Reserved, interval timer
1	Reserved, keyboard buffer full
2	Reserved, cascade interrupt from slave PIC
3	COM2*
4	COM1*
5	LPT2 (Plug & Play option) / **
6	Diskette drive controller
7	LPT1*
8	Real time clock
9	**
10	**
11	**
12	Onboard mouse port (if present, else user available)
13	Reserved, math coprocessor
14	Primary IDE (if present, else user available)
15	Secondary IDE (if present, else user available)

* Default, but can be changed to another IRQ.

** Dynamically allocated for all PCI/AGP devices and slots.

A Error Messages and Indicators

Desktop Board D845GVSR reports POST errors in two ways:

- By sounding a beep code
- By displaying an error message on the monitor

BIOS Beep Codes

The BIOS beep codes are listed in Table 37. The BIOS also issues a beep code (one long tone followed by two short tones) during POST if the video configuration fails (a faulty video card or no card installed) or if an external ROM module does not properly checksum to zero.

Table 37. Beep Codes

Number of Beeps	Description
1	Refresh failure
2	Parity cannot be reset
3	First 64 K memory failure
4	Timer not operational
5	Processor failure (Reserved; not used)
6	8042 GateA20 cannot be toggled (memory failure or not present)
7	Exception interrupt error
8	Display memory R/W error
9	(Reserved; not used)
10	CMOS Shutdown register test error
11	Invalid BIOS (such as, POST module not found)

BIOS Error Messages

When a recoverable error occurs during the POST, the BIOS displays an error message describing the problem.

Table 38. BIOS Error Messages

Error Message	Explanation
GA20 Error	An error occurred with Gate-A20 when switching to protected mode during the memory test.
Pri Master HDD Error Pri Slave HDD Error Sec Master HDD Error Sec Slave HDD Error	Could not read sector from corresponding drive.
Pri Master Drive - ATAPI Incompatible Pri Slave Drive - ATAPI Incompatible Sec Master Drive - ATAPI Incompatible Sec Slave Drive - ATAPI Incompatible	Corresponding drive is not an ATAPI device. Run Setup to make sure device is selected correctly.
A: Drive Error B: Drive Error	No response from the diskette drive.
CMOS Battery Low	The battery may be losing power. Replace the battery soon.
CMOS Display Type Wrong	The display type is different than what has been stored in CMOS. Check Setup to make sure type is correct.
CMOS Checksum Bad	The CMOS checksum is incorrect. CMOS memory may have been corrupted. Run Setup to reset values.
CMOS Settings Wrong	CMOS values are not the same as the last boot. These values have either been corrupted or the battery has failed.
CMOS Date/Time Not Set	The time and/or date values stored in CMOS are invalid. Run Setup to set correct values.
DMA Error	Error during read/write test of DMA controller.
FDC Failure	Error occurred trying to access diskette drive controller.
HDC Failure	Error occurred trying to access hard disk controller.
Checking NVRAM.....	NVRAM is being checked to see if it is valid.
Update OK!	NVRAM was invalid and has been updated.
Updated Failed	NVRAM was invalid but was unable to be updated.
Keyboard Is Locked	The system keyboard lock is engaged. The system must be unlocked to continue to boot.
Keyboard Error	Error in the keyboard connection. Make sure keyboard is connected properly.
KB/Interface Error	Keyboard interface test failed.

continued

Table 38. BIOS Error Messages (continued)

Error Message	Explanation
Memory Size Decreased	Memory size has decreased since the last boot. If no memory was removed, then memory may be bad.
Memory Size Increased	Memory size has increased since the last boot. If no memory was added, there may be a problem with the system.
Memory Size Changed	Memory size has changed since the last boot. If no memory was added or removed, then memory may be bad.
No Boot Device Available	System did not find a device to boot.
Off Board Parity Error	A parity error occurred on an offboard card. This error is followed by an address.
On Board Parity Error	A parity error occurred in onboard memory. This error is followed by an address.
Parity Error	A parity error occurred in onboard memory at an unknown address.
NVRAM / CMOS / PASSWORD cleared by Jumper	NVRAM, CMOS, and passwords have been cleared. The system should be powered down and the jumper removed.
<CTRL_N> Pressed	CMOS is ignored and NVRAM is cleared. User must enter Setup.

B Regulatory Compliance

This appendix contains the following regulatory compliance information for Desktop Board D845GVSR:

- Safety regulations
- European Union Declaration of Conformity statement
- Product Ecology statements
- Electromagnetic Compatibility (EMC) regulations
- Product certification markings

Safety Regulations

Desktop Board D845GVSR complies with the safety regulations stated in Table 39 when correctly installed in a compatible host system.

Table 39. Safety Regulations

Regulation	Title
UL 60950 3 rd ed., 2000/CSA C22.2 No. 60950-00	Bi-National Standard for Safety of Information Technology Equipment including Electrical Business Equipment. (USA and Canada)
EN 60950:2000	The Standard for Safety of Information Technology Equipment including Electrical Business Equipment. (European Union)
IEC 60950, 3 rd Edition, 1999	The Standard for Safety of Information Technology Equipment including Electrical Business Equipment. (International)

European Union Declaration of Conformity Statement

We, Intel Corporation, declare under our sole responsibility that the product Intel® Desktop Board D845GVSR is in conformity with all applicable essential requirements necessary for CE marking, following the provisions of the European Council Directive 89/336/EEC (EMC Directive) and Council Directive 73/23/EEC (Safety/Low Voltage Directive).

The product is properly CE marked demonstrating this conformity and is for distribution within all member states of the EU with no restrictions.



This product follows the provisions of the European Directives 89/336/EEC and 73/23/EEC.

Dansk Dette produkt er i overensstemmelse med det europæiske direktiv 89/336/EEC & 73/23/EEC.

Dutch Dit product is in navolging van de bepalingen van Europees Directief 89/336/EEC & 73/23/EEC.

Suomi Tämä tuote noudattaa EU-direktiivin 89/336/EEC & 73/23/EEC määräyksiä.

Français Ce produit est conforme aux exigences de la Directive Européenne 89/336/EEC & 73/23/EEC.

Deutsch Dieses Produkt entspricht den Bestimmungen der Europäischen Richtlinie 89/336/EEC & 73/23/EEC.

Icelandic Þessi vara stenst reglugerð Evrópska Efnahags Bandalagsins númer 89/336/EEC & 73/23/EEC.

Italiano Questo prodotto è conforme alla Direttiva Europea 89/336/EEC & 73/23/EEC.

Norsk Dette produktet er i henhold til bestemmelsene i det europeiske direktivet 89/336/EEC & 73/23/EEC.

Portuguese Este produto cumpre com as normas da Diretiva Européia 89/336/EEC & 73/23/EEC.

Español Este producto cumple con las normas del Directivo Europeo 89/336/EEC & 73/23/EEC.

Svenska Denna produkt har tillverkats i enlighet med EG-direktiv 89/336/EEC & 73/23/EEC.

Product Ecology Statements

The following information is provided to address worldwide product ecology concerns and regulations.

Disposal Considerations

This product contains the following materials that may be regulated upon disposal: lead solder on the printed wiring board assembly.

Recycling Considerations

Intel encourages its customers to recycle its products and their components (e.g., batteries, circuit boards, plastic enclosures, etc.) whenever possible. In the U.S., a list of recyclers in your area can be found at:

<http://www.eiae.org>

In the absence of a viable recycling option, products and their components must be disposed of in accordance with all applicable local environmental regulations.

EMC Regulations

Desktop Board D845GVSR complies with the EMC regulations stated in Table 40 when correctly installed in a compatible host system.

Table 40. EMC Regulations

Regulation	Title
FCC Class B	Title 47 of the Code of Federal Regulations, Parts 2 and 15, Subpart B, Radio Frequency Devices. (USA)
ICES-003 (Class B)	Interference-Causing Equipment Standard, Digital Apparatus. (Canada)
EN55022: 1998 (Class B)	Limits and methods of measurement of Radio Interference Characteristics of Information Technology Equipment. (European Union)
EN55024: 1998	Information Technology Equipment – Immunity Characteristics Limits and methods of measurement. (European Union)
AS/NZS 3548 (Class B)	Australian Communications Authority, Standard for Electromagnetic Compatibility. (Australia and New Zealand)
CISPR 22, 3 rd Edition, (Class B)	Limits and methods of measurement of Radio Disturbance Characteristics of Information Technology Equipment. (International)
CISPR 24: 1997	Information Technology Equipment – Immunity Characteristics – Limits and Methods of Measurement. (International)



Korean Class B statement translated as follows: this is household equipment that is certified to comply with EMC requirements. You may use this equipment in residential environments and other non-residential environments.

이 기기는 가정용으로 전자파적합등록을 한 기기로서
주거지역에서는 물론 모든 지역에서 사용할 수 있습니다.

Product Certification Markings (Board Level)

Desktop Board D845GVSR has the following product certification markings:

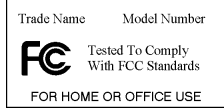
Table 41. Product Certification Markings

Description	Mark
UL joint US/Canada Recognized Component mark. Includes adjacent UL file number for Intel desktop boards: E210882 (component side).	
FCC Declaration of Conformity logo mark for Class B equipment; includes Intel name and D845GVSR model designation (component side).	
CE mark. Declares compliance to European Union (EU) EMC directive (89/336/EEC) and Low Voltage directive (73/23/EEC) (component side). The CE mark should also be on the shipping container.	
Australian Communications Authority (ACA) C-tick mark. Includes adjacent Intel supplier code number, N-232. The C-tick mark should also be on the shipping container.	
Printed wiring board manufacturer's recognition mark: consists of a unique UL recognized manufacturer's logo, along with a flammability rating (solder side).	94V-0